

UrbanPond[®] Installation Manual



**URBANPOND
INSTALLATION MANUAL
TABLE OF CONTENTS**

OVERVIEW	3
SAFETY NOTICE AND PERSONAL SAFETY EQUIPMENT.....	4
URBANPOND COMPONENTS LIST	5
INSTALLATION EQUIPMENT LIST	6
INSTALLATION MATERIALS LIST	7
EXCAVATION PROCESS	8
SITE ACCESS	8
EXCAVATION	8
DEWATERING	8
REMOVAL OF ROCK AND UNSTABLE MATERIALS	9
SUBGRADE, BEDDING, AND FOUNDATION	9
SUBGRADE	9
BEDDING.....	9
FOUNDATION	10
DELIVERY, STORAGE, AND HANDLING.....	11
SAFETY	11
DELIVERY.....	11
STORAGE	13
HANDLING	13
MODULE INSTALLATION	16
PREPARE FOR INSTALLATION	16
INSPECT MODULES UPON ARRIVAL	16
MONO ON CONCRETE SLAB INSTALLATION	17
STACKED CONFIGURATION INSTALLATION	19
PIPE CONNECTIONS	22
SILT-TIGHT.....	22
WATER-TIGHT	22
BACKFILL AND FINAL FILL	23
BACKFILL	23
FINAL FILL	23

OVERVIEW

UrbanPond is an underground modular storage system designed for stormwater detention and infiltration. UrbanPond utilizes the strength and durability of precast concrete to create an efficient and resilient stormwater management solution. A modular design gives UrbanPond the flexibility to meet nearly any site requirements with configurations ranging from 3' to 14' inside height. Modules are delivered ready to be installed, minimizing staging requirements and decreasing installation times.

UrbanPond can be installed in a variety of configurations and heights. Taller systems are installed stacked with top and inverted bottom modules. Shorter systems consist of the top modules only placed upon a concrete slab. Either configuration can be combined with a membrane liner for leak resistant applications. Installation procedures for both configurations are described herein.

The Engineer of Record is responsible for the approval of the system design, layout, and volume to be stored, as well as load calculations, cover depth, water table elevation, soils report, and backfill requirements. This installation manual is a reference guide only.

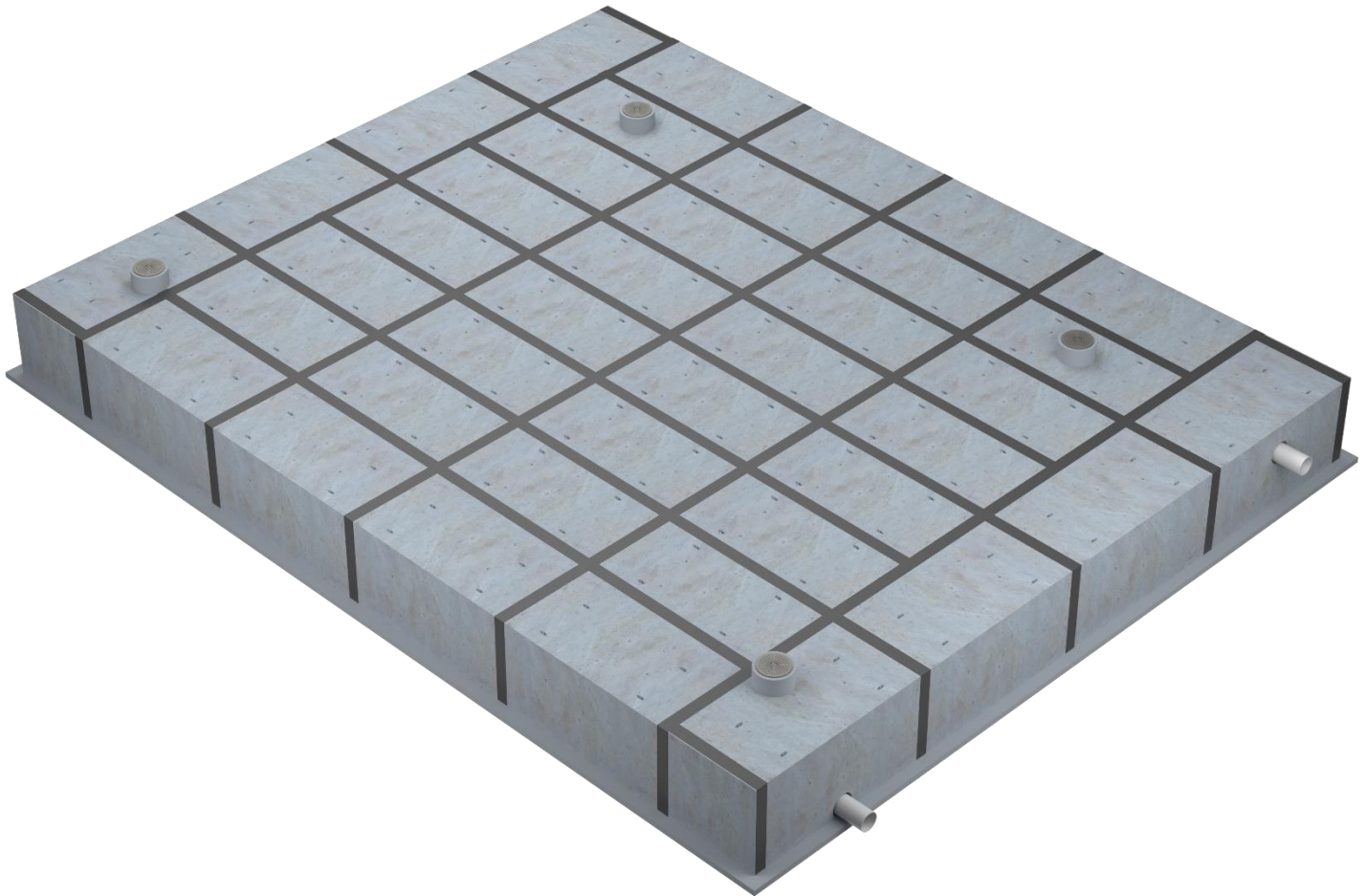

SAFETY NOTICE AND PERSONAL SAFETY EQUIPMENT

Job site safety is a topic and a practice addressed comprehensively by others. The inclusions here are merely reminders to whole areas of Safety Practice that are the responsibility of the Owner(s), Manager(s), and Service Provider(s). OSHA and Canadian OSH, Federal, State/Provincial, and Local Jurisdiction Safety Standards apply on any given site or project. The knowledge and applicability of those responsibilities is the Service Provider's responsibility and outside the scope of Contech Engineered Solutions.



Fall Protection Equipment



Safety Boots



Gloves



Hard Hat



Eye Protection



Ear Protection



Ventilation and Respiratory Protection



Maintenance and Protection of Traffic Plan

URBANPOND COMPONENTS LIST

The UrbanPond system is constructed of multiple modules and panel walls. The system configuration will be shown in the Shop Drawings or Plans and may include:



8x8 Interior Module



8x8 Perimeter Module



Wall Panel



8x16 Interior Module



8x16 Perimeter Module

INSTALLATION EQUIPMENT LIST

The following equipment is recommended to facilitate installation of the UrbanPond system. This list is not all-inclusive and comprises general recommendations.



Personal Protective Equipment (PPE)



Earth Moving Equipment



Crane



Compaction Equipment



Spider/Scissor/Boom Lift



Lifting Shackles or Hooks



Lift Chains or Straps



Pry Bars or "Spud" Bars



60" Spirit Level



Shovel



Transit Level or Laser Level



Extension Ladders (8ft to 16ft)



Chalk Line and/or Mason's String



Spray Paint



Tape Measure



Box Knife



Contractor's Broom



Impact Driver or Ratchet with 15/16" and 13/16" Sockets



Hammer Drill with 5/8" Concrete Bit



Hammer

INSTALLATION MATERIALS LIST

The following materials are necessary for installation of the UrbanPond system. This list is not all-inclusive and comprises general recommendations. Additional materials may be required depending on the system type and installation conditions.

Provided by Contech:

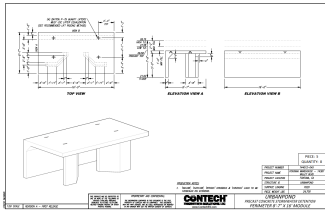

Shop Drawings



ConSeal CS-213
Geotextile Backed Exterior
Joint Wrap



ConSeal CS-102
Butyl-Rubber Sealant



Fiber Reinforced Wall Shims



Hilti Kwik Bolt TZ2
Wedge Anchors
5/8" x 10"



Hilti HAS-V-36
Anchor Rod
5/8" x 8"



Hilti Threaded Rod Coupler
5/8" x 2-1/8"



Square Plate Washer
ASTM A572 Gr 50
3/8 x 4 x 4

Provided by Contractor:



Bedding Material



Backfill Material



ASTM C1107
Non-Shrink Grout



Non-Woven Geotextile

EXCAVATION PROCESS

Excavation for the UrbanPond system should be in accordance with the Project Plans and Specifications. The excavation should consider various factors such as system length, width, depth, and type, as well as any site constraints such as access, water table, stockpile, borrow, and unit staging and placement locations.

SITE ACCESS

The excavation process will create a large amount of material that needs to be stored on site or exported from the site. Planning and preparation for this amount of material is necessary. The bottom of the excavation will need to be accessible for placement and preparation of the bedding as well as movement and placement of the modules. This often requires a ramp into the excavation or cutting the excavation in such a manner that one side is accessible from grade level.

Modules may be placed directly from truck or staged and placed from the site. In either case, adequate room for large truck access, location of a crane, and staging of the modules is necessary.

EXCAVATION

Excavate the installation area to ensure that the sides will be stable under all working conditions. To achieve this, trench walls may have to be sloped, stepped, or supported with temporary or permanent shoring. The trench walls should be prepared in conformance with all federal, state, and local safety standards. Excavate only as much as can be safely maintained by available equipment.

The excavation dimensions should be based on the Project Plans and Specifications and any approved submittal drawing prepared by Contech. Excavation lengths and widths should allow for adequate amounts of backfill material and appropriate compaction equipment. Where excavation walls are stable or supported, the width of the excavation should be no greater than necessary to ensure working room to properly and safely place and compact embedment materials. This is generally considered as 18 to 24 inches, but this may vary depending on the backfill material and compaction equipment utilized. The space between the stormwater storage system and excavation wall must be wider than the compaction equipment used in the compaction area.

DEWATERING

The precast modules and concrete slab foundation should not be placed or poured in standing or running water. Groundwater must be properly managed and surface runoff should be prevented from entering the excavation at all times.

If water is present in the work area, the excavation must be dewatered to maintain the stability of the in-situ and imported materials. The water level must be maintained below the stormwater storage system bedding and foundation to provide a stable excavation bottom. Use, as appropriate, sump pumps, well points, deep wells, geofabrics, perforated underdrains, or stone blankets of sufficient thickness to remove and control water in the excavation. When excavating while depressing ground water, ensure the ground water is below the bottom of cut at all times to prevent washout from behind sheeting or sloughing of exposed excavation walls. Maintain control of water in the excavation before, during, and after the stormwater storage system installation and until embedment is installed and sufficient backfill has been placed to prevent flotation of the system, attached piping, or accessory drainage structures.

REMOVAL OF ROCK AND UNSTABLE MATERIALS

Rock in either ledge or boulder formation should be removed and replaced with suitable material to provide a compacted earth cushion having a thickness between exposed rock and the stormwater storage system of at least 12 inches.

Where wet or otherwise unstable soil incapable of properly supporting the stormwater storage system, as determined by the Engineer, is encountered in the bottom of an excavation, such material should be removed to at least 24 inches below the bottom of the system and replaced to the proper grade with select granular material, compacted as directed by the Engineer.

SUBGRADE, BEDDING, AND FOUNDATION

The bedding for the UrbanPond system should be in accordance with the Project Plans and Specifications. A stable and uniform bedding and foundation is necessary for the stormwater storage system and any associated features. The bedding material and placement method can vary depending on the site conditions and the system type. Storage system foundations may be precast or poured in place depending on the system design.

SUBGRADE

The UrbanPond system requires a foundation that is stable, uniform, and level to slightly sloped. This begins with preparation of the subgrade. The subgrade should be prepared in accordance with the Project Plans and Specifications. Grade the foundation subgrade to a uniform and level to slightly sloping ($\leq 1\%$) grade surface. If the subgrade is clay or a relatively non-porous material and the construction sequence will last for an extended period of time, it is best to slope the grade to one end of the system. This will allow excess water to drain quickly, preventing saturation of the subgrade.

BEDDING

The bedding for the UrbanPond system provides a structural and hydraulic connection to the subgrade. The material type and placement are critical to the performance of the system. Detention and Infiltration systems require different types of bedding.

The bedding layer thickness and material type are based on the subgrade material type, storage system type, and required soil bearing pressure. Refer to the plans/drawings for project specific details. Specific projects may require higher bearing pressures, and this should be confirmed prior to selection of the bedding material type.

Infiltration systems require a poorly graded bedding material to allow incoming water to pass through to the subgrade and in-situ material. Detention systems can utilize a broader range of materials including poorly graded and well graded materials.

The bedding material for an UrbanPond infiltration system should consist of borrow that conforms to ASTM D2487 group GP or SP. These materials are typically washed granular material such as 3/4" rock or washed sand.

EXAMPLES OF ACCEPTABLE BEDDING MATERIAL



Coarse Sand



Crushed Limestone



Crushed Granite



Crushed River Gravel

The bedding material for an UrbanPond detention system should consist of a native material or borrow that conforms to ASTM D2487 except group OL, CH, MH, OH, and PT. Material from the excavation, provided it conforms to one of the acceptable groups, can be utilized for detention system bedding.

The bedding should be a minimum of 6 inches thick and should be graded to within 1/4" of Plan grade. The bedding should extend a minimum of 12 inches beyond the UrbanPond system dimensions as shown in the Plans or Shop Drawings. The bedding should be compacted to a minimum of 90% of maximum density per AASHTO T99, or as shown in the Plans utilizing equipment and methods appropriate for the selected material.

Any open graded materials utilized for bedding should be separated from the in-situ material by a non-woven geotextile conforming to AASHTO M228, Class 2.

EXAMPLE SYSTEM CROSS-SECTION

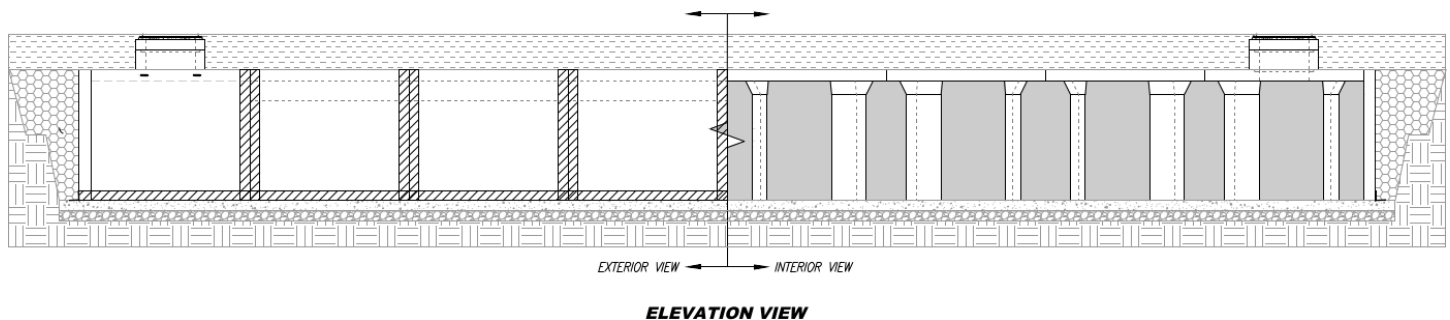

FOUNDATION

The foundation for the UrbanPond system can be either constructed on site or precast depending on the system design. A poured-in-place concrete slab serves as the foundation for the mono UrbanPond system while the lower module of the stacked UrbanPond system serves as the precast foundation. Mono systems will be set directly on stone in infiltration applications.

The design of the poured-in-place concrete slab should be per the Project Plans and Specifications. The foundation slab dimensions should be considered when preparing the excavation, subgrade, and bedding. The foundation slab should extend beyond the footprint of the UrbanPond modules by 1 foot (12") on all sides of the system. Final site-specific design of the foundation slab is the responsibility of the Engineer and/or Contractor.

DELIVERY, STORAGE, AND HANDLING

The installation process begins with delivery of the UrbanPond precast concrete components. Proper planning for the delivery, storage, and handling of the system will ensure a safe and efficient installation.

SAFETY

Contech considers safety a priority for all construction projects. It is important for all parties involved with the installation of the UrbanPond system to observe all regulations and practice safety requirements during all aspects of the installation including delivery, unloading, handling, storage, and placement.

Safe practices in construction work as outlined in the latest edition of the "Manual of Accident Prevention in Construction," published by the Associated General Contractors, should be used as a guide and observed. The contractor should comply with all applicable city, state, and federal safety codes in effect in the area where work is being performed. This conformance should include the provisions of the current issue of the "OSHA Safety and Health Standards (29 CFR 1926/1910)" as published by the U.S. Department of Labor.

The UrbanPond modules should only be lifted using the appropriate lifting equipment and rigging, and this rigging should be properly fitted to the designated lift points of the modules. All rigging equipment should be certified to lift the specific weight and identified as such in permanent marking. All rigging should be inspected prior to use. The weight of the UrbanPond modules will vary depending on type. Weights will be clearly marked on the precast units and on the Shop Drawings.

All lifting and placement must proceed with caution and strictly in accordance with all relevant occupational health and safety standards. Bumping or impact of modules can cause damage and should be avoided.

The contractor is responsible for the safety of his/her employees and agents.

DELIVERY

A preconstruction meeting will be held prior to any delivery of material for the UrbanPond system installation. During the meeting, shipping plans will be finalized which will include a sequencing of the module delivery and placement. Proper sequencing should be a consideration for installation directly from the truck to the excavation as well as installation from an on-site staged or stored location.

The shipping plan will help to alleviate multiple handlings of the modules, which will reduce the time and effort required for the installation. The shipping plan will also make efficient use of the installation equipment (crane) and reduce congestion on the construction site. The shipping plan will be provided to the Contractor for review and approval prior to shipment of any material to the job site.

EXAMPLE DELIVERY SEQUENCE

DELIVERY PLAN

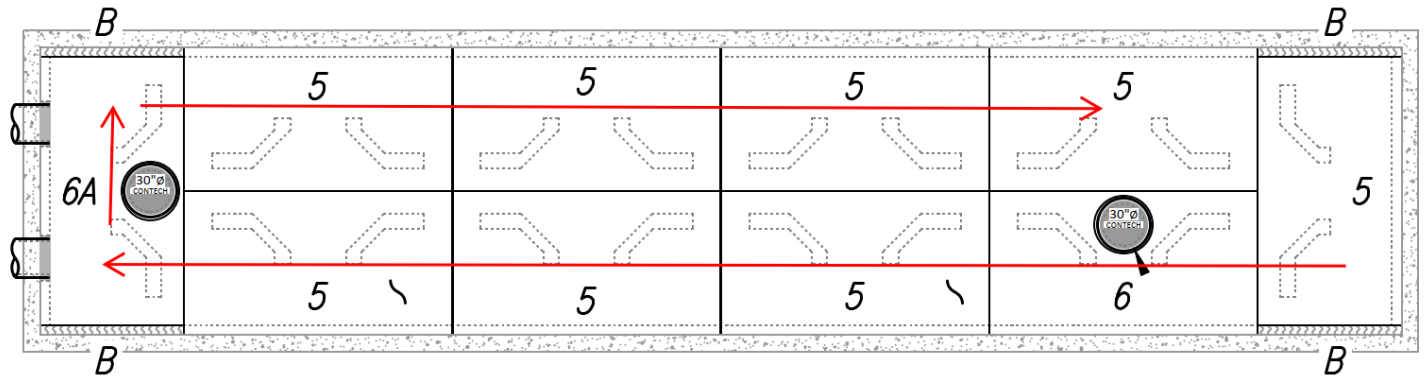

The UrbanPond modules will be delivered to the job site on a flat-bed trailer. Each truck typically contains between one and four modules, but the quantity will vary based on the module size and weight. The first truck of modules typically takes the longest to unload and place. Subsequent truck deliveries typically require less time to offload and place but can vary based on job site conditions.

EXAMPLE DELIVERY

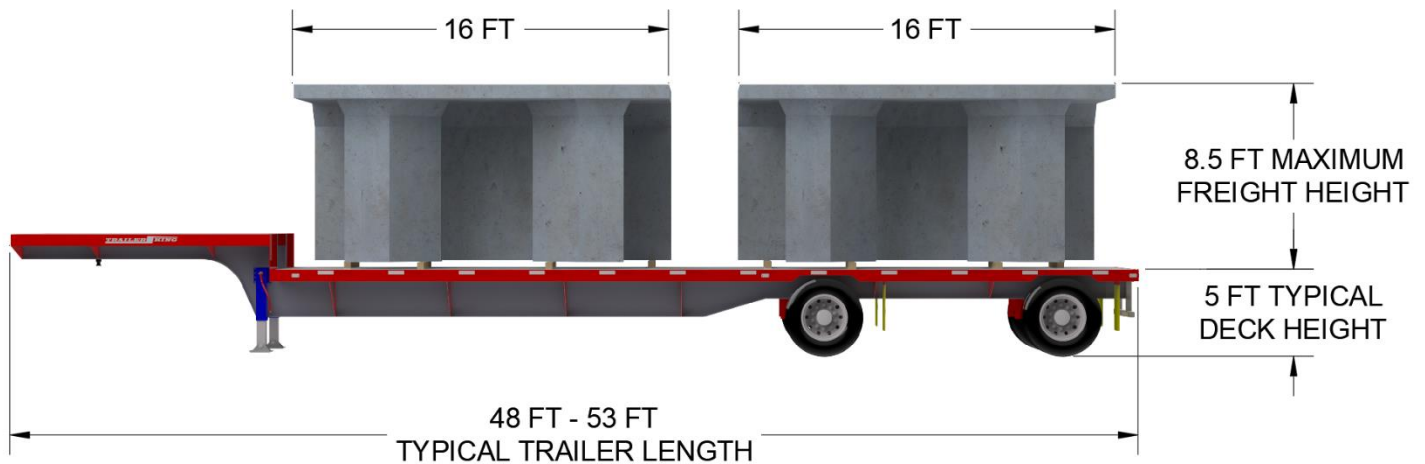

Mono and upper modules will be delivered right side up. Lower modules are inverted at the manufacturing plant and are placed on the truck oriented correctly for direct installation. No flipping or turning of any of the modules is necessary.

STORAGE

The UrbanPond modules may have to be stored on site temporarily or for extended periods of time. Modules should be stored adequately to prevent cracking, warping, or distortion. Modules should be stored on a firm and level foundation to avoid or minimize product damage. The use of dunnage is the preferred method for storage. Dunnage should be positioned such that the product is level, the load is evenly distributed, and sufficient bearing area is provided to prevent damage to the concrete. For mono or upper modules this means dunnage must be placed under all legs and walls. For lower modules and wall panels, dunnage must be placed evenly beneath the slab. Dunnage should be tall enough to allow for lifting from beneath the module. Modules should not be stacked on one another.

Accessory components will be delivered to the job site in the manufacturer's original, unopened packaging and/or containers, with labels that clearly identify the manufacturer and part number of the component. Accessory components should remain in the original manufacturer's packaging until the item(s) have been inspected and are ready for installation.

Accessory components should be stored in a clean, dry area out of direct sunlight until such time that the component is to be utilized.

EXAMPLES OF PROPER STORAGE

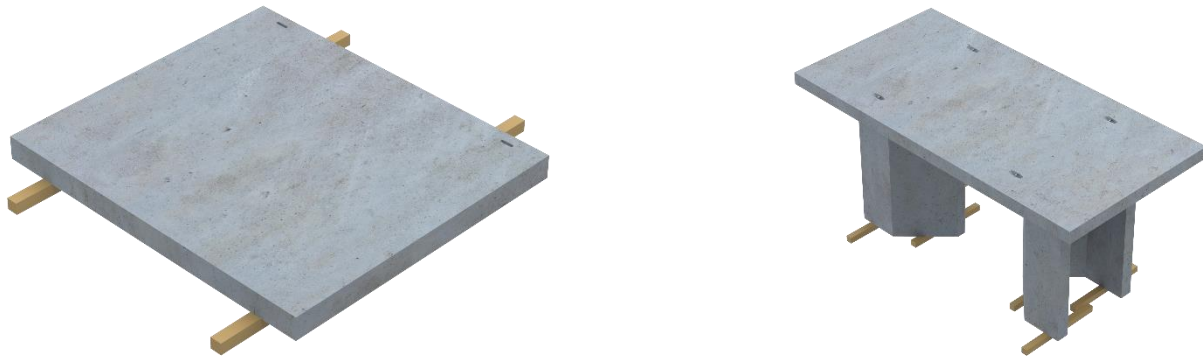

HANDLING

The UrbanPond modules should be handled in such a manner to prevent damage to the components and to prevent injury or death. The precast components are supplied with cast-in lift anchors to ensure safe and proper handling. Some components may be handled with forked equipment, but proper care and techniques must be utilized to prevent damage, injury, or death.

UrbanPond modules will not be shipped to the job site until the concrete has achieved full design strength, thus ensuring all components can be safely handled and installed directly into the excavation. Whenever possible, all components should be installed directly from the delivery truck into the excavation.

UrbanPond modules are supplied with cast-in utility anchors ("A-anchors"). These anchors are designed to be used with standard hooks or shackles. The utility anchor uses a recess plug to create a void in the concrete. The concrete void is sufficiently large enough to accept a 6-ton Grade 8 alloy hook or a 7-ton forged alloy shackle.

UrbanPond wall modules are supplied with cast-in coil lift inserts or Raise and Set lifters. The cast-in coil lift inserts are designed to be utilized with lifting plates and lifting bolts as shown on the next page. The Raise and Set lifters require a cable bail ring clutch.

WALL PANEL LIFTER DETAILS

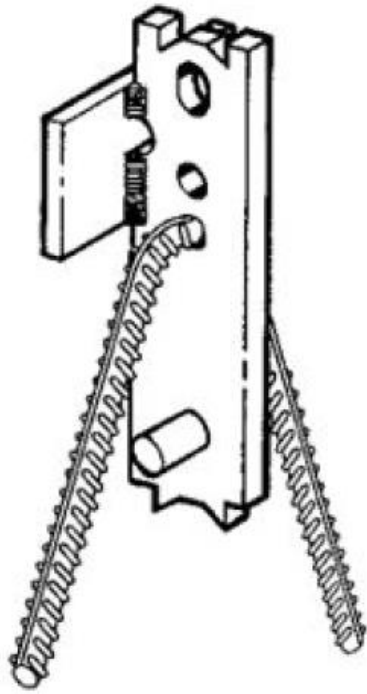

P92P FL149 Erection Anchor

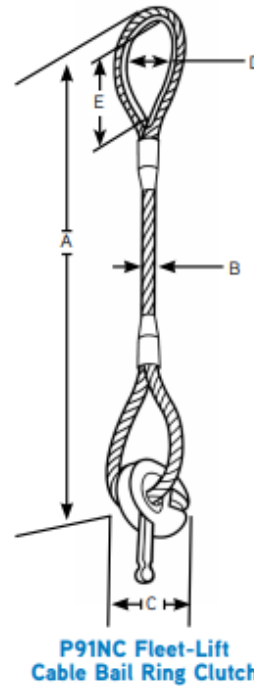

P91NC Fleet-Lift
Cable Bail Ring Clutch

P91NC Cable Bail Ring Clutch

The UrbanPond modules should be rigged in such a manner that loads are balanced and equalized. This may require the use of spreader bars, roller blocks, or other rigging means that will evenly distribute the load across all lift anchors. Examples of rigging are shown below. At no time should the rigging be connected to a precast component under load and the angle of the sling or chain be less than 60 degrees from horizontal. Failure to do so may result in an increased load that is beyond the capacity of the lifter and/or concrete.

EXAMPLE RIGGING METHODS

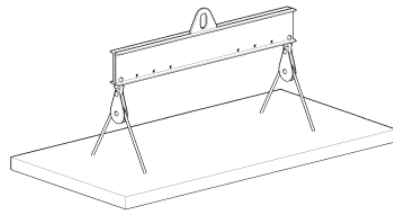
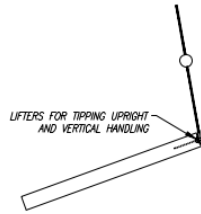

* RECOMMENDED EQUALIZED LIFT RIGGING METHOD
PIECE 5, 6

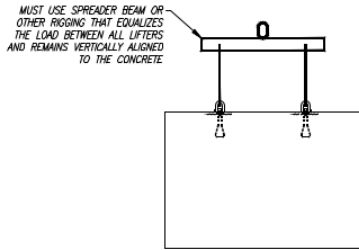

EXTERIOR WALL PANEL

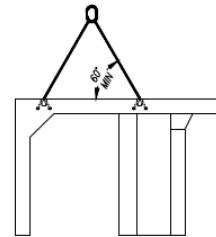

* SINGLE PERIMETER MODULE

Installers should use rigging that is adequately rated for the precast component being lifted, and all rigging should be clearly marked with capacity ratings. It is the Contractor's responsibility to ensure the necessary rigging equipment is available at the time of delivery and installation. The Contech Shop Drawings will include a detail for each concrete component detailing the exact configuration and pick weight so that the Contractor can pre-plan for the rigging.

EXAMPLE OF SHOP DRAWINGS

(4) DAVTON 10-75 SQUARE LIFTERS MUST USE (AFTER EQUALIZATION) (SEE RECOMMENDED LIFT RIGGING METHOD)

VIEW B

VIEW A

TOP VIEW

PROJ. FILE A 28.75
27.58
LOW T.E.

PRECAST TOP 26.58

21.00 FLOOR

ELEVATION VIEW A

ELEVATION VIEW B

	PIECE: 5 QUANTITY: 8
PROJECT NUMBER	744013-04S
PROJECT NAME	FONTANA WAREHOUSE - 14387 VALLEY BLVD
PROJECT LOCATION	FONTANA, CA
STRUCTURE ID	URBANPOND
SURFACE LOADING	HS20
PIECE WEIGHT LBS	24,700

CONTECH
ENGINEERED SOLUTIONS LLC
www.ContechES.com

URBANPOND
PRECAST CONCRETE STORMWATER DETENTION
PERIMETER 8'-7" X 16' MODULE

PRODUCTION NOTES:
1. "INFLOW", "OVERTFLOW", "BYPASS" OPENINGS & "CONTECH" LOGO TO BE STENCILED ON EXTERIOR.

THIS PRODUCT MAY BE PROTECTED BY ONE OR MORE OF THE FOLLOWING INTELLECTUAL PROPERTY RIGHTS: PATENTS, TRADEMARKS, COPYRIGHTS, AND/OR OTHER RIGHTS. THIS DOCUMENT IS THE PROPERTY OF CONTECH AND IS CONFIDENTIAL. NO PART OF THIS DOCUMENT IS TO BE REPRODUCED OR TRANSMITTED IN ANY MANNER WITHOUT THE WRITTEN CONSENT OF CONTECH.

MODULE INSTALLATION

The UrbanPond system is to be installed in general accordance with ASTM C891 "Standard Practice for Installation of Underground Precast Concrete Utility Structures". Where specific installation procedures are not indicated in this Referenced Specification or the Project Plans, the following guidelines should serve as the specific procedures for installation.

A representative from Contech will be present on site at the start of module installation to provide support to the Contractor and observe delivery and installation.

PREPARE FOR INSTALLATION

Ensure the following are complete before beginning installation. This can be done before the first delivery arrives.

- Clean Foundation (Mono Only) - Clear the concrete foundation of all equipment and material and sweep it clean of all debris.
- Clear Work Area - Clear the area in which the concrete components are to be offloaded, picked, and placed of all people not associated with the installation. Isolate the work area wherever possible using caution tape or other methods as necessary.
- Layout Installation - Confirm line and grade, then set chalk lines or string lines to mark the placement of all modules. Mark the location of the first module to be installed.
- Set Teams - Divide the installation crew into an unloading crew and a placement crew. This will help minimize entry and exit from the excavation.

INSPECT MODULES UPON ARRIVAL

All UrbanPond modules should be inspected for defects and cracks before being lifted from the delivery truck. Any nonconformance to approved drawings or damage to any part of the system shall be documented on the shipping ticket.

MONO ON CONCRETE SLAB INSTALLATION

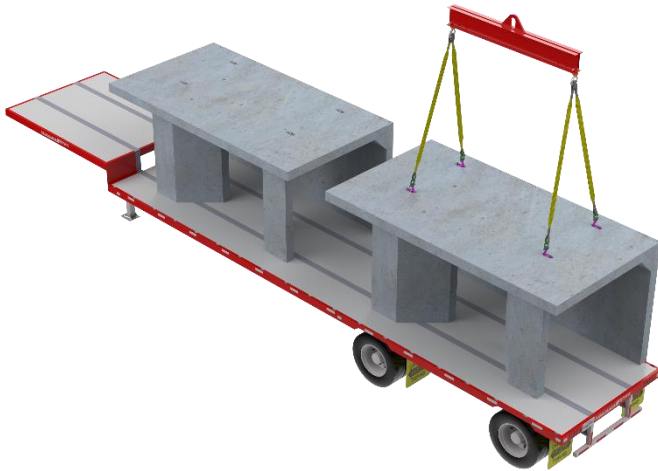

1. LIFT FIRST MODULE

Begin with a module in the corner of the system to ensure proper system alignment in the X and Y directions. Lift the module slowly and carefully, taking care to keep it away from other modules and equipment on site. Striking or bumping the modules should be avoided to prevent damage to the modules.

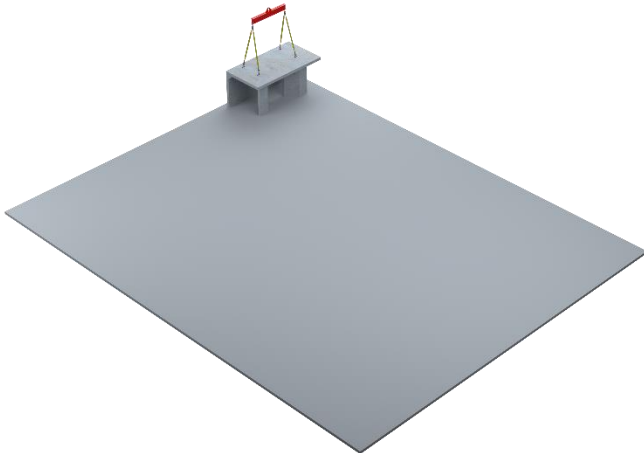

2. PLACE FIRST MODULE

Lower the module to within 1 inch of the foundation, then align it to the layout lines to ensure proper placement in the X and Y directions. Ensure the module is properly aligned and squared to the lines, then slowly lower the module the remaining distance to the slab. Confirm module placement is in accordance with the Plans, recheck for squareness, and finally check for level.

Modules should be placed to within $\pm 3/4"$ of the elevations as indicated on the Plans. Any module that has had its grade disturbed after placement should be removed and reset. Any defective, damaged, or unsound module should be removed and replaced.

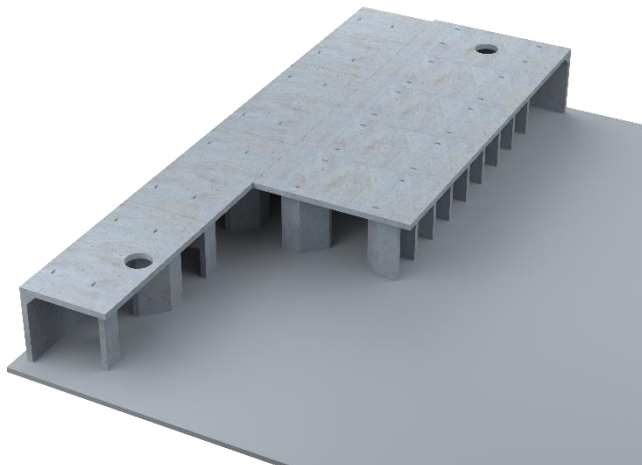

3. INSTALL SUBSEQUENT MODULES

Install subsequent modules as above, proceeding in an orderly manner moving in rows that follow a line and grade that is true to the first-placed corner module.

Modules should be placed and aligned to within $\pm 3/4"$ of each other horizontally and vertically. Modules not within $3/4"$ grade of the prior placed module should be removed and reset. The Engineer should be consulted for a course of action if module gaps cannot be made to be $3/4"$ or less.

MONO ON CONCRETE SLAB INSTALLATION

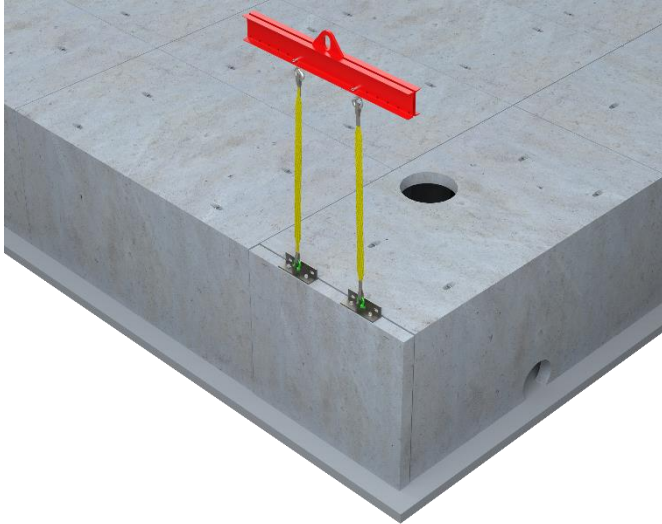

4. INSTALL WALL PANELS

Following the same lifting guidelines as above, lower a Wall Panel into position. Using the two 1" obround holes at the top as a guide, drill into the connecting edge of the butted module (4" minimum) and insert one of the supplied 5/8" wedge anchors into each drilled hole. Drive the anchors tight, then adjust the panel for fit and alignment on the bottom and sides. Once the panel is properly aligned, place the plate washers onto the wedge anchors and tighten the nuts.

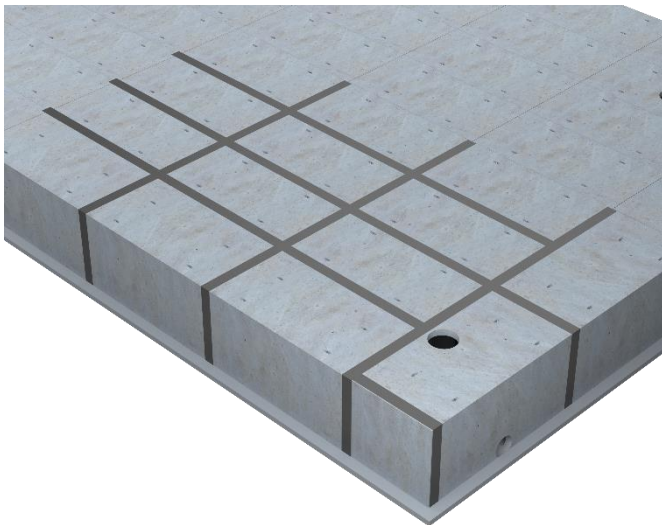

5. SEAL JOINTS

Using a polyolefin-backed exterior joint wrap conforming to ASTM C877, seal all joints between modules and between modules and wall panels on the exterior top and side surfaces. The joint wrap should span the joint by a minimum of 3.5" on either side of the joint.

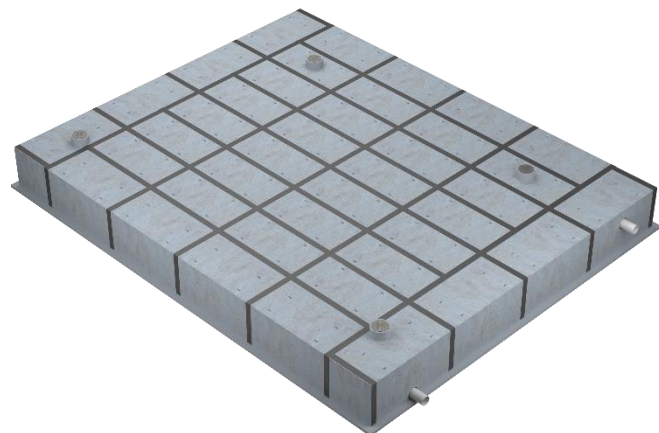

6. FINISH INSTALLATION

Install grade rings and manholes as indicated in the Plans and Shop Drawings.

Make Pipe Connections, referring to the following pages for details and requirements.

Backfill and Final Fill, referring to the following pages for details and requirements.

STACKED CONFIGURATION INSTALLATION

1. LIFT FIRST MODULE

Begin with a module in the corner of the system to ensure proper system alignment in the X and Y directions. Lift the module slowly and carefully, taking care to keep it away from other modules and equipment on site. Striking or bumping the modules should be avoided to prevent damage to the modules.

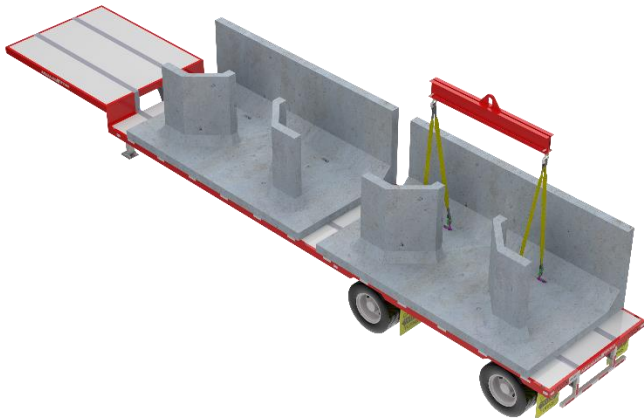

2. PLACE FIRST BASE MODULE

Lower the module to within 1 inch of the foundation, then align it to the layout lines to ensure proper placement in the X and Y directions. Ensure the module is properly aligned and squared to the lines, then slowly lower the module the remaining distance to the slab. Confirm module placement is in accordance with the Plans, recheck for squareness, and finally check for level.

Modules should be placed to within $\pm 3/4"$ of the elevations as indicated on the Plans. Any module that has had its grade disturbed after placement should be removed and reset. Any defective, damaged, or unsound module should be removed and replaced.

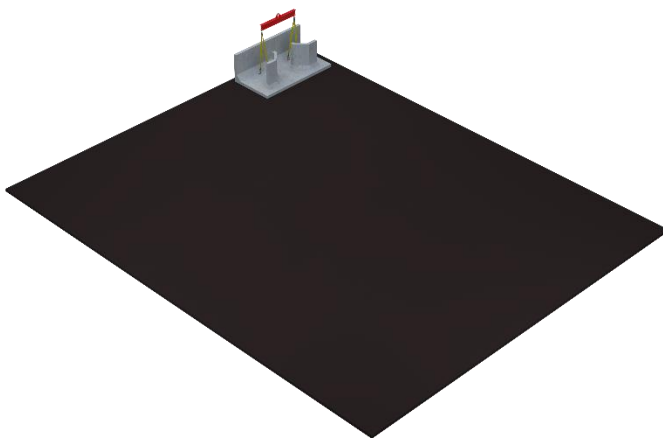

3. INSTALL SUBSEQUENT BASE MODULES

Install subsequent modules as above, proceeding in an orderly manner moving in rows that follow a line and grade that is true to the first-placed corner module.

Modules should be placed and aligned to within $\pm 3/4"$ of each other horizontally and vertically. Modules not within $3/4"$ grade of the prior placed module should be removed and reset. The Engineer should be consulted for a course of action if module gaps cannot be made to be $3/4"$ or less.

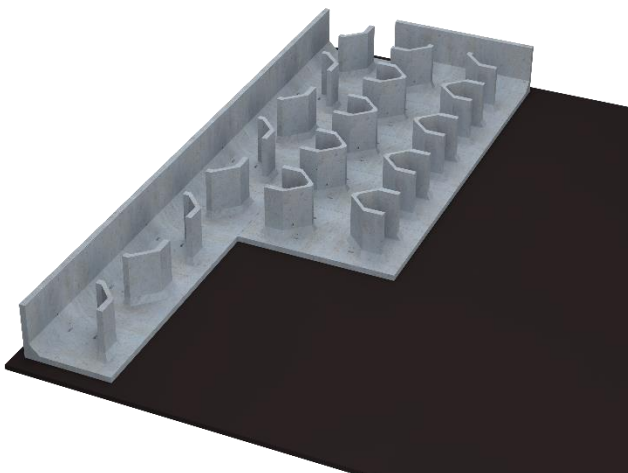

STACKED CONFIGURATION INSTALLATION



4. FINISH INSTALLING BASE MODULES

Install all base modules before installing any top modules.

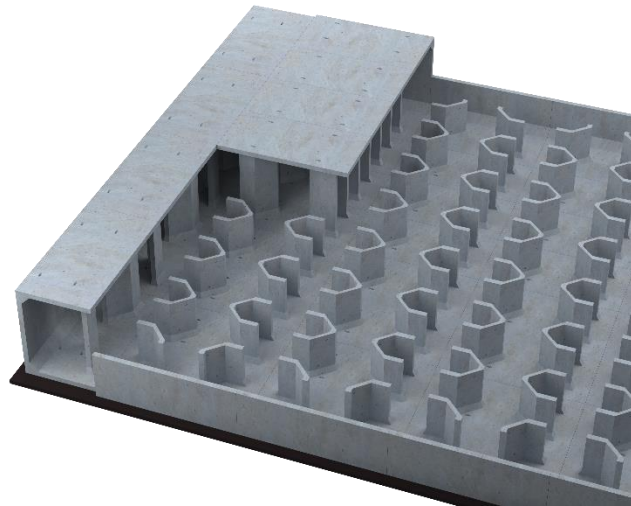

5. INSTALL TOP MODULES

Install top modules onto their matching bottom modules. Proceed in an orderly manner following rows, and ensure any modules with manhole or pipe openings are located correctly per the plans.

Install all top modules before installing wall panels.

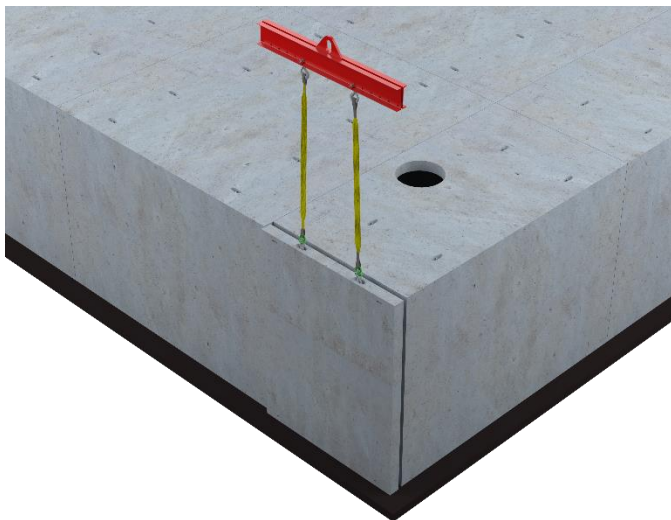

6. INSTALL WALL PANELS

Following the same lifting guidelines as above, lower a Wall Panel into position. Using the two 1" obround holes at the top and bottom as a guide, drill into the connecting edge of the butted module (4" minimum) and insert one of the supplied 5/8" wedge anchors into each drilled hole. Drive the anchors tight, then adjust the panel for fit and alignment on the bottom and sides. Once the panel is properly aligned, place the plate washers onto the wedge anchors and tighten the nuts.

STACKED CONFIGURATION INSTALLATION



7. SEAL JOINTS

Using a polyolefin-backed exterior joint wrap conforming to ASTM C877, seal all joints between modules and between modules and wall panels on the exterior top and side surfaces. The joint wrap should span the joint by a minimum of 3.5" on either side of the joint.

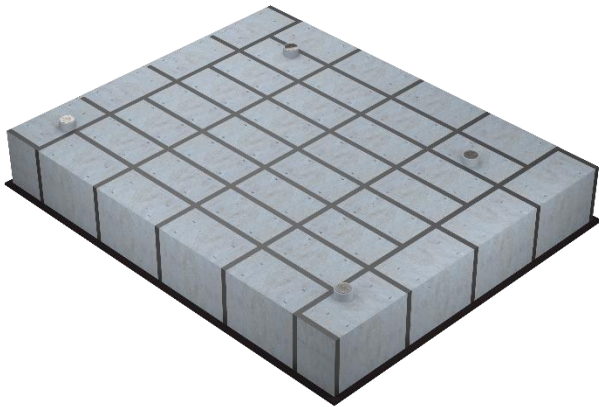

8. FINISH INSTALLATION

Install grade rings and manholes as indicated in the Plans and Shop Drawings.

Make Pipe Connections, referring to the following pages for details and requirements.

Backfill and Final Fill, referring to the following pages for details and requirements.

PIPE CONNECTIONS

Pipe connections to the UrbanPond system are dependent on the system type being installed. Pipe connections may be silt-tight or water-tight depending on the application. UrbanPond concrete components that require a pipe connection will be detailed in the Shop Drawings and on the Plans. The Contractor should confirm the locations and elevations align with the requirements on the Project Plans. In most cases, concrete components are formed with a pipe opening to accept the size and type of pipe indicated on the Plans and Shop Drawings. In some cases, the pipe connection opening may have to be cored in the field.

SILT-TIGHT

Silt-tight pipe connections can be used on infiltration systems and some detention systems. Silt-tight pipe connections consist of a grouted seal of the pipe to the concrete module or wall panel. The grouted connection should be installed per the Plans and with the pipe flush or slightly protruding. Non-shrink grout should conform to ASTM C1107.



<i>PIPE DATA</i>	<i>I.E.</i>	<i>MATERIAL</i>	<i>DIAMETER</i>
<i>INLET PIPE 1</i>	---	---	---
<i>OUTLET PIPE 1</i>	---	---	---

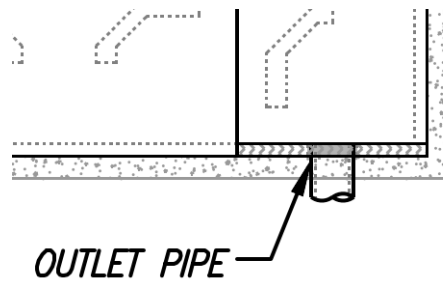

WATER-TIGHT

Water-tight pipe connections can be used on infiltration systems or detention systems. Water-tight pipe connections consist of a rubber boot that seals around the pipe and to the interior of the concrete opening in the module or wall panel. The rubber boot connection should be installed as per the details below. Pipe openings should be sized to accept pipes of the specified size(s) and material(s) and should be sealed by use of a Resilient Connector conforming to ASTM C923, C1478, or F2510.



BACKFILL AND FINAL FILL

BACKFILL

After all modules and wall panels have been installed and sealed, and after all pipe connections have been made, the system can be backfilled. Note: Pipe connections at the top of the system may be deferred until the backfilling operation has reached the level of the pipes in order to facilitate the backfilling operation.

Select material from excavation or borrow, at a moisture content that will facilitate compaction, should be placed along all sides of the system in layer depths to ensure minimum compaction density is obtained evenly throughout the backfill material. The backfill should be brought up evenly on all sides of the system. Each layer should be thoroughly compacted with mechanical tampers or rammers. Tests for density should be made as necessary to ensure conformance to the compaction requirements as Specified in the Geotechnical Report.

The backfill material for an UrbanPond infiltration system should consist of borrow that conforms to ASTM D2487 group GP or SP. These materials are typically washed granular material such as 3/4" crushed rock or washed sand.

The backfill material for an UrbanPond detention system should consist of a native material or borrow that conforms to ASTM D2487 except group OL, CH, MH, OH, and PT. Material from the excavation, provided it conforms to one of the acceptable groups, can be utilized for detention system bedding.

FINAL FILL

After backfilling has been completed to the top of the UrbanPond system and access structures have been set, the final fill material should be placed and compacted. Material for the final fill should be based on the Project Plans and Specifications and the recommendations of the Geotechnical Engineer.

Movement of construction machinery over the stormwater storage system at any stage of construction is at the Contractor's risk. Any damaged member should be removed and replaced. Any equipment used during any stage of construction should have a loading no greater than HS20 per AASHTO – Standard Specifications for Highway Bridges, 17th Edition – 2002. Permissible equipment should not be allowed to operate over top of the system with less than 12 inches of structural cover.

UrbanPond Preconstruction Checklist

Contech Field Contact and Phone: _____

Contech Plant Contact and Phone: _____

Contractor Contact and Phone: _____

Project Name: _____

Site Address: _____

Pre-con Attendees: _____

Topics to Review:

- System layout and shop drawing review
- Accessories and components supplied by Contech
- Equipment and materials needed by Contractor for installation
- Site Access and storage options
- Delivery preparation – number of loads, pieces per load, and sequencing of loads
- Offloading – rigging, lifting, handling, and safety requirements
- Bedding and backfill review – ASTM D2487 acceptable soil groups, 90% compaction, placement strategy
- Base slab preparation - **only required for mono detention projects, design by EOR
- Placement and setting of modules, which piece to start with, and pipe connections
- Spacing and alignment of modules, +/- 3/4" acceptable tolerance
- Wall panel installation and joint review

Notes: _____



CONTECH[®]

ENGINEERED SOLUTIONS
A QUIKRETE[®] COMPANY

© 2025 CONTECH ENGINEERED SOLUTIONS LLC, A QUIKRETE COMPANY

800-338-1122

WWW.CONTECHES.COM

ALL RIGHTS RESERVED. PRINTED IN THE USA.

CONTECH ENGINEERED SOLUTIONS LLC PROVIDES SITE SOLUTIONS FOR THE CIVIL ENGINEERING INDUSTRY. CONTECH'S PORTFOLIO INCLUDES BRIDGES, DRAINAGE, SANITARY SEWER, STORMWATER AND EARTH STABILIZATION PRODUCTS. FOR INFORMATION ON OTHER CONTECH DIVISION OFFERINGS, VISIT CONTECHES.COM OR CALL 800-338-1122.

SUPPORT

DRAWINGS AND SPECIFICATIONS ARE AVAILABLE AT WWW.CONTECHES.COM

UrbanPond[®] Installation Manual 01/25

NOTHING IN THIS CATALOG SHOULD BE CONSTRUED AS A WARRANTY. APPLICATIONS SUGGESTED HEREIN ARE DESCRIBED ONLY TO HELP READERS MAKE THEIR OWN EVALUATIONS AND DECISIONS, AND ARE NEITHER GUARANTEES NOR WARRANTIES OF SUITABILITY FOR ANY APPLICATION. CONTECH MAKES NO WARRANTY WHATSOEVER, EXPRESS OR IMPLIED, RELATED TO THE APPLICATIONS, MATERIALS, COATINGS, OR PRODUCTS DISCUSSED HEREIN. ALL IMPLIED WARRANTIES OF MERCHANTABILITY AND ALL IMPLIED WARRANTIES OF FITNESS FOR ANY PARTICULAR PURPOSE ARE DISCLAIMED BY CONTECH. SEE CONTECH'S CONDITIONS OF SALE (AVAILABLE AT WWW.CONTECHES.COM/COS) FOR MORE INFORMATION.