

# **Filterra Vault**

# **Owner's Manual**

(Precast Vault Configurations)



**filterra**<sup>®</sup>

Bioretention Systems

**C** **NTECH**<sup>®</sup>  
ENGINEERED SOLUTIONS

This Owner's Manual applies to all precast Filterra Configurations,  
including Filterra Bioscape Vault and Filterra HC.





## Table of Contents

Introduction .....	4
Activation Overview .....	4
Filtererra Plant Selection Overview .....	6
Warranty Overview .....	6
Routine Maintenance Guidelines.....	6
Maintenance Visit Procedure.....	9
Plant Care .....	11
Appendix 1 – Activation Package .....	12
Appendix 2 – Filtererra Tree Grate Opening Expansion Procedure.....	19



# Introduction

Thank you for your purchase of the Filterra® Bioretention System. Filterra is a specially engineered stormwater treatment system incorporating high performance biofiltration media to remove pollutants from stormwater runoff. The system’s biota (vegetation and soil microorganisms) then further breakdown and absorb captured pollutants. All components of the system work together to provide a sustainable long-term solution for treating stormwater runoff.

The Filterra system has been delivered to you with protection in place to resist intrusion of construction related sediment which can contaminate the biofiltration media and result in inadequate system performance. These protection devices are intended as a best practice and cannot fully prevent contamination. It is the purchaser’s responsibility to provide adequate measures to prevent construction related runoff from entering the Filterra system.

Included with your purchase is Activation of the Filterra system by the manufacturer as well as a 1-year warranty from delivery of the system and a final site assessment of unit condition (mulch replacement, debris removal, and pruning of vegetation) scheduled between 6 and 12 months after activation, upon request.

## Design and Installation

Each project presents different scopes for the use of Filterra systems. Information and help may be provided to the design engineer during the planning process. Correct Filterra box sizing (by rainfall region) is essential to predict pollutant removal rates for a given area. The engineer shall submit calculations for approval by the local jurisdiction. The contractor is responsible for the correct installation of Filterra units as shown in approved plans. A comprehensive installation manual is available at [www.ContechES.com](http://www.ContechES.com).

## Activation Overview

Activation of the Filterra system is a procedure completed by the manufacturer to place the system into working condition. This involves the following items:

- Removal of construction runoff protection devices.
- Planting of the system’s vegetation (provided by the purchaser).
- Placement of pretreatment mulch layer using mulch acceptable for use in Filterra systems.

Activation MUST be provided by the manufacturer to ensure proper site conditions are met for Activation, proper installation of the vegetation, and use of pretreatment mulch acceptable for use in Filterra systems. More information is available in the Filterra Activation Package.



## Minimum Requirements

The minimum requirements for Filterra Activation are as follows:

**1. The purchaser must have procured vegetation meeting the requirements outlined in the Filterra Activation Package.**

2. The site landscaping must be fully stabilized, i.e. full landscaping installed and some grass cover (not just straw and seed) is required to reduce sediment transport. Construction debris and materials should be removed from surrounding area.



3. Final paving must be completed. Final paving ensures that paving materials will not enter and contaminate the Filterra system during the paving process, and that the plant will receive runoff from the drainage area, assisting with plant survival for the Filterra system.



4. Filterra throat opening should be at least 4" in order to ensure adequate capacity for inflow and debris.

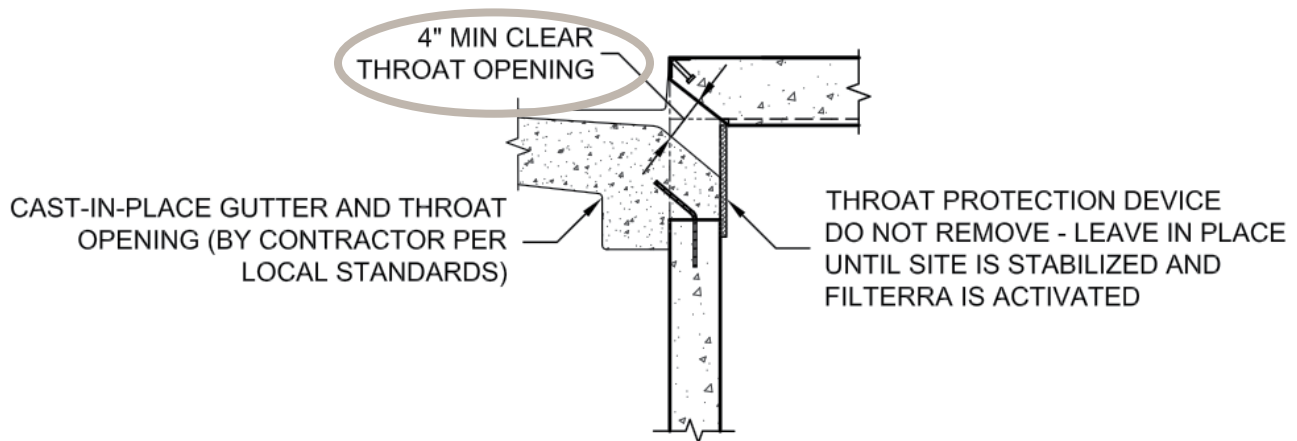

The Filterra Activation Package is available on the Contech website ([www.ContechES.com/filterra](http://www.ContechES.com/filterra)) and ensures that the proper conditions are met for Contech to perform the Activation service. Vegetation meeting Contech's requirements must be provided at time of Activation. If the site does not meet the conditions required for Activation, or acceptable vegetation is not provided by the purchaser at time of Activation, a charge of \$1,500 will be invoiced to the purchaser.

## Filterra Plant Selection Overview

A Plant List is available on the Contech website highlighting recommended plants for Filterra systems in your area. Keep in mind that plants are subject to availability due to seasonality and required minimum size for the Filterra system. Plants installed in the Filterra system are container plants (max 15 gallon) from nursery stock and will be immature in height and spread at Activation.

It is the responsibility of the owner to provide adequate irrigation when necessary to the plant of the Filterra system.

More information is available in the Filterra Activation Package.

## Warranty Overview

Refer to the Contech Engineered Solutions LLC Stormwater Treatment System LIMITED WARRANTY for further information. The following conditions may void the Filterra system's warranty and waive the manufacturer provided Activation and Final Site Assessment services:

- Unauthorized activation or performance of any of the items listed in the activation overview
- Any tampering, modifications or damage to the Filterra system or runoff protection devices
- Removal of any Filterra system components
- Failure to prevent construction related runoff from entering the Filterra system
- Failure to properly store and protect any Filterra components (including media and underdrain stone) that may be shipped separately from the vault

## Final Site Assessment

With proper routine maintenance, the biofiltration media within the Filterra system should last as long as traditional bioretention media. A final site assessment is included by the manufacturer, upon request, on all Filterra systems between 6 and 12 months after activation. This includes a final assessment of unit condition, debris removal, mulch replacement, and pruning of vegetation. More information is provided in the Operations and Maintenance Guidelines. Some Filterra systems also contain pretreatment or outlet bays. Depending on site pollutant loading, these bays may require periodic removal of debris, however this is not included in the final site assessment, and would likely not be required within the first year of operation.

These services, as well as routine maintenance outside of the included first year, can be provided by certified maintenance providers listed on the Contech website. Training can also be provided to other stormwater maintenance or landscape providers.



## Why Maintain?

All stormwater treatment systems require maintenance for effective operation. This necessity is often incorporated in your property's permitting process as a legally binding BMP maintenance agreement. Other reasons to maintain are:

- Avoiding legal challenges from your jurisdiction's maintenance enforcement program.
- Prolonging the expected lifespan of your Filterra media.
- Avoiding more costly media replacement.
- Helping reduce pollutant loads leaving your property.

Simple maintenance of the Filterra is required to continue effective pollutant removal from stormwater runoff before discharge into downstream waters. This procedure will also extend the longevity of the living biofilter system. The unit will recycle and accumulate pollutants within the biomass, but is also subjected to other materials entering the inlet. This may include trash, silt and leaves etc. which will be contained above the mulch layer. Too much silt may inhibit the Filterra's flow rate, which is the reason for site stabilization before activation. Regular replacement of the mulch stops accumulation of such sediment.

## When to Maintain?

Maintenance visits are scheduled seasonally; the spring visit aims to clean up after winter loads including salts and sands while the fall visit helps the system by removing excessive leaf litter.

It has been found that in regions which receive between 30-50 inches of annual rainfall, (2) two visits are generally required; in regions with less rainfall often only (1) one visit per annum is sufficient. Varying land uses can affect maintenance frequency. Contributing drainage areas which are subject to new development wherein the recommended erosion and sediment control measures have not been implemented may require additional maintenance visits.

Some sites may be subjected to extreme sediment or trash loads, requiring more frequent maintenance visits. This is the reason for detailed notes of maintenance actions per unit, helping the Supplier and Owner predict future maintenance frequencies, reflecting individual site conditions.

Owners must promptly notify the maintenance provider of any damage to the plant(s), which constitute(s) an integral part of the bioretention technology.



## Exclusion of Services

Clean up due to major contamination such as oils, chemicals, toxic spills, etc. will result in additional costs and are not included as part of the final site assessment. Should a major contamination event occur the Owner must block off the outlet pipe of the Filterra (where the cleaned runoff drains to, such as drop inlet) and block off the throat of the Filterra. The Supplier should be informed immediately.

## Maintenance Visit Summary

Each maintenance visit consists of the following simple tasks (detailed instructions below).

1. Inspection of Filterra and surrounding area
2. Removal of tree grate and erosion control stones
3. Removal of debris, trash and mulch
4. Mulch replacement
5. Plant health evaluation and pruning or replacement as necessary
6. Clean area around Filterra
7. Complete paperwork

## Maintenance Tools, Safety Equipment and Supplies

Ideal tools include: camera, bucket, shovel, broom, pruners, hoe/rake, and tape measure. Appropriate Personal Protective Equipment (PPE) should be used in accordance with local or company procedures. This may include impervious gloves where the type of trash is unknown, high visibility clothing and barricades when working in close proximity to traffic and also safety hats and shoes. A T-Bar or crowbar should be used for moving the tree grates (up to 170 lbs ea.). Most visits require minor trash removal and a full replacement of mulch. See below for actual number of bagged mulch that is required in each media bay size. Mulch should be a double shredded, hardwood variety. Some visits may require additional Filterra engineered soil media available from the Supplier.

Box Length	Box Width	Filter Surface Area (ft <sup>2</sup> )	Volume at 3" (ft <sup>3</sup> )	# of 2 ft <sup>3</sup> Mulch Bags
4	4	16	4	2
6	4	24	6	3
8	4	32	8	4
6	6	36	9	5
8	6	48	12	6
10	6	60	15	8
12	6	72	18	9
13	7	91	23	12

Other sizes not listed - 1 bag per 8 ft<sup>2</sup> of media.



# Maintenance Visit Procedure

Keep sufficient documentation of maintenance actions to predict location specific maintenance frequencies and needs. An example Maintenance Report is included in this manual.



## 1. Inspection of Filterra and surrounding area

- Record individual unit before maintenance with photograph (numbered). Record on Maintenance Report (see example in this document) the following:

Record on Maintenance Report the following:

Standing Water	yes		no
Damage to Box Structure	yes		no
Damage to Grate	yes		no
Is Bypass Clear	yes		no

If yes answered to any of these observations, record with close-up photograph (numbered).



## 2. Removal of tree grate and erosion control stones

- Remove cast iron grates for access into Filterra box.
- Dig out silt (if any) and mulch and remove trash & foreign items.

## 3. Removal of debris, trash and mulch

Record on Maintenance Report the following:

Silt/Clay	yes		no
Cups/ Bags	yes		no
Leaves	yes		no
Buckets Removed	_____		



- After removal of mulch and debris, measure distance from the top of the Filterra engineered media soil to the top of the top slab. Compare the measured distance to the distance shown on the approved Contract Drawings for the system. Add Filterra media (not top soil or other) to bring media up as needed to distance indicated on drawings.

Record on Maintenance Report the following:

Distance to Top of Top Slab (inches)	_____
Inches of Media Added	_____



#### 4. Mulch replacement

- Add double shredded mulch evenly across the entire unit to a depth of 3".
- Refer to Filterra Mulch Specifications for information on acceptable sources.
- Ensure correct repositioning of erosion control stones by the Filterra inlet to allow for entry of trash during a storm event.
- Replace Filterra grates correctly using appropriate lifting or moving tools, taking care not to damage the plant.



#### 5. Plant health evaluation and pruning or replacement as necessary

- Examine the plant's health and replace if necessary.
- Prune as necessary to encourage growth in the correct directions

Record on Maintenance Report the following:

Height above Grate	_____	(ft)
Width at Widest Point	_____	(ft)
Health	healthy   unhealthy	
Damage to Plant	yes   no	
Plant Replaced	yes   no	



#### 6. Clean area around Filterra

- Clean area around unit and remove all refuse to be disposed of appropriately.



#### 7. Complete paperwork

- Deliver Maintenance Report.
- Some jurisdictions may require submission of maintenance reports in accordance with approvals. It is the responsibility of the Owner to comply with local regulations.

# Plant Care for Filterra® Systems

After Activation, the Contractor is responsible for proper care of the vegetation until the site is handed over to the Owner. After that, it is the Site Owner's responsibility to care for the vegetation. Contech recommends the following care for the plants:

1. To prevent transplant shock (especially if planting takes place in the hot season), it may be necessary to prune some of the foliage to compensate for reduced root uptake capacity. This is accomplished by pruning away some of the smaller secondary branches or a main scaffold branch if there are too many. Too much foliage relative to the root ball can dehydrate and damage the plant.
2. Plant staking may be required.
3. With all trees/shrubs, remove dead, diseased, crossed/rubbing, sharply crotched branches or branches growing excessively long or in wrong direction compared to majority of branches.
4. Contech recommends irrigation of the Filterra® Vegetation. The following guidance will help to ensure the vegetation is properly irrigated.

## Irrigation Recommendations:

- Each Filterra® system must receive adequate irrigation to ensure survival of the living system during periods of drier weather.
- Irrigation sources include rainfall runoff from downspouts and/or gutter flow, applied water through the tree grate or in some cases from an irrigation system with emitters installed during construction.
- At Activation: Apply about one (cool climates) to two (warm climates) gallons of water per inch of trunk diameter over the root ball.
- During Establishment: In common with all plants, each Filterra® plant will require more frequent watering during the establishment period. One inch of applied water per week for the first three months is recommended for cooler climates (2 to 3 inches for warmer climates). If the system is receiving rainfall runoff from the drainage area, then irrigation may not be needed. Inspection of the soil moisture content can be evaluated by gently brushing aside the mulch layer and feeling the soil. Be sure to replace the mulch when the assessment is complete. Irrigate as needed\*\*.
- Established Plants: Established plants have fully developed root systems and can access the entire water column in the media. Therefore irrigation is less frequent but requires more applied water when performed. For a mature system assume 3.5 inches of available water within the media matrix. Irrigation demand can be estimated as 1" of irrigation demand per week. Therefore if dry periods exceed 3 weeks, irrigation may be required.

*\*\* Five gallons per square yard approximates 1 inch of water. Therefore for a 6' x 6 foot Filterra® approximately 20-60 gallons of applied water is needed. To ensure even distribution of water it needs to be evenly sprinkled over the entire surface of the filter bed, with special attention to make sure the root ball is completely wetted. NOTE: if needed, measure the time it takes to fill a five gallon bucket to estimate the applied water flow rate. Then calculate the time needed to irrigate the Filterra®, For example if the flow rate of the sprinkler is 5 gallons/minute then it would take 12 minutes to irrigate a 6'x6' filter.*

## Plant Replacement:

In some cases, plants will require replacement. Please follow the procedures below to ensure a properly functioning Filterra® system.

1. Remove the existing plant, and leave as much of the Filterra® media in place as possible.
2. Select a replacement per the Filterra® Activation Package.
3. Prior to removing the plant from the container, ensure the soil moisture is sufficient to maintain the integrity of the root ball. If needed, pre-wet the container plant.
4. Cut away any roots which are growing out of the container drain holes.
5. Plant(s) should be carefully removed from the pot by gently pounding on the sides of the container with the fist to loosen root ball. Then carefully slide out. Do not lift plant(s) by trunk as this can break roots and cause soil to fall off. Extract the root ball in a horizontal position and support it to prevent it from breaking apart. Alternatively, the pot can be cut away to minimize root ball disturbance.
6. Excavate a hole with a diameter 4" greater than the root ball, gently place the plant(s).
7. Plant the tree/shrub/grass with the top of the root ball 1" above surrounding media to allow for settling.
8. All plants should have the main stem centered in the tree grate (where applicable) upon completion of installation.
9. Reinstall or add mulch to a depth of 3" per Contech's mulch specifications for Filterra® systems.

# Maintenance Checklist

Drainage System Failure	Problem	Conditions to Check	Condition that Should Exist	Actions
Inlet	Excessive sediment or trash accumulation.	Accumulated sediments or trash impair free flow of water into Filterra.	Inlet should be free of obstructions allowing free distributed flow of water into Filterra.	Sediments and/or trash should be removed.
Mulch Cover	Trash and floatable debris accumulation.	Excessive trash and/or debris accumulation.	Minimal trash or other debris on mulch cover.	Trash and debris should be removed and mulch cover raked level. Ensure bark nugget mulch is not used.
Mulch Cover	"Ponding" of water on mulch cover.	"Ponding" in unit could be indicative of clogging due to excessive fine sediment accumulation or spill of petroleum oils.	Stormwater should drain freely and evenly through mulch cover.	Recommend contact manufacturer and replace mulch as a minimum.
Vegetation	Plants not growing or in poor condition.	Soil/mulch too wet, evidence of spill. Incorrect plant selection. Pest infestation. Vandalism to plants.	Plants should be healthy and pest free.	Contact manufacturer for advice.
Vegetation	Plant growth excessive.	Plants should be appropriate to the species and location of Filterra.		Trim/prune plants in accordance with typical landscaping and safety needs.
Structure	Structure has visible cracks.	Cracks wider than 1/2 inch or evidence of soil particles entering the structure through the cracks.		Vault should be repaired.

Maintenance is ideally to be performed twice annually.

## Filterra Inspection & Maintenance Log

Filterra System Size/Model: \_\_\_\_\_ Location: \_\_\_\_\_

Date	Mulch & Debris Removed	Depth of Mulch Added	Mulch Brand	Height of Vegetation Above Grate	Vegetation Species	Issues with System	Comments
1/1/17	5 – 5 gal Buckets	3"	Lowe's Premium Brown Mulch	4'	Galaxy Magnolia	- Standing water in downstream structure	- Removed blockage in downstream structure

# Appendix 1 – Filterra® Vault Activation Package

## FILTERRA® VAULT ACTIVATION PACKAGE



The Filterra system will be (or has been) delivered to you with protection in place to resist intrusion of construction related sediment which can contaminate the biofiltration media and result in inadequate system performance. These protection devices are intended as a best practice and cannot fully prevent contamination. It is the purchaser's responsibility to provide adequate measures to prevent construction related runoff from entering the Filterra system.

Included with your purchase is Activation of the Filterra system by the manufacturer as well as a 1-year warranty from delivery of the system and a Final Site Assessment (assessment of unit condition, mulch replacement, debris removal, and pruning of vegetation) scheduled between 6 months and 1 year after Activation, upon request.

Activation of the Filterra system is a procedure completed by the manufacturer to place the system into working condition. This involves the following items:

- Removal of construction runoff protection devices
- Planting of the system's vegetation (provided by the purchaser)
- Placement of pretreatment mulch layer using mulch acceptable for use in Filterra systems.

Activation MUST be provided by the manufacturer to ensure proper site conditions are met for Activation, proper installation of the vegetation, and use of pretreatment mulch acceptable for use in Filterra systems. The purchaser should request Activation from Contech after the site is stabilized, but prior to turning over the site to the owner. Please allow 1-2 weeks to schedule Activation.

The purchaser must ensure that the site is acceptable for Filterra Activation. A checklist (included as page 3 of this document) must be completed and submitted to the Contech Activation Coordinator. The minimum 4 requirements for Filterra Activation are as follows:

1. The purchaser must have sourced vegetation meeting the requirements outlined in "Plant Selection for Filterra Systems" starting on page 4 of this document.



*\* UNPREPARED SITE FEE NOTE: A charge of \$1500.00 will be invoiced for each activation visit requested by customer where Contech determines that the site does not meet the conditions required for Activation AND/OR acceptable plants are not provided by the contractor. ONLY Contech authorized representatives can perform Activation of Filterra systems; unauthorized activations will void the system warranty and waive manufacturer supplied activation and final inspection.*



2. The site landscaping must be fully stabilized, i.e. full landscaping installed and some grass cover (not just straw and seed) is required to reduce sediment transport. Construction debris and materials should be removed from surrounding area.



3. Final paving must be completed. Final paving ensures that paving materials will not enter and contaminate the Filterra system during the paving process, and that the plant will receive runoff from the drainage area, assisting with plant survival for the Filterra system.



4. Where curb inlets are included as part of the Filterra system, Filterra throat opening should be at least 4" clear in order to ensure adequate capacity for inflow and debris.

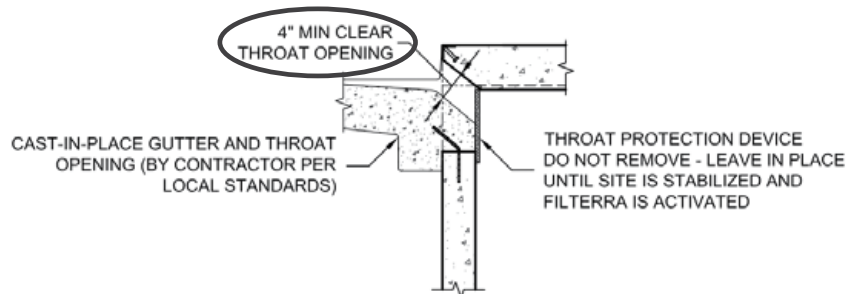

\* UNPREPARED SITE FEE NOTE: A charge of \$1500.00 will be invoiced for each activation visit requested by customer where Contech determines that the site does not meet the conditions required for Activation AND/OR acceptable plants are not provided by the contractor. ONLY Contech authorized representatives can perform Activation of Filterra systems; unauthorized activations will void the system warranty and waive manufacturer supplied activation and final inspection.



# Filterra® Vault Activation Checklist



Project Name: \_\_\_\_\_ Company: \_\_\_\_\_

Site Contact Name: \_\_\_\_\_ Site Contact Phone/Email: \_\_\_\_\_

Site Owner/End User Name: \_\_\_\_\_ Site Owner/End User Phone/Email: \_\_\_\_\_

Preferred Activation Date: \_\_\_\_\_ (provide 2 weeks minimum from date this form is submitted)

Site Designation	Top Opening Type	Final Pavement Complete	Landscaping Complete / Grass Emerging	Construction materials / Piles / Debris Removed	Throat Opening Measures 4" Min. Height (where applicable)	Vegetation Sourced by Contractor
	<input type="checkbox"/> Tree Grate <input type="checkbox"/> Full Grate (No tree opening) <input type="checkbox"/> Bioscape Vault (Open Planter)	<input type="checkbox"/> Verified	<input type="checkbox"/> Verified	<input type="checkbox"/> Verified	<input type="checkbox"/> Verified	<input type="checkbox"/> Species on FT Plant List <input type="checkbox"/> Container Grown (15 gal. max) <input type="checkbox"/> 4' Tall Min. (Tree grate units only) _____ Qty provided
	<input type="checkbox"/> Tree Grate <input type="checkbox"/> Full Grate (No tree opening) <input type="checkbox"/> Bioscape Vault (Open Planter)	<input type="checkbox"/> Verified	<input type="checkbox"/> Verified	<input type="checkbox"/> Verified	<input type="checkbox"/> Verified	<input type="checkbox"/> Species on FT Plant List <input type="checkbox"/> Container Grown (15 gal. max) <input type="checkbox"/> 4' Tall Min. (Tree grate units only) _____ Qty provided
	<input type="checkbox"/> Tree Grate <input type="checkbox"/> Full Grate (No tree opening) <input type="checkbox"/> Bioscape Vault (Open Planter)	<input type="checkbox"/> Verified	<input type="checkbox"/> Verified	<input type="checkbox"/> Verified	<input type="checkbox"/> Verified	<input type="checkbox"/> Species on FT Plant List <input type="checkbox"/> Container Grown (15 gal. max) <input type="checkbox"/> 4' Tall Min. (Tree grate units only) _____ Qty provided
	<input type="checkbox"/> Tree Grate <input type="checkbox"/> Full Grate (No tree opening) <input type="checkbox"/> Bioscape Vault (Open Planter)	<input type="checkbox"/> Verified	<input type="checkbox"/> Verified	<input type="checkbox"/> Verified	<input type="checkbox"/> Verified	<input type="checkbox"/> Species on FT Plant List <input type="checkbox"/> Container Grown (15 gal. max) <input type="checkbox"/> 4' Tall Min. (Tree grate units only) _____ Qty provided

Attach additional sheets as necessary.

NOTE: A charge of \$1500.00 will be invoiced for each activation visit requested by customer where Contech determines that the site does not meet the conditions required for activation AND/OR acceptable plants are not provided by the contractor. ONLY Contech authorized representatives can perform activation of Filterra systems; unauthorized activations will void the system warranty and waive manufacturer supplied activation and final inspection.

\_\_\_\_\_  
Signature Date

\* UNPREPARED SITE FEE NOTE: A charge of \$1500.00 will be invoiced for each activation visit requested by customer where Contech determines that the site does not meet the conditions required for Activation AND/OR acceptable plants are not provided by the contractor. ONLY Contech authorized representatives can perform Activation of Filterra systems; unauthorized activations will void the system warranty and waive manufacturer supplied activation and final inspection.



# Planting Selection for Filterra® Vault Systems

All Filterra systems require vegetation for proper long-term performance. As indicated in the Activation Package, the Contractor is responsible for sourcing the proper vegetation prior to Activation. Contech or a Contech representative will install the vegetation during the Activation process.

Contractors should identify the Top Opening style for each Filterra requiring Activation on the Activation Checklist. Contech offers three types, which are detailed on page 5 of this document:

- Vault with Tree Grate
- Vault with Full Grate
- Bioscape / Open Planter

Contractors must ensure the vegetation meets the following 4 requirements:

1. Select plant(s) as specified in the engineering plans and specifications AND that are listed on Contech's Configuration Specific Plant Lists\*\*.
2. All plants MUST be container-grown in nursery containers no larger than 15 gallons. Crated and/or Ball/Burlap plants are NOT permitted.
3. For Vaults with Tree Grates, plant height must be 4' Minimum, from soil surface to top of plant.
4. Provide plant quantities per the following guidance:
  - Vault with Tree Grate – 1 per Tree Grate
  - Vault with Full Grate – 4-5 Small or Extra Small Grasses per Full Grate
  - Bioscape – Quantities should be selected based on plant palette options found starting on page 6 of this document.



If Contech or Contech's representative shows up for Activation and any of the 4 requirements above are not met, Activation cannot be performed and the Contractor will be billed a \$1,500 Unprepared Site fee\*.

Some additional vegetation recommendations for the best possible Activation and Installation are as follows:

- Select plant(s) with full root development but not to the point where root bound.
- For Filterra systems with a Tree Grate, select plants with taller trunks. Lower branches can be pruned away provided there are sufficient branches above the grate for tree or shrub development.
- For Filterra systems with a Tree Grate, plant(s) should have a single trunk at installation.
- Plant species shall not have a mature height greater than 30 feet.

\*\* In some cases, Contech may consider alternate plant species as approved by the Product Manager. Please list the plant name in the space below and submit this sheet to your Contech Activation Coordinator. If the plant species is approved, either the Product Manager or the Activation Coordinator will sign the form and return to you for inclusion with your Activation Checklist.

Requested Plant Species: \_\_\_\_\_ Approved: \_\_\_\_\_

Date: \_\_\_\_\_

\* UNPREPARED SITE FEE NOTE: A charge of \$1500.00 will be invoiced for each activation visit requested by customer where Contech determines that the site does not meet the conditions required for Activation AND/OR acceptable plants are not provided by the contractor. ONLY Contech authorized representatives can perform Activation of Filterra systems; unauthorized activations will void the system warranty and waive manufacturer supplied activation and final inspection.





# Filterra® Top Opening Examples

## Filterra® Vault with Tree Grate

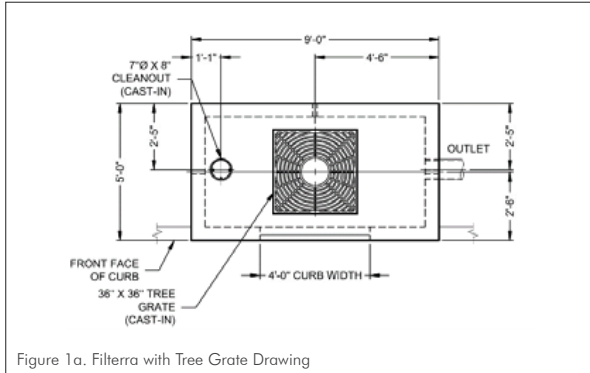

Figure 1a. Filterra with Tree Grate Drawing



Figure 1b. Filterra with Tree Grate Photo (not yet planted)

## Filterra® Vault with Full Grate

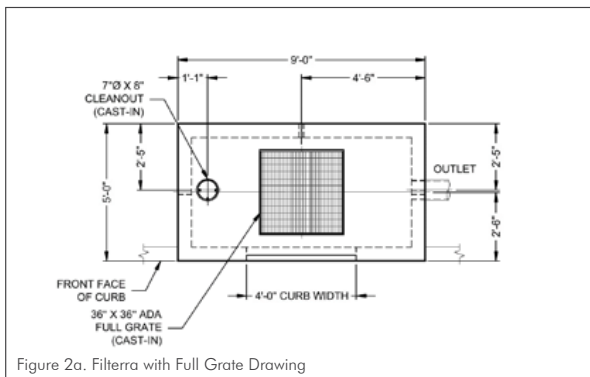

Figure 2a. Filterra with Full Grate Drawing



Figure 2b. Filterra with Full Grate Photo

## Filterra® Bioscape Vault

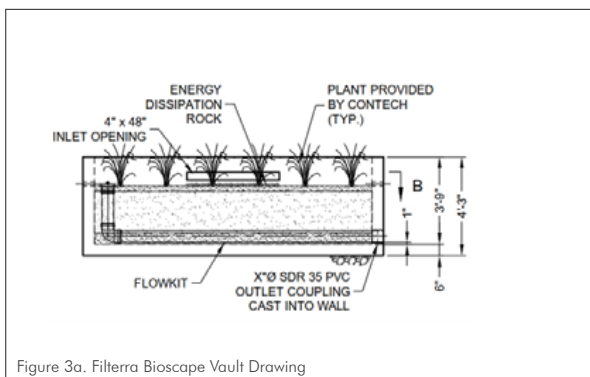

Figure 3a. Filterra Bioscape Vault Drawing







Figure 3b. Filterra Bioscape Vault Photo

\* UNPREPARED SITE FEE NOTE: A charge of \$1500.00 will be invoiced for each activation visit requested by customer where Contech determines that the site does not meet the conditions required for Activation AND/OR acceptable plants are not provided by the contractor. ONLY Contech authorized representatives can perform Activation of Filterra systems; unauthorized activations will void the system warranty and waive manufacturer supplied activation and final inspection.



# Filterra® Bioscape Vault Plant Palettes

**KEY:** (refer to plant lists for species sizing)

	<b>A. EXTRA SMALL GRASS</b>
	<ul style="list-style-type: none"> <li>• Up to 2' mature spread</li> <li>• 1-2 gallon typical (1 gal. minimum)</li> </ul>
	<b>B. SMALL GRASS/SHRUB</b>
	<ul style="list-style-type: none"> <li>• 2'-4' mature spread</li> <li>• 1-7 gallon typical</li> </ul>
	<b>C. MEDIUM SHRUB</b>
	<ul style="list-style-type: none"> <li>• 4'-6' mature spread</li> <li>• 1-7 gallon typical</li> </ul>
	<b>D. LARGE SHRUB OR EXTRA LARGE SHRUB OR TREE</b>
	<ul style="list-style-type: none"> <li>• 6' mature spread and greater, 30' max. mature height</li> <li>• Up to 15 gallon maximum</li> </ul>

**NOTE:** For larger vaults and in-ground Filterra Bioscape systems, palettes can be scaled (i.e. Qty 6 of the 22x8 Palette can be used for a 1056 sf Filterra Bioscape).

**MIX & MATCH SUBSTITUTION OPTIONS:**

- 1 Large Shrub or Extra Large Shrub or Tree
  - 2 Medium Shrubs
  - 4 Small Grass/SHrubs
  - 12 Extra Small Grasses
- 1 Medium Shrub
  - 2 Small Grass/SHrubs
  - 6 Extra Small Grasses
- 1 Small Grass/SHrub
  - 3 Extra Small Grasses

4x4 Media Bay



4x6/6x4 Media Bay



4x8/8x4 & 4.5x7.83/7.83x4.5 Media Bay



6x6 Media Bay

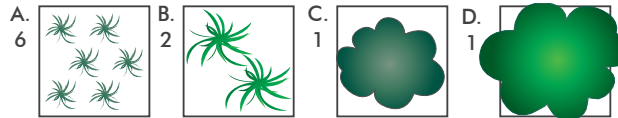

6x8/8x6 Media Bay

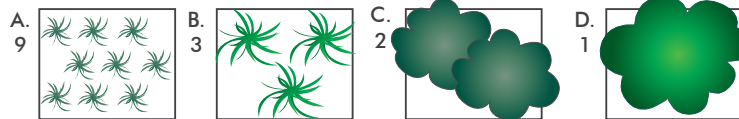

6x10/10x6 & 8x8 Media Bay

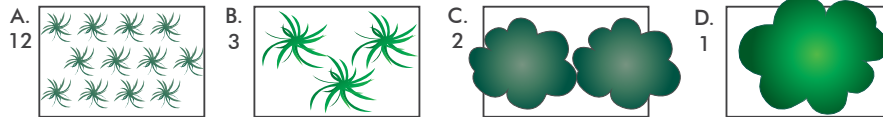

6x12/12x6 Media Bay

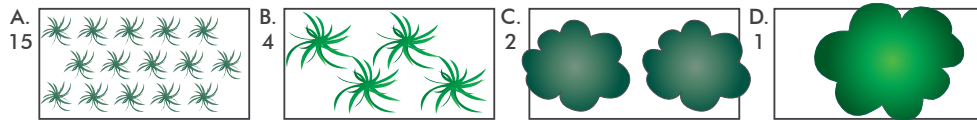

7x13/13x7/12x8 & 14x8 Media Bay

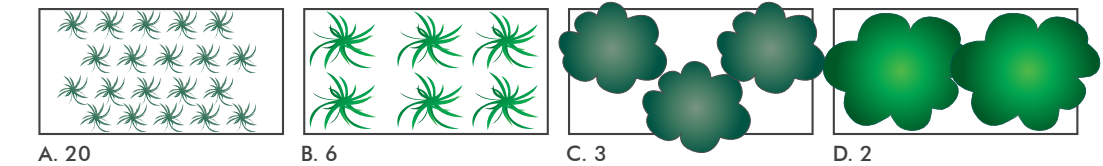

\* UNPREPARED SITE FEE NOTE: A charge of \$1500.00 will be invoiced for each activation visit requested by customer where Contech determines that the site does not meet the conditions required for Activation AND/OR acceptable plants are not provided by the contractor. ONLY Contech authorized representatives can perform Activation of Filterra systems; unauthorized activations will void the system warranty and waive manufacturer supplied activation and final inspection.



16x8 & 15x9  
Media Bay

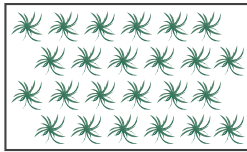

A. 24

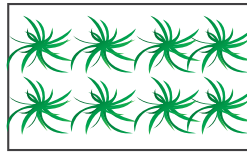

B. 8

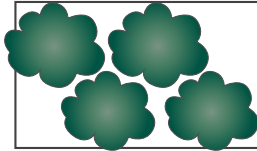

C. 4

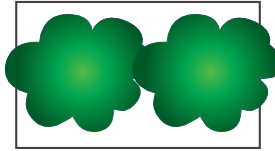

D. 2

18x8 Media Bay

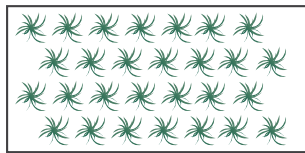

A. 28

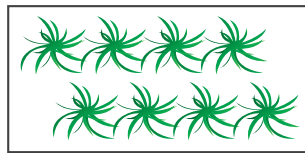

B. 8

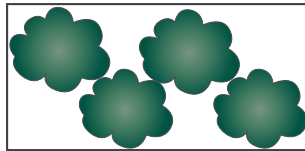

C. 4

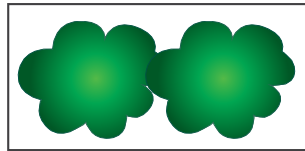

D. 2

20x8 Media Bay

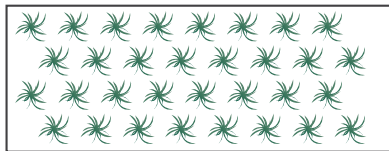

A. 32

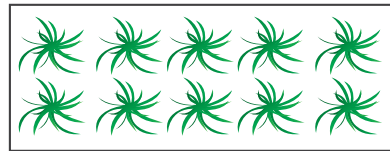

B. 10

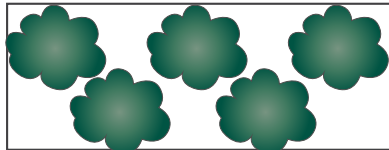

C. 5

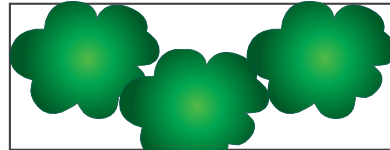

D. 3

22x8 Media Bay

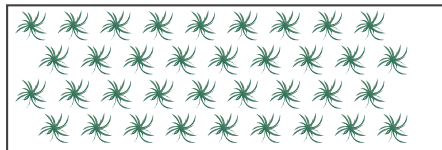

A. 36

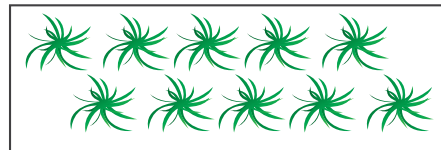

B. 10

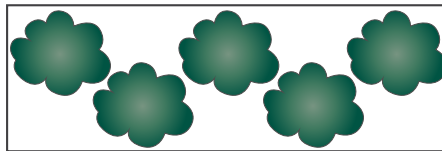

C. 5

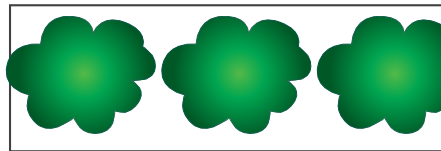

D. 3

\* UNPREPARED SITE FEE NOTE: A charge of \$1500.00 will be invoiced for each activation visit requested by customer where Contech determines that the site does not meet the conditions required for Activation AND/OR acceptable plants are not provided by the contractor. ONLY Contech authorized representatives can perform Activation of Filterra systems; unauthorized activations will void the system warranty and waive manufacturer supplied activation and final inspection.



## Appendix 2 – Filterra® Tree Grate Opening Expansion Procedure

The standard grates used on all Filterra configurations that employ Tree Grates are fabricated with a 6" opening that is designed with a breakaway section that can be removed, allowing the grate opening to be expanded to 12" as the tree matures and the trunk widens.

The following tools are required to expand the opening:

- Mini sledgehammer (3 lb. or greater)
- Safety Glasses / Goggles

The following guidelines should be followed to properly expand the tree opening from 6" to 12":

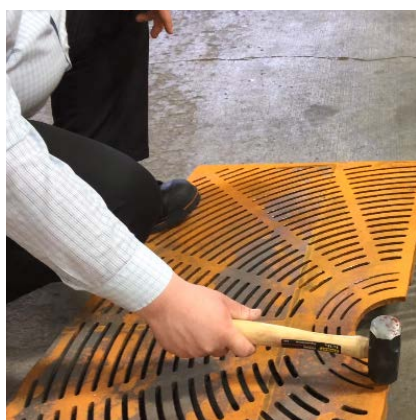

1. Remove the grate from the Filterra frame, place it flat on a hard surface, and support the grate by stepping on the edge or using other weighted items such as a few mulch bags if this is being done during a Filterra maintenance event. Put on safety glasses/goggles. Align the mini sledgehammer as shown in the figure to the left. The head of the sledgehammer should be aimed just inside the wide cast iron bar between the larger grate section and the breakaway section.

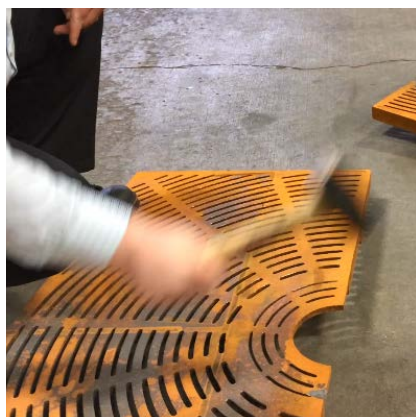

2. Repeatedly hit the grate at this spot with the mini sledgehammer.



3. After several hits, the breakaway section should snap cleanly off of the larger grate section. Reinstall the grate into the Filterra grate frame. Recycle or dispose of the breakaway section per local guidelines.









9100 Centre Pointe Drive, Suite 400  
West Chester, OH 45069  
info@conteches.com | 800-338-1122  
www.ContechES.com

© 2023 Contech Engineered Solutions LLC, a QUIKRETE Company

ALL RIGHTS RESERVED. PRINTED IN THE USA.

NOTHING IN THIS CATALOG SHOULD BE CONSTRUED AS A WARRANTY. APPLICATIONS SUGGESTED HEREIN ARE DESCRIBED ONLY TO HELP READERS MAKE THEIR OWN EVALUATIONS AND DECISIONS, AND ARE NEITHER GUARANTEES NOR WARRANTIES OF SUITABILITY FOR ANY APPLICATION. CONTECH MAKES NO WARRANTY WHATSOEVER, EXPRESS OR IMPLIED, RELATED TO THE APPLICATIONS, MATERIALS, COATINGS, OR PRODUCTS DISCUSSED HEREIN. ALL IMPLIED WARRANTIES OF MERCHANTABILITY AND ALL IMPLIED WARRANTIES OF FITNESS FOR ANY PARTICULAR PURPOSE ARE DISCLAIMED BY CONTECH. SEE CONTECH'S CONDITIONS OF SALE (AVAILABLE AT [WWW.CONTECHES.COM/COS](http://WWW.CONTECHES.COM/COS)) FOR MORE INFORMATION.