

Structural Plate Design Guide

8th Edition



MULTI-PLATE[®]

Aluminum Structural Plate

Aluminum Box Culvert

SUPER-SPAN[™]

BridgeCor[®]

Steel EXPRESS[®] Foundations

Steel and Aluminum Structural Plate Design Guide Table of Contents

This design guide is provided by Contech Engineered Solutions to assist designers with most applications and design aspects of MULTI-PLATE®, Aluminum Structural Plate (ALSP), Aluminum Box Culverts (ALBC), SUPER-SPAN™, SUPER-PLATE®, BridgeCor®, and Steel EXPRESS®. To support the designer, this written guide along with the provided standard details can be used to assist in the preparation of the project plans and specifications. For additional information, contact your local Contech representative or call 800-338-1122 to find a Contech representative near you.

Typical Design Steps

Selection of Structure Shape	5
Designing for Service Life	7
Structural Plate Design	13
MULTI-PLATE and ALSP	13
ALBC	17
SUPER-SPAN and SUPER-PLATE	18
BridgeCor	19
Minimum Cover over Plate Structures	19
Structure End Treatments	21
Material Design and Installation Specs	27

MULTI-PLATE®

Product Overview	28
Bolts and Nuts	30
Round	30
Vertical Ellipse	32
Pipe Arch	34
Single Radius Arch	37
Horizontal Ellipse	40
Underpass	42
Project Specifications	44

Aluminum Structural Plate

Product Overview	46
Bolts and Nuts	48
Handling Weights & Plate Make-Up	50
Height of Cover Table Instructions	52
Round	52
Ellipse	53
Pipe Arch	54
Single Radius Arch	56
Underpass	58
Project Specifications	60

Aluminum Box Culvert

Product Overview	62
HL-93	64
H-20/HS-20	66
H-25/HS-25	67
Aluminum Box Culverts Plate Make-Up	68
Prefabricated Aluminum Headwalls	69
Prefabricated Aluminum Full Invert	72
Prefabricated Aluminum Footing Pads	75
Project Specifications	78

SUPER-SPAN™ / SUPER-PLATE®

Product Overview	79
Steel Project Specifications	83
Aluminum Project Specifications	85

BridgeCor®

Product Overview	88
Project Specifications	90
BridgeCor External Rib System	95
Round Design Details	97
Single Radius Arch Design Details	99
2-Radius Arch Design Details	101
Box Culvert Design Details	103

Steel EXPRESS® Foundations

Product Overview	108
Project Specifications	110

Outline of Typical Design Steps

The following steps describe a basic, typical procedure for designing a structural plate bridge or culvert but are not intended to represent all possible considerations that a prudent designer should investigate. Although not all of these steps will be covered in this document, additional design aids are available. If the designer has questions regarding an aspect of structure designs, the designer can contact the local Contech representative for additional information.

This guide follows the design methodology of the American Association of State Highway and Transportation Officials (AASHTO) LRFD Bridge Design Specifications. The height of cover tables will vary when a different design method is followed. **An HL-93 live load structural check determines if an HS-20 or a tandem axle vehicle controls. For other design load considerations, please contact your local Contech representative.**

Design Sequence

1. General Structure Selection
 - Guidelines for selection of hydraulic, roadway, pedestrian, or grade separation structure
2. Additional Selection Considerations
 - Refining structure selection, such as clearance requirements, if applicable
3. Check Service Life and Protection of Structure from Environment
 - Environmental effects
 - Design life
 - Material selection – galvanized steel or aluminum
 - Protection from aggressive environments
 - De-icing salts
4. Check Structure Hydraulics (not covered herein)
 - Perform hydraulic checks
 - Hydraulics of corrugated metal structures
 - Tools for hydraulic analysis*
 - Scour analysis
5. Check Structural Design
 - Design method options
 - » American Association of State Highway and Transportation Officials (AASHTO) LRFD or 2002 Standards
 - » American Iron and Steel Institute (AISI)
 - » National Corrugated Steel Pipe Association (NCSPA)
 - » American Railway Engineering and Maintenance Association (AREMA)
 - Material properties
 - Load rating structural plate (not covered herein)**

6. Specify Bedding, Backfill and Check Foundation
 - Soil envelope under and around structure
 - Bedding
 - Foundation requirements
 - » For arch structures, a reinforced concrete footing may be required. Please see page 108 for Contech's Steel EXPRESS® Foundation option.
 - Backfill envelope – backfill recommendations
7. Structure End Treatment
 - Projecting Square Ends
 - Beveled Ends
 - Skewed Ends
 - Headwalls
 - Toewalls and cutoff walls
8. Structure Installation Specifications
 - AASHTO LRFD Bridge Construction Section 26
 - ASTM A807 for Steel Structures
 - ASTM B789 for Aluminum Structural Plate







References

1. AASHTO Material, Design, and Installation Specifications
 - MULTI-PLATE, SUPER-SPAN, Aluminum Structural Plate, Box Culvert and BridgeCor – material design and installation
 - Project specifications
2. CAD Drawings
 - Structure shape and detail drawings are available to the designer upon request.
3. An NCSPA Corrugated Steel Pipe Design Manual is available from the NCSPA or your local Contech representative. More specific information on each step or topic is available from Contech Engineered Solutions.

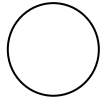
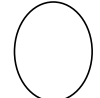
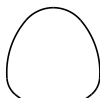
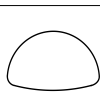
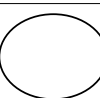
These are the basic steps involved in designing a corrugated flexible structure. This guide contains specific information about MULTI-PLATE, Aluminum Structural Plate, Aluminum Box Culverts, SUPER-SPAN/SUPER-PLATE, and BridgeCor.

* Hydraulic nomographs and FHWA HY-8 program assistance is available from your local Contech representative.

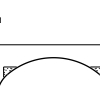
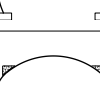
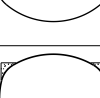
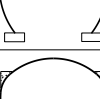
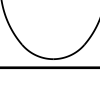
** Structures can be load rated according to AASHTO LRFR methodology, please contact your Contech representative for the NCSPA Design Data Sheet 19, which may be used for guidance.

STRUCTURE SHAPE GEOMETRY						
Shapes		Span x Rise	Common Uses	Steel	Aluminum	Trade Name
Round		5' to 50'-6"	Culverts, storm sewers, aggregate tunnels, vehicular and pedestrian tunnels and stream enclosures. Functions well in all applications, but especially in those with high cover	x		MULTI-PLATE BridgeCor
					x	Aluminum Structure Plate
Vertical Ellipse		4'-8" x 5'-2" to 25' x 27'-8"	Culverts, storm sewers, service tunnels, recovery tunnels and stream enclosures. Works well in higher cover applications.	x		MULTI-PLATE
					x	Aluminum Structure Plate
Underpass		12'-2" x 11'-0" to 20'-4" x 17'-9"	Offers efficient shape for passage of pedestrians or livestock, vehicular traffic and bicycles with minimal buried invert.	x		MULTI-PLATE
					x	Aluminum Structure Plate
Pipe-Arch		6'-1" x 4'-7" to 20'-7" x 13'-2"	Limited headroom. Has hydraulic advantages at low flow levels. Culverts, storm sewer, underpass and stream enclosures.	x		MULTI-PLATE
					x	Aluminum Structure Plate
Horizontal Ellipse		7'-4" x 5'-6" to 14'-11" x 11'-2"	Culverts, bridges, low cover applications, wide centered flow, good choice when poor foundations are encountered.	x		MULTI-PLATE
					x	Aluminum Structure Plate
Arch (single radius)*		6' x 1'-10" to 54'-4" x 27'-2"	Low clearance, large waterway opening. Aesthetic shapes and open natural bottoms for environmentally-friendly crossings.	x		MULTI-PLATE BridgeCor
					x	Aluminum Structure Plate
Arch (2-radius)*		18'-5" x 8'-4" to 50'-7" x 19'-11"	Low clearance, large waterway opening. Aesthetic shapes and open natural bottoms for environmentally-friendly crossings.	x		BridgeCor
Box Culvert		8'-9" x 2'-6" to 40'-9" x 15'-2"	Very low, wide bridges, culverts and stream enclosures, with limited headroom. Functions well as a fast small-span bridge replacement.	x		BridgeCor
					x	Aluminum Box Culvert
Low-Profile Arch		19'-5" x 6'-9" to 45'-0" x 18'-8"	Culvert, storm sewers, low headroom and large opening. Bridge structures, stream enclosures. Aesthetic shapes and open natural bottoms for environmentally friendly crossings.	x		SUPER-SPAN
					x	SUPER-PLATE***
High-Profile		20'-1" x 9'-1" to 35'-4" x 20'-0"	Culverts, storm sewers, bridges, Higher rise, large area opening. Open natural bottoms for environmentally friendly crossings.	x		SUPER-SPAN
					x	SUPER-PLATE
Horizontal Ellipse		19'-4" x 12'-9" to 37'-2" x 22'-2"	Larger culverts and bridges. Low headroom, wide-centered flow, good choice when poor foundations are encountered.	x		SUPER-SPAN
					x	SUPER-PLATE
Pear-Arch		23'-11" x 23'-4" to 30'-4" x 25'-10"	Railroad underpasses or large clearance areas. Open natural bottoms for environmentally friendly crossings.	x		SUPER-SPAN
Pear		23'-8" x 25'-5" to 29'-11" x 31'-3"	Railroad underpasses or large clearance areas.	x		SUPER-SPAN
Elliptical/Circular Arch **		12' to 102'	Culverts, bridges, tunnels, wetlands crossings, overpass/underpass, underground containment, wine/cheese cellars and shelters.			CON/SPAN® BEBO® (precast concrete)
Vehicular **		spans up to 300' spans up to 150'	County, city, parks, industrial complexes. Recreational, overpasses, industrial conveyor, pipe support.	x		Steadfast Bridges® Vehicular Truss Big R Bridge® Rolled Girder

* Larger steel sizes are available up through 80-foot spans with external reinforcements in the BridgeCor® product line. Contact your local Contech representative for more information.

** The design process for these bridge structures is not covered in this document. Contact your local Contech representative for more information.

*** Low-Profile Arch SUPER-PLATE is only available up to 38'-8" x 15'-9".

Selection of Structure Shape

Contech manufactures and supplies structural plate in a wide variety of structure shapes and sizes in both galvanized steel and aluminum alloy. The large selection of structure types ensures that a designer will be able to select the optimum structure for virtually any application from low cover situations to extreme cover heights and from pedestrian underpasses to grade separations for airport runways or railroad passages.

The structures listed on page 4 are generally configured for use in specific drainage or traffic passage applications. They are prioritized from top to bottom to ensure the most efficient usage and best economy. For example, a designer should first check to see if a round structure will satisfy the project requirements. If there is inadequate headroom for a round structure, proceed to a pipe-arch, horizontal ellipse, or arch and on to box culverts. If a larger structure is required, consider a SUPER-SPAN or BridgeCor type structure. More detailed structure dimensions and information can be found in later sections of this document.

Following are some tips on structure shape and size selection:

- ✓ It is usually best to select a shape that most closely matches the shape of the drainage channel. For example, a deep narrow channel will accept a round structure. horizontal ellipses, low profile arches and box culvert shapes are best suited to relatively wide, shallow channels.
- ✓ Determine the end area requirement in square feet for the structure and divide the number by the vertical distance from the streambed to the surface elevation less approximately 1.5' to 3.0' for fill cover over the structure. This will somewhat underestimate the approximate minimum span required depending upon the structure shape.
- ✓ Identify the most efficient structure in terms of reducing design loads. For box culverts, choose a structure that meets the hydraulic requirements and provides a cover of 3-4 feet. A taller structure which minimizes cover may be less cost-effective than one of similar span with slightly higher cover.
- ✓ For other plate structures:
 - Where fill over the structure is high, try to utilize the tallest structure feasible to minimize cover. As cover increases, so does gage as well as footing sizes.
 - Where fill over the structures is low, choose a structure that maintains the minimum allowable cover.

Additional Considerations

In addition to simple geometric and hydraulic concerns, the designer should consider other parameters that may influence structure type, shape and material including:

- **High Cover Applications**

For fill heights over 30', the designer should consider Key-Hole Slot MULTI-PLATE® as discussed on page 16.

- **Pipe Structure versus Arch on Footings**

In general, a pipe structure with a full invert or buried invert is preferable in terms of cost versus an arch because of the elimination of concrete footings. However, many regulations require natural, undisturbed stream bottoms. In this case, an arch on footings is typically less expensive than a traditional bridge.

- **Bearing Capacity**

See specific sections in this guide for individual structure types for recommendations on minimum bearing capacity and footing designs. **Pipe arch design should include considerations of applied corner bearing pressure.**

- **Flow Characteristics**

If flow is to be particularly abrasive, the designer should consider a natural invert (arch or buried invert), heavier invert plates, an aluminum structure, or applying a paved invert to aid in the long-term durability of the structure.

- **Corrosive Soils**

Analyze structure life projections based upon the CALTRANS/AISI method. If design life is not met using galvanized steel, consider asphalt coating the steel, adding a concrete field paved invert or using aluminum as an alternate. See page 11 for recommendations for protection from de-icing salts.

- **Corrosive Effluents**

Analyze structure invert life projections based upon the CALTRANS/AISI method. If design life is not met using galvanized steel, consider either heavier gage invert plates, paved invert, natural invert, or aluminum. In particularly corrosive situations an arch on elevated footing walls (pedestal walls) may be the best solution.

Scour

If scour is a concern, a pipe structure, especially with a buried invert, may be more desirable than an arch. The invert eliminates footings subject to scour. Also, arches with partially buried structure legs (and footings) may satisfy scour depth. Often, when an arch on footings must be used, protecting the footings, may be more cost effective than installing deeper footings. Products to consider for this type of protection include rip-rap, sheet piling, or as a permanent erosion control option, Armortec hard armor solutions. Scour analysis is outside the scope of this guide.

FHWA Hydraulic Engineering Publication HEC-18 outlines the design for scour. FHWA Hydraulic Engineering Publication HEC-23 outlines the design procedures for scour counter measures.



Protect footings from scour with Armortec® hard armor solution



Horizontal ellipse SUPER-SPAN™

Clearance Box Requirements

The following describes the process of selecting a structure with sufficient clearance for the passage of vehicular or pedestrian traffic.

It should be noted that the dimensions of finished corrugated metal structures may differ from the nominal dimensions described in literature. For instance, taller single radius arches may peak slightly during backfilling, which may infringe upon the required clearance box.

If clearance tolerance is critical, it is recommended that a slightly larger structure be selected or that the structure shape be monitored during erection and backfilling. Proper control of compaction and the use of high quality granular backfill material will minimize structure movement during backfilling. Contact your Contech representative for assistance regarding monitoring and the use of particular shapes.

MULTI-PLATE® and Aluminum Structural Plate vertical ellipses and underpass shapes are configured specifically for vehicular and pedestrian traffic. The structure's invert is often paved to provide a smooth surface. See page 12 for details.

While arch structures often appear to be the best choice for many applications, the same shape in a round or elliptical shape may be more economical due to the elimination of footings. For example, a round structure or horizontal ellipse with the invert buried and/or paved are often used in lieu of an arch for grade separation structures.

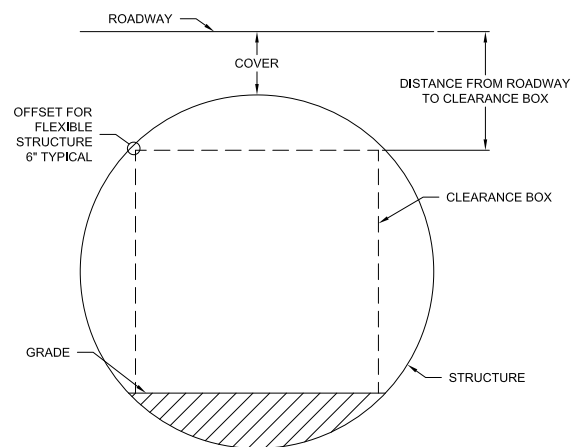

TYPICAL CLEARANCE BOX DETAIL

Designing For Service Life

After a structure shape, size, and gage have been selected, the designer should perform an analysis of the possible environmental effects on the structure's long-term life cycle. This may lead the designer to modify the structure's material, structure type, coating, or additional invert protection.

A structure's life cycle can be affected by the corrosive action of the backfill in contact with the outside of a structure or more commonly by the corrosive and abrasive action of the flow in the invert of the structure. The design life analysis of the structure should include a check for both water side and soil side environments to determine which is most critical or which governs structure life.

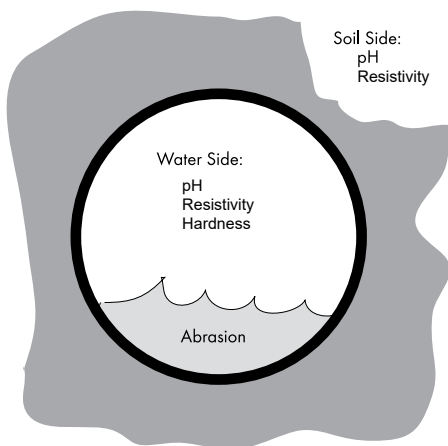

The choice of material or structure type can be extremely important to service life. For example, if it is determined that water and bedload flowing through a structure is projected to reduce the life cycle of the invert through abrasive or corrosive action, an arch may be used with a natural invert or the invert may be buried or paved.

Corrosion Studies for Metal Structures

Galvanized steel structural plate has been used in the United States since 1931. Aluminum Structural Plate has been in use since the early 1960's. Tens of thousands of structures are in use in a wide variety of applications and environments. This wealth of experience provides unsurpassed "in-the-ground" knowledge of performance. Several rational methods exist for determination of the effects of corrosion upon galvanized steel and aluminum drainage structures. Numerous federal agencies, including the Federal Highway Administration and U.S. Army Corps of Engineers as well as a large number of state departments of transportation, have published guidelines on the subject. All have valuable information pertinent to possible corrosive effects on both steel and aluminum materials.

Galvanized Steel MULTI-PLATE®

With regard to the durability of galvanized steel MULTI-PLATE, this design guide will outline the guidelines established by the California Department of Transportation (CALTRANS). The CALTRANS design method originated from a study that inspected over 7,000 galvanized steel corrugated metal pipe (CMP) drainage structures throughout the state of California. Through this field study they were able to develop a reliable method for predicting the service life of smaller diameter corrugated galvanized steel pipes. The data collected reflected the combined effects of corrosion and a wide range of abrasive levels. The conclusion of the CALTRANS study defined the end of the structure life to coincide with the first perforation (or approximately 12% metal loss) in the invert of culverts that have received no special maintenance.

The service life of 2 oz. per square foot of zinc-coated galvanized CMP is determined by using the CALTRANS chart for estimating invert life (see page 8). This chart predicts a variable service life based on pH and resistivity of water and soil and has been the industry standard for many years. The results included the combined effects of soil-side and interior corrosion, as well as the average effects of abrasion. For pipes where the pH was greater than 7.3, soil-side corrosion controlled and life was predicted by resistivity. For pipes where pH was less than 7.3, the interior invert corrosion generally controlled and both pH and resistivity were important.

It is important to note, the consequences of small perforations are minimal in gravity flow pipe systems, such as most storm sewers and larger culverts, and may not accurately reflect the estimated service life outlined by CALTRANS. Because of this fact, the original CALTRANS curves have been converted to average service life curves using data on weight loss and pitting in bare steel developed by National Institute of Standards and Technology. Using this information, the American Iron and Steel Institute (AISI) developed a durability chart using the end of an average effective service life to be estimated at approximately a 25% metal loss in the invert. The AISI chart can be found at NCSPA.org.

In addition, the structural plate covered in this design guide utilizes a 3 oz. per square foot of zinc coating and uses heavier gage material as part of the structural design. This is a 50% increase in additional barrier coating and adds additional base metal thickness that was not investigated in the original CALTRANS study. These two additional key factors will provide a longer service life than predicted in these charts.

If the designer has site specific knowledge and understands the key design parameters, the AISI method may be more applicable in the pipe service life design. Many state DOT's find the CALTRANS method to be a conservative estimate of the average observed service life of galvanized steel structures in their states.

Figure 1. CALTRANS Chart For Estimating Average Invert Life For Plain Galvanized Culverts

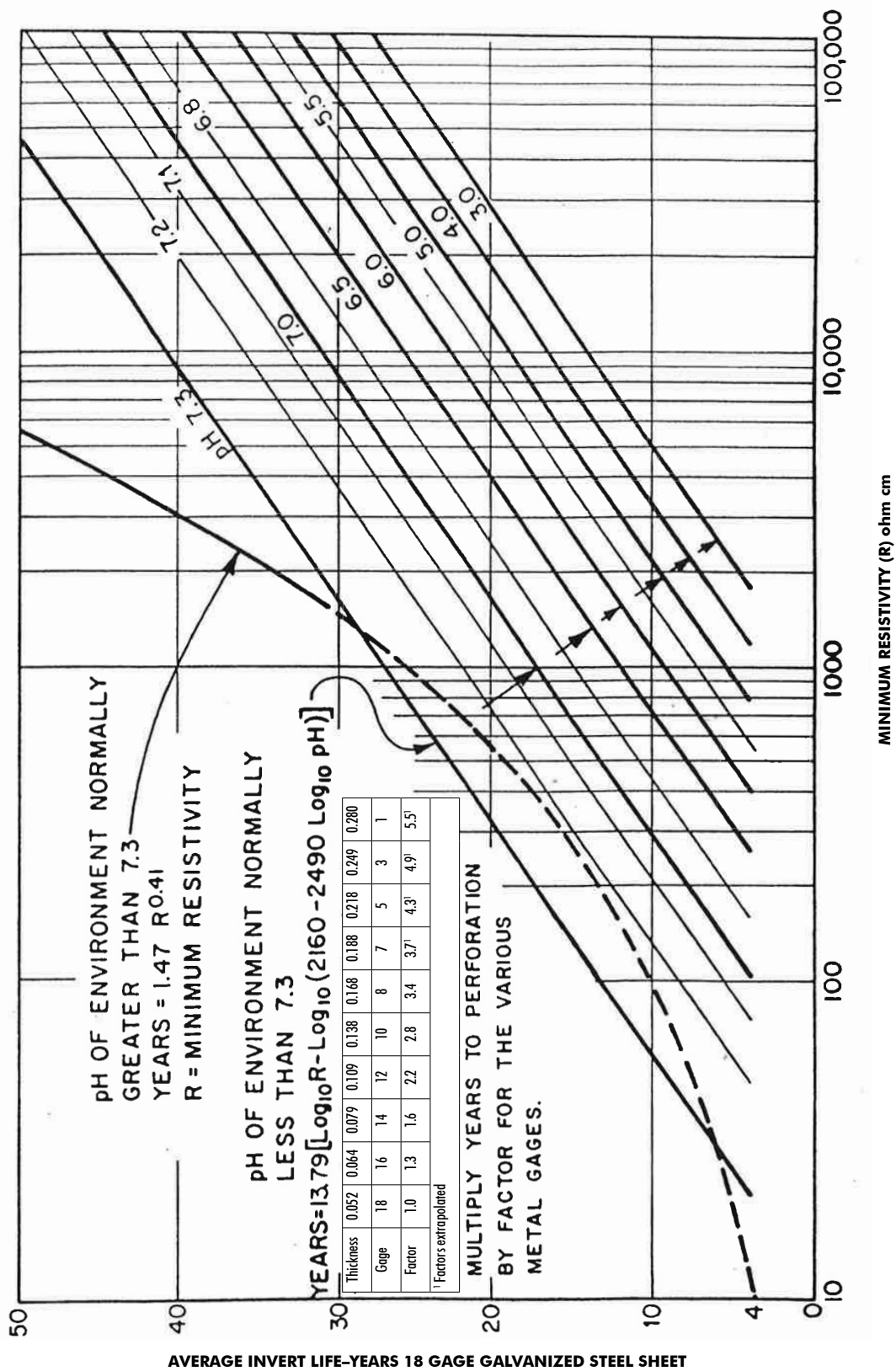

Although a gravity flow drainage structure of any kind functions properly well beyond the occurrence of the first perforation, the use of the CALTRANS method best illustrates the variety of environmental conditions found throughout the country.

An important factor when choosing a design method, either CALTRANS or AISI, is knowledge of the structure backfill type. A structure backfilled with very fine material may be affected by the loss of this material through perforations. Thus, the CALTRANS method may be valid. If the required backfill is more granular, which is usually the case with plate structures, then first perforation is probably inconsequential and, therefore, the AISI method would be more appropriate.

For added service life with steel structures, an optional polymer coating may be applied to the plates. Please refer to page 27 for specification information.

Hard or Soft Water Considerations

The designer should note that other factors will affect the rate of metal loss. The primary factor is the presence of dissolved salts such as CaCO₃ and MgCO₃. Total hardness is a measure of the level of dissolved salts and defined water runoff as hard or soft water.

Hardness levels greater than 300 mg/L indicate dissolved salts (hard water) of a level that will cause the formation of a mineral "scale" on the galvanized surface that will provide excellent protection and increased service life in the absence of abrasion. Inspections have shown 50-year-old structures with mineral scale and pristine metal conditions beneath.

Hardness levels below 300 mg/L warrant further consideration by the designer and the possible use of coatings, invert protection/paving or aluminum.

In general, the recommended environmental range for use of galvanized steel structural plate that will provide a minimum service life of 50 years is a pH from 6 through 10, and a resistivity of 2,000 ohm-cm through 10,000 ohm-cm**

* Values greater than 10,000 ohm-cm for water side resistivity may indicate low level of dissolved salts (soft water). Water hardness should be tested. Additional protection may be required to meet the required design service life.

Aluminum Structural Plate

Studies similar to those conducted by CALTRANS have been performed upon a large number of Aluminum Structural Plate installations for the same purpose although none have produced a mathematical model like that for galvanized steel. Aluminum loss rates have been so low as to preclude a reliable model.

Aluminum alloy reacts much differently than galvanized steel when in contact with air, soil, and water. Instead of zinc/steel system of galvanic protection, aluminum resists corrosion by a passive formation of a very tenacious aluminum-oxide layer on its surface. This oxide layer has been shown in field and laboratory observation to be stable in an environment of pH between 4 and 9 and resistivity greater than 500 ohm-cm. Within this range, corrosion rates are minimal and prediction of service life is a matter of assigning a pit rate based upon laboratory testing. Conservatively, a pit rate based on 0.001"/yr may be used.

In this case:

$$0.100" \text{ thick plate } 0.001"/\text{yr} = 100 \text{ yrs design life.}$$

Actual field observations of aluminum alloy pipe (ALCLAD) and Aluminum Structural Plate support this estimation.

In tidal brackish and saltwater environments, Aluminum Structural Plate will perform well if backfilled with free-draining material. The pH and resistivity requirements outlined previously must also be met. Sea water normally exhibits a pH range of 7.5 through 8.0 and resistivity that is less than 100/ohm-cm, but given the neutral pH and a free draining backfill, Aluminum Structural Plate still performs well.

For more detailed information on the subject of corrosion or copies of the referenced documents or guidelines, contact your Contech representative.



**72-Year-Old Steel Structural Plate Pipe Arch
Installed c. 1940 | Inspected in 2012**

Abrasion Considerations

The potential for metal loss in the invert of a drainage structure due to abrasive flows is often overlooked by designers, and its effects are often mistaken for corrosion. Environments conducive to abrasive flows are well defined but due to the periodic nature of this event, it is easy to miss.

Three factors must combine to cause invert abrasion:

- Abrasive bedload
- Sufficient velocity to carry the bedload
- Flow duration and frequency

Examples of abrasive materials include but are not limited to sands, gravels, and stone. The designer should not underestimate the abrasive action of sand transported in sustained flows. When flow velocities reach approximately 5-6 feet-per-second, sand and gravels can become mobile or suspended.

Most commonly, abrasive bedloads remove protective mineral scale and produce oxidation on galvanized steel which will accelerate corrosion. Upstream stilling basins that allow abrasive particles to settle or drop out prior to entering the structure can be very effective in extending the service life.

Guidelines for abrasion levels are excerpted from the FHWA Memorandum on Design Guidance and Specification Changes for Drainage Pipe Alternative Selection and are shown on the next page.

Both of these factors, velocity and abrasiveness, may be present at a particular site. However, if the flow necessary to carry the bedload occurs only a few times during the life of the structure, abrasion may not be a concern. The designer should refer to the 2- or 5-year event velocity and then use this to decide if abrasion is a valid concern.

Should abrasion be determined to be a limiting factor in structure life, several solutions are available to the designer. These solutions include:

- Use of a structure with a buried invert
- Use of an arch structure
- Concrete invert pavement (see page 12)
- Heavier gage invert plates
- Stilling basins near the invert

Aluminum performs better than galvanized steel when subjected to abrasion. In some cases, the formation of the oxidized steel layer (in hard water) is removed by abrasion, exposing the galvanized coating beneath. After years of abrasion have taken place, the protective galvanized coating is abraded away and corrosion of the bare steel begins. This corrosion/abrasion cycle continues for the life of the structure.

Aluminum may lose its oxide layer when abraded away but it quickly reforms at low flows, therefore limiting corrosion. Aluminum does not have a protective coating to lose after years of abrasive flow.

This is not meant to suggest that Aluminum Structural Plate should be used in heavily abrasive environments. However, its performance can be expected to be superior to plain galvanized steel.

FHWA Memorandum on Design Guidance and Specification Changes for Drainage Pipe Alternative Selection

The durability and service life of a drainage pipe after installation is directly related to the environmental conditions encountered at the site and the type of materials and coatings from which the culvert was fabricated. Two principal causes of early failure in drainage pipe materials are corrosion and abrasion. The environmental damage caused by corrosion and abrasion can be delayed by the type of materials, coatings and invert protection.

It is the Federal Lands Highway (FLH) policy to specify alternative drainage pipe materials on projects where feasible and to comply with the provisions of the Federal-Aid Policy Guide Section 611.411(d). All permanent drainage pipe installations shall be designed for a minimum of 50 years with a maintenance-free service life. A shorter service life may be used for temporary installations, and a longer service life may be considered in unusual situations.

All suitable pipe materials, including reinforced concrete, steel, aluminum and plastic pipe shall be considered as alternatives on FLH projects. The portion of this pipe selection criteria covering metal pipe complies with the guidance contained in Federal Highway Administration (FHWA) Technical Advisory T 5040.12 dated October 22, 1979, and incorporates information contained in FHWA-FLP-91-006, Durability of Special Coatings for Corrugated Steel Pipe.



Bay of Fundy | Robinston, ME
52-Year-Old Aluminum Structural Plate
Installed in 1966 | Inspected in 2018

Abrasion: An estimate of the potential for abrasion is required at each pipe location in order to determine the need for invert protection. Four levels of abrasion are referred to in the FHWA guidelines and the following guidelines are established for each level:

- **Level 1: Nonabrasive** conditions exist in areas of no bed load and very low velocities. This is the condition assumed for the soil side of drainage pipes.
- **Level 2: Low abrasive** conditions exist in areas of minor bed loads of sand and velocities of 5 feet per second (1.5 meters per second) or less.
- **Level 3: Moderate abrasive** conditions exist in areas of moderate bed loads of sand and gravel and velocities between 5 and 15 fps (1.5 m/s and 4.5 m/s).
- **Level 4: Severe abrasive** conditions exist in areas of heavy bed loads of sand, gravel, and rock and velocities exceeding 15 fps (4.5 m/s).

These definitions of abrasion levels are intended as guidance to help the designer consider the impacts of bedload wear on the invert of pipe materials. Sampling of the streambed materials is not required, but visual examination and documentation of the size of the materials in the streambed and the average slope of the channel will give the designer guidance on the expected level of abrasion. Where existing culverts are in place in the same drainage area, the existing conditions of inverts can be used as guidance. *The expected stream velocity should be based upon a typical flow and not a 10- or 50-year design flood.*

Corrosion: Alkalinity/Acidity (pH) and Resistivity—Determinations of pH and resistivity are required at each pipe location in order to specify pipe materials capable of providing a maintenance free service life. The samples shall be taken in accordance with the procedures described in AASHTO T 288 and T 289. Samples should be taken from both the soil and water side environments to ensure that the most severe environmental conditions are selected for determining the service life of the drainage pipe. Soil samples should be representative of backfill material anticipated at the drainage site. Avoid taking water samples during flood flows or for two days following flood flows to insure more typical readings. In locations where streams are dry for much of the year, water samples may not be possible or necessary. In areas of known uniform pH and resistivity readings, a random sampling plan may be developed to obtain the needed information.

In corrosive soil conditions where water side corrosion is not a factor, consider specifying less corrosive backfill material to modify the soil side environment. The advantages of properly specified backfill should be taken into account in making alternative pipe materials selections in situations where soil side conditions control.

Adjustments for Abrasion

Once the minimum structural gage is selected and the service life requirement is compared to “The CALTRANS Chart for Estimating Average Invert Life” (on page 8) adjustments should be made based on the abrasion potential of the site.

Steel

At **non-abrasive** or **low abrasive** sites, no additional protection is needed. At sites that are **moderately abrasive**, increase the thickness of the material by one standard thickness or add invert protection like a concrete paved invert. At **severely abrasive** sites, increase the thickness of the material by one standard thickness and add a concrete paved invert.

Aluminum

At **non-abrasive**, **low abrasive** or **moderately abrasive** sites, no additional protection is needed. At **severely abrasive** sites, increase the thickness of the material by one standard thickness and add a concrete paved invert.

Additional Service Life Considerations

Dissimilar Metals

Metals with a substantial difference in electrical potential should be insulated from each other. Electrical potential may be established by referring to the electromotive scale. The only significant concern with regard to structural plate is the use of “black” steel in conjunction with aluminum. Black steel should not be in contact with aluminum. Hot Dipped Galvanized steel is compatible with Aluminum Structural Plate.

Concrete or Grout in Contact with Aluminum

During the relatively short period while concrete cures, minor etching (<0.001”) of the surface of the plate will occur. If the designer is concerned with cosmetic etching of the aluminum, the surface may be coated with asphalt or primer paint.

De-icing Salts

The potential for use of de-icing salts on roadway surfaces above structural plate must be addressed during the design phase. Calcium chloride and magnesium chloride as well as other de-icing materials can cause corrosion of galvanized steel and aluminum.

It is recommended that the designer consider the use of either an asphalt coating on the exterior of the structure or a HDPE membrane over the structure. Details for each of these solutions are presented on the following pages.

In addition, impermeable clay layers above the select backfill have been used to shed water from the crown of the structure.

HDPE Membrane Protection Detail for Structural Plate

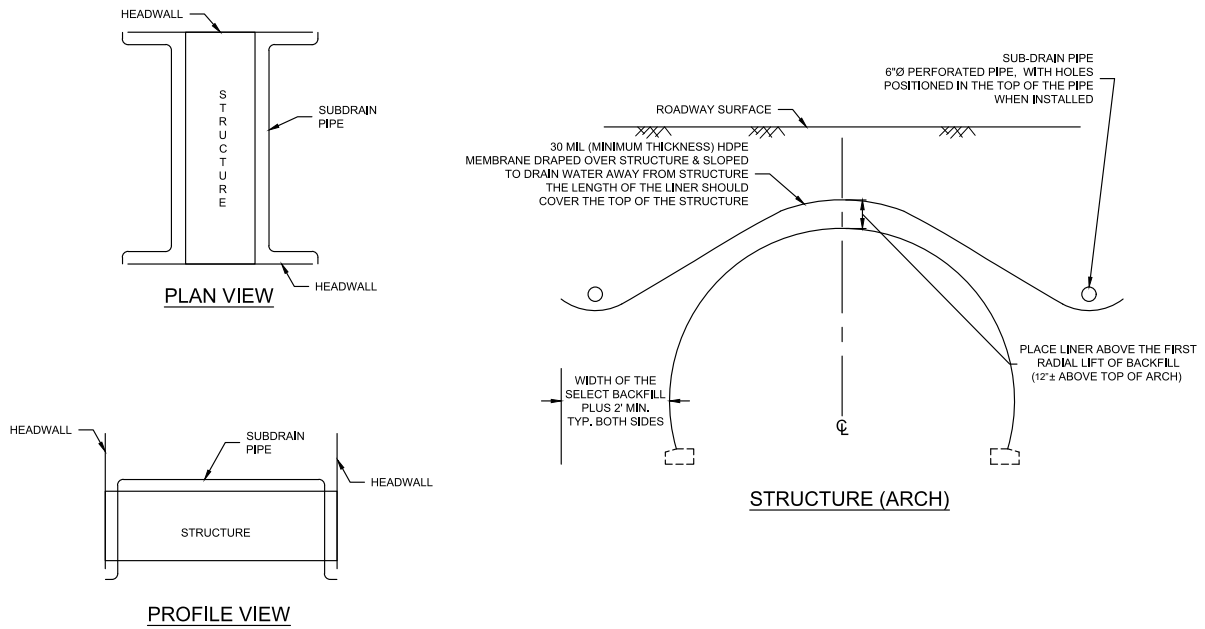

Structural Plate Detail for Concrete Paved Invert

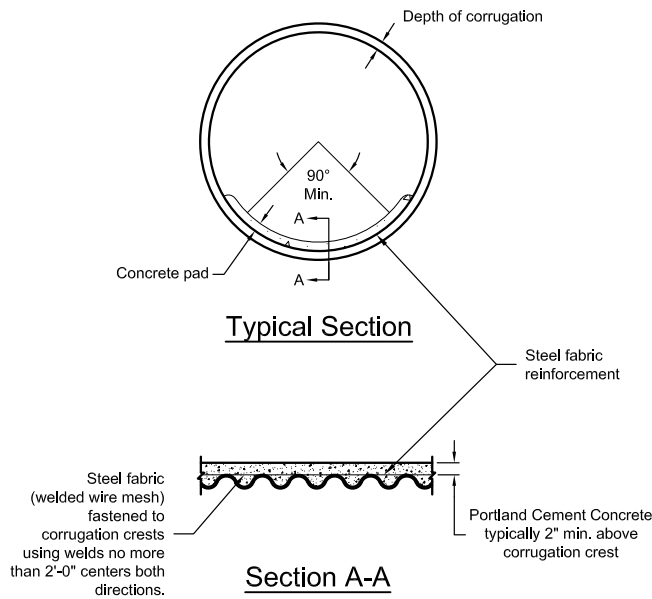

Structural Plate Design

MULTI-PLATE® and Aluminum Structural Plate

Determination of Metal Thickness

According to the American Association of State Highway and Transportation Officials (AASHTO) LRFD Design Specification, Section 12.2 for corrugated metal plate structures "...become part of a composite system comprised of the metal pipe section and the soil envelope, both of which contribute to the structural behavior of the system."

Design methods for corrugated metal plate structures are well established and provide the designer with straightforward, conservative procedures. Current AASHTO design procedures also address foundations, backfill, and end treatments. (See page 27 for listing of all applicable design specifications.)

The basic plate structural design process for the determination of the structure gage consists of:

1. Determine the backfill soil density adjacent to and above the metal structure.
2. Calculate the design pressure applied by the soil column and live load.
3. Compute the compressive thrust in the structure wall.
4. Determine the required thickness based upon checks for wall yielding and buckling using the corrugated section properties.
5. Check for sufficient bolted longitudinal seam strength between plates.
6. Check for minimum stiffness required for proper handling, assembly, and installation.
7. Apply appropriate LRFD factors.

Dead Loads

Dead loads are those developed by the soil fill above the structure plus those of any stationary surcharge loads that can influence the structure. Dead loads are calculated by multiplying the soil density by the height of cover and applicable load and redundancy factors. The unit weight of soil is assumed to be 120 pcf unless otherwise stated.

Live Loads

Live loads reaching the structure are more complicated to determine. AASHTO has prepared a very comprehensive method for determination of the loads reaching the corrugated metal structure.

Live loads consist of traffic loads applied to the surface or roadway above the structure. These loads also consider the effect of impact loads. Live loads reaching the structure diminish with increasing heights of cover. Overall, this manual considers HL-93 highway loads. Other highway loads, such as HS-20 and HS-25, can be addressed. Cooper (E-80) railroad loads are addressed in the American Railroad Engineering and Maintenance-of-Way Association (AREMA) specification which is similar to the procedure outlined. Airport loading and off-highway loads such as mining equipment are special loading conditions. For additional design support, contact your local Contech representative.

AASHTO Design Load and Redundancy Factors

The AASHTO design load factors that are required to perform the calculation are summarized in the table below.

Symbol	Term	Value	AASHTO
Φ_W	Wall Area and Buckling	1.00	(Table 12.5.5-1)
Φ_{SS}	Seam Strength	0.67	(Table 12.5.5-1)
Φ_{BP}	Backfill Bearing Resistance	1.00	(Table 12.5.5-1)
η_{EV}	Redundancy Factor	1.05	(1.3.4, 12.5.4)
η_{LL}	Redundancy Factor	1.00	(1.3.4, 12.5.4)
γ_{EV}	Dead Load Factor	1.95	(Table 3.4.1-2)
γ_{LL}	Live Load Factor	1.75	(Table 3.4.1-1)

For additional information on the methodology for developing these load pressures or AASHTO, AISI, and AREMA tables, contact your local Contech representative.

Structural Plate Design - Seam Strength

When the design analysis shows the seam strength of a structure is the limiting factor, which can occur when fill heights become significant, the design engineer can increase the material thickness to add seam strength for a particular design.

TABLE 2.
ULTIMATE SEAM STRENGTH
OF BOLTED 6" X 2" STEEL STRUCTURAL PLATE LONGITUDINAL SEAMS
IN POUNDS PER FT OF SEAM

Gage	Thickness (Inches)	6" x 2" Corrugation		
		4 Bolts Per Ft.	6 Bolts Per Ft.	8 Bolts Per Ft.
12	0.111	42,000		
10	0.140	62,000		
8	0.170	81,000		
7	0.188	93,000		
5	0.218	112,000		
3	0.249	132,000		
1	0.280	144,000	180,000	194,000
5/16	0.318			235,000
3/8	0.380			285,000

Notes:

1. Bolts used are 3/4" diameter – high strength bolts with suitable nuts, meeting ASTM A449.
2. Bolts and nuts also used for connecting arch plates to receiving angles and structural reinforcement to structural plates.
3. 5/16 and 3/8 require 7/8" fasteners.

TABLE 4.
ULTIMATE SEAM STRENGTH
OF BOLTED ALUMINUM STRUCTURAL PLATE LONGITUDINAL SEAMS
IN POUNDS PER FT OF SEAM

Thickness (Inches)	Ultimate Seam Strength
0.100	28,000
0.125	41,000
0.150	54,100
0.175	63,700
0.200	73,400
0.225	83,200
0.250	93,100

Note: Bolts used are 3/4" diameter – high strength bolts with suitable nuts, meeting ASTM A307/A449.

TABLE 3.
ULTIMATE SEAM STRENGTH
OF BOLTED 15" X 5 1/2" STEEL STRUCTURAL PLATE LONGITUDINAL SEAMS
IN POUNDS PER FT OF SEAM

Gage	Thickness (Inches)	15" x 5 1/2" Corrugation	
		30" long plates	45" long plates
8	0.170	109,000	89,000
7	0.188	126,000	101,000
5	0.218	155,000	124,000
3	0.249	181,000	160,000
1	0.280	187,000	162,000
5/16	0.318	231,000	n/a
3/8	0.380	252,000	n/a

Notes:

1. Bolts used are 3/4" diameter – high strength bolts with suitable nuts, meeting ASTM A449.
2. Bolts and nuts also used for connecting arch plates to receiving angles and structural reinforcement to structural plates.
3. 5/16 and 3/8 require 7/8" fasteners.
4. The values listed above are per ASTM A796.

See page 29 for MULTI-PLATE standard detail.
See page 48 for ALSP standard plate detail.
See page 89 for BridgeCor standard plate detail.



24'-0" diameter steel MULTI-PLATE® designed for 60 feet of fill owned by VDOT in Dryden, Virginia

Section Properties

TABLE 5. STEEL CONDUITS					
Gage	Thickness (Inches)	6" x 2" Corrugations			
		Area of Section A _s	Radius of Gyration r	Section Modulus S	Moment of Inertia I
		Sq. In./Ft.	(Inches)	In. ³ /In.	In. ⁴ /In.
12	0.111	1.556	0.682	0.0574	0.0604
10	0.140	2.003	0.684	0.0733	0.0781
8	0.170	2.449	0.686	0.0888	0.0962
7	0.188	2.739	0.688	0.0989	0.1080
5	0.218	3.199	0.690	0.1147	0.1269
3	0.249	3.650	0.692	0.1302	0.1462
1	0.280	4.119	0.695	0.1458	0.1658
5/16	0.318	4.671	0.698	0.1640	0.1900
3/8	0.380	5.613	0.704	0.1950	0.2320

TABLE 6. ALUMINUM CONDUITS				
Thickness (Inches)	9" x 2 1/2" Corrugations			
	Area of Section A _s	Radius of Gyration r	Section Modulus S	Moment of Inertia I
	Sq. In./Ft.	(Inches)	In. ³ /In.	In. ⁴ /In.
0.100	1.404	0.8438	0.767	0.0836
0.125	1.750	0.8444	0.951	0.1040
0.150	2.100	0.8449	1.131	0.1249
0.175	2.449	0.8454	1.309	0.1459
0.200	2.799	0.8460	1.484	0.1670
0.225	3.149	0.8468	1.657	0.1882
0.250	3.501	0.8473	1.828	0.2094

TABLE 7. MECHANICAL PROPERTIES FOR STEEL STRUCTURAL PLATE MATERIAL		
f _u Minimum Tensile Strength (psi)	f _y Minimum Yield Point (psi)	E _m Modulus of Elasticity (psi)
45,000	33,000	29 x 10 ⁶

Note: Material requirements based on AASHTO M 167

TABLE 8. MECHANICAL PROPERTIES FOR ALUMINUM STRUCTURAL PLATE MATERIAL			
Thickness (Inches)	f _u Minimum Tensile Strength (psi)	f _y Minimum Yield Point (psi)	E _m Modulus of Elasticity (psi)
0.100 to 0.175	35,000	24,000	10 x 10 ⁶
0.200 to 0.250	34,000	24,000	10 x 10 ⁶

Note: Material requirements based on AASHTO M 219, Alloy 5052



"The Chief" a 5,000,000 lb. drag line over steel SUPER-SPAN™ at Peabody Coal in Zanesville, Ohio

Key-Hole Slot MULTI-PLATE® Structures Under High Fill

MULTI-PLATE can be designed to handle high fill heights greater than 30' using Key-Hole Slot MULTI-PLATE. The slot provides self-indexing, controlled-yield bolted joints along a Key-Hole Slot MULTI-PLATE structure's longitudinal seams. These joints yield under compressive loads and thereby reduce the circumference of the structure, so that much of the load is carried by the soil instead of by the steel structure.

In effect, the Key-Hole Slot MULTI-PLATE becomes a yielding-ring structure. The design allows the seams to slip under load without any loss in ultimate seam strength. (See Figure 2).

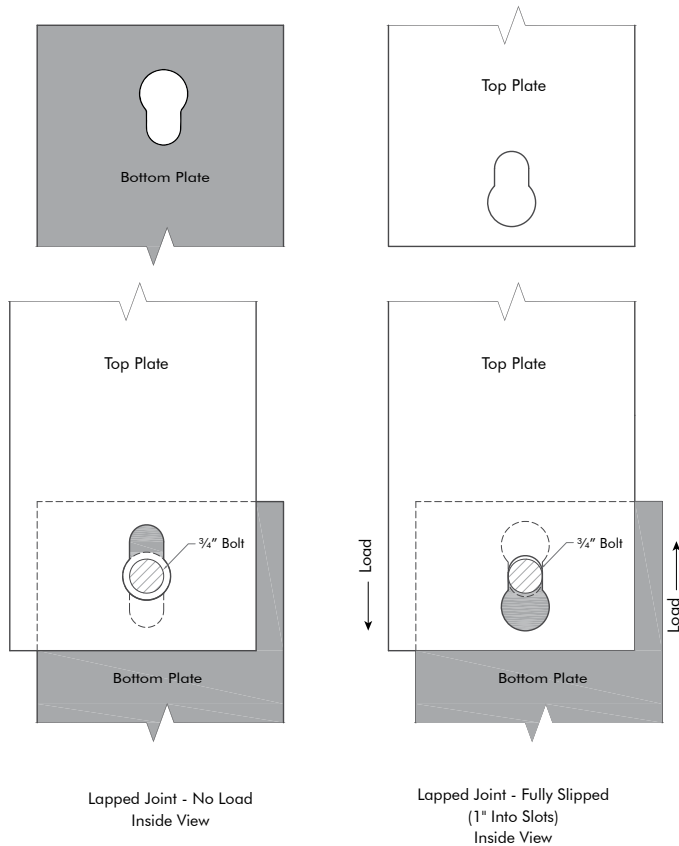

Figure 2. Key-Hole Slot MULTI-PLATE® at work

While specific design criteria must be applied to any project, the use of Key-Hole Slot MULTI-PLATE versus standard MULTI-PLATE can decrease the gage (material thickness) by one to three gages. A CALTRANS deep burial study compared standard MULTI-PLATE to Key-Hole Slot MULTI-PLATE and found that the average thrust created at the springline level of the Key-Hole Slot structure was approximately 50% of standard structure.

This reduction in thrust in turn reduces the required seam strength, and therefore, the structure wall gage or thickness. The designer is urged to contact a Contech representative for additional information on Key-Hole Slot MULTI-PLATE.



Along the Eastern Transportation Corridor in Orange County, California, this Key-Hole Slot MULTI-PLATE® structure was designed for the 115 ft. of cover.

Soil Arching

The compressive loads reach a level which varies by gage, causing the 3/4-inch bolt shank to wedge into the 5/8-inch slot. This controlled yielding action in the structure seams decreases the structure circumference, promoting a high degree of soil arching over the structure. For these deep cover applications, A-1-a backfill per AASHTO M 145 is required as backfill for these types of flexible structures.

Aluminum Box Culvert Design

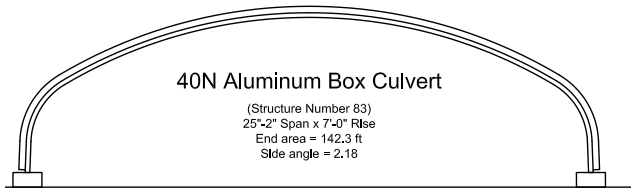

The structural design of an Aluminum Box Culvert (ALBC) does not follow the processes previously discussed in this guide. Due to the shape of the box culvert, the “ring compression” method used to quantify design pressures does not apply. The relatively large radius crowns are subject to high moment forces. Therefore, a separate method is used to ensure that the Aluminum Box Culvert can support both the earth loads and the live loads applied to these structures under relatively shallow fills. Primarily, the design procedure quantifies the capacity of the corrugated aluminum shell and reinforcing ribs to resist bending moments.

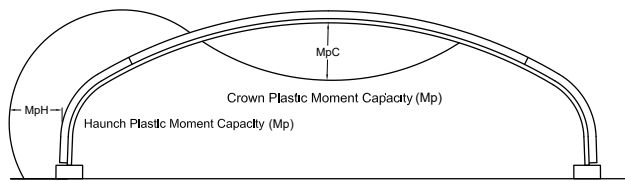

Due to the indeterminate nature of the structural elements, finite element analysis was developed to evaluate the plastic moment capacity of the structure. The design requirements for Aluminum Box Culverts are contained in the AASHTO Highway Bridge Design Manual Section 12.8.

Contech Engineered Solutions has also generated height of cover tables that meet the requirements of AASHTO for HL-93, HS-20, and HS-25 live loads that supply the plate gages and reinforcing ribs necessary for a given height of cover. These values are contained in the Aluminum Box Culvert section of this manual. Note that the allowable range of minimum and maximum cover heights is limited for aluminum box culverts. Additionally, live load is restricted to standard highway vehicles. **Heavy construction loads and other heavy live load traffic are not permitted over these structures without special provisions.**



Aluminum Box Culvert installation



Aluminum Box Culvert multi-cell installation

SUPER-SPAN™ and SUPER-PLATE® Design

Design of SUPER-SPAN and SUPER-PLATE (Long Span) structures follow AASHTO Section 12.7.

SUPER-SPAN and SUPER-PLATE feature relatively large radius or flatter curvature in the top or sides (larger than standard structural plate designs). These shapes include:

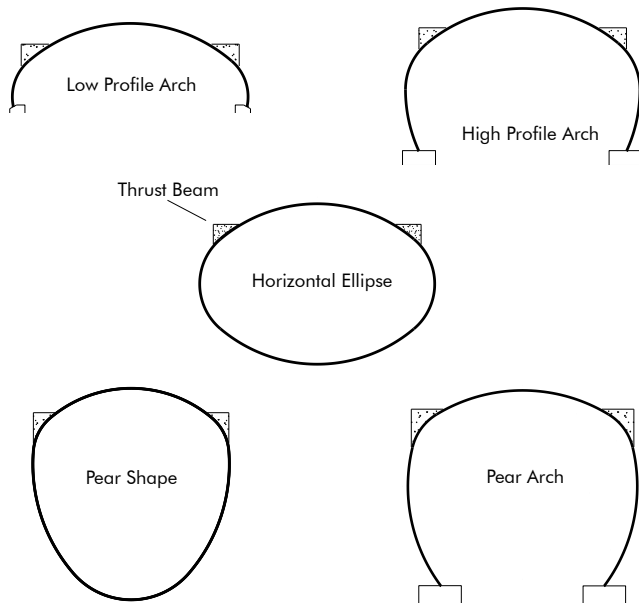

The primary differences in long span design procedures and standard plate structures design procedures are:

- Design checks for buckling and flexibility are not applied because of special features not found in other Structural Plate structures and also because of the use of high quality backfill and shape monitoring during backfill.
- Special features such as longitudinal thrust beams are incorporated to assist in the ability of the structure to transfer load to the surrounding soil envelope. Thrust beams also work to isolate the top arc, diminishing the need for a buckling analysis.

- Gage of the top plates and minimum cover are determined by the top radius (see Table 9)
- Maximum central angle of top is 80 degrees
- Ratio of top radius to side radius is equal to or greater than 2.0 and less than or equal to 4.4



SUPER-SPAN structure near Cumming, Georgia

Gage or thickness for SUPER-SPAN is a function of the structure's top radius and the live and dead loads. Table 9 below provides the recommended gages and minimum covers for SUPER-SPAN. The designer should also note that Contech Engineered Solutions provides a Shape Control Technician as a condition of the sale of a SUPER-SPAN or SUPER-PLATE. The Shape Control Technician will be on-site until the select backfill reaches the minimum height of cover required to ensure proper finished structure shape.

Aluminum SUPER-PLATE long spans are available in most of the same sizes and shapes as steel SUPER-SPAN.

Further information is available in the SUPER-SPAN and SUPER-PLATE section of this design guide and technical guidelines contained in this brochure.

TABLE 9.
MINIMUM THICKNESS — MINIMUM COVER TABLE (HL-93, H-20, HS-20, H-25, HS-25 LIVE LOAD)

Top Radius R _t Ft.	Wall Thickness (Inches)					
	0.111 (12 Ga.)	0.140 (10 Ga.)	0.170 or 0.188 (8 or 7 Ga.)	0.218 (5 Ga.)	0.249 (3 Ga.)	0.280 (1 Ga.)
15'	2.5'	2.5'	2.5'	2.0'	2.0'	2.0'
15'-17'		3.0'	3.0'	2.5'	2.0'	2.0'
17'-20'			3.0'	2.5'	2.5'	2.5'
20'-23'				3.0'	3.0'	3.0'
23'-25'					4.0'	4.0'

For additional information regarding this table, refer to notes on page 81. Contact a Contech representative for Pear and Pear-Arch shapes.

BridgeCor® Design

The design procedure for BridgeCor is outlined in AASHTO LRFD Section 12.8.9 - Deep Corrugated Structural Plate Structures. These structures are designed as long-span culverts but must also meet provisions for flexure and general buckling. BridgeCor structures can be made in multiple shapes and sizes to meet site specific project requirements.

Structures designed under this specification must be analyzed by accepted finite element analysis. This analysis must consider the type of soils and loads applied to the system to determine the thrust, bending and stiffness parameters of the structural plate.

These shapes include:

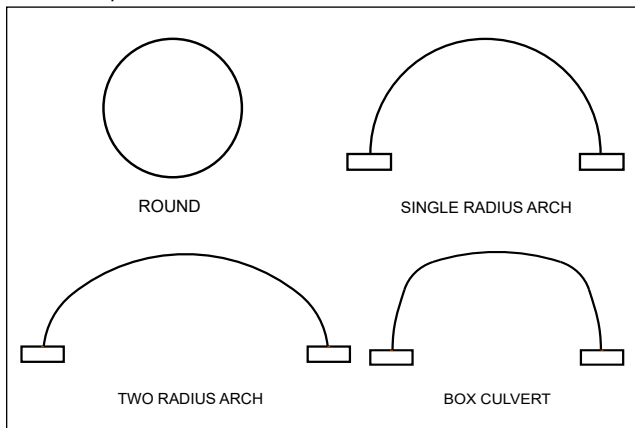

Custom shapes are available upon request.

To properly analyze these parameters using finite element analysis it is important to have a geotechnical report for each specific bridge location. This information will allow the designer to optimize both the gage of the steel and the limits of the structural backfill adjacent to the BridgeCor structure.

This design procedure is more comprehensive than a typical ring compression design for MULTI-PLATE structures. Therefore, it will require additional effort to properly evaluate a BridgeCor solution for any application. This additional planning is critical to a successful project.

BridgeCor Monitoring

Due to the potential large sizes of BridgeCor structures and the information outlined in AASHTO Specification Section 26 – Metal Culverts, it is a requirement to monitor the shape of the structure during the backfill process. Depending on the size and complexity of a structure, guidelines have been established to determine what level of monitoring will be required on all projects. There are four levels of monitoring outlined for BridgeCor. These levels range from a preconstruction meeting with a contractor to a full monitoring program similar to the process outlined for a SUPER-SPAN structure. Contact your local Contech representative for additional information.

Minimum Cover Over Plate Structures

Establishing minimum cover over plate structure is one of the most important factors in ensuring the successful installation of soil-corrugated metal interaction structures. Properly compacted soil around and over the structure plays an important part in distributing the load that reaches the structure. Without minimum cover, loads applied by vehicles can result in unacceptable structure deformation.

Contech Engineered Solutions publishes suggested minimum height of cover tables in each following section. When highway type loads are expected, minimum height of cover over steel or aluminum structural plate (excluding SUPER-SPAN or Aluminum Box Culvert structures) amounts to one eighth of the span or diameter of the structure with a minimum of 12" in all cases. In some cases, a reinforced concrete load-relieving slab may be used when minimum cover is not achievable.

With the combination of a plate and rib, minimum cover over Aluminum Box Culverts is often lower than for standard plate structures. The required minimum and maximum cover are limited to the values indicated in Tables 48A, 48B, 49A and 49B. They are based on the live load classification and assuming the proper reinforcing rib and plate gage combinations shown in the height of cover tables for Aluminum Box Culverts.

Minimum cover over SUPER-SPAN structures is dependent upon the top radius of the structure. Minimum cover may be determined from Table 9 on the previous page.

Minimum cover is measured from the top of the structure to the bottom of a flexible pavement and to the top of a rigid pavement. Particular attention should be given to the height of cover near roadway shoulders as they slope away from the road crown. Minimum cover heights must be maintained throughout the life of the structure. Gravel (unpaved) roads can be mistakenly graded below the minimum cover height resulting in unacceptable loading conditions. **It is recommended that unpaved roads incorporate at least 6" more than the minimum allowable cover depth to allow for rutting.**

It should be understood that often the greatest live load applied to the structure may be the load applied by construction equipment. Refer to page 20 for additional information and guidance regarding required minimum cover for construction equipment and other heavy vehicle loads. Off-highway live loads such as mine haul trucks should be evaluated carefully. Contech can assist the designer with establishing minimum cover for this type of loading condition.

Minimum Cover for Heavy Off-Road Construction Equipment

Operating heavy construction equipment over or adjacent to flexible structure installations will likely require additional protection for the structure compared to that provided by the required minimum cover heights for normal highway traffic. Therefore, for temporary construction vehicle loads, additional compacted cover may be required over the top of the pipe structure to help balance loads and dissipate the effects of these larger live loads. The contractor is responsible for providing adequate minimum cover to avoid damage and/or distortion to the metal structure.

The actual minimum cover heights required for heavier construction vehicle live loads will vary based on the anticipated construction equipment (size, weight and axle loads). Other factors influencing the minimum cover height requirements are structure size, shape and gage combined with local site conditions. These factors need to be addressed by the engineer and/or contractor prior to the start of construction.

As a general guideline, an adequate amount of minimum cover can be achieved by providing approximately twice the depth of fill material required for highway traffic. This temporary cover is to consist of a quality fill such as an A-1, A-2-4, A-2-5, or A-3 material per AASHTO M 145 and is to be placed in a controlled and balanced manner over the pipe structure and compacted to a minimum 90% density per AASHTO T-180.

The cover depth required for protection from construction equipment loads is measured from the crown of the structure to the top of the maintained construction roadway surface. Additionally, the roadway surface for the construction loading and vehicular traffic conditions shall be well-maintained and free of ruts for the duration of the temporary vehicle crossings. Contact your local Contech representative for additional information.

Aluminum Box Culverts

The addition of temporary soil cover for heavy construction loads is not feasible or permissible for Aluminum Box Culvert structures. By design, these structures are limited in the range of permissible fill heights and live loads. Contact your local Contech representative with questions about permissible live loads and allowable soil cover heights (minimum and maximum) for Aluminum Box Culverts.

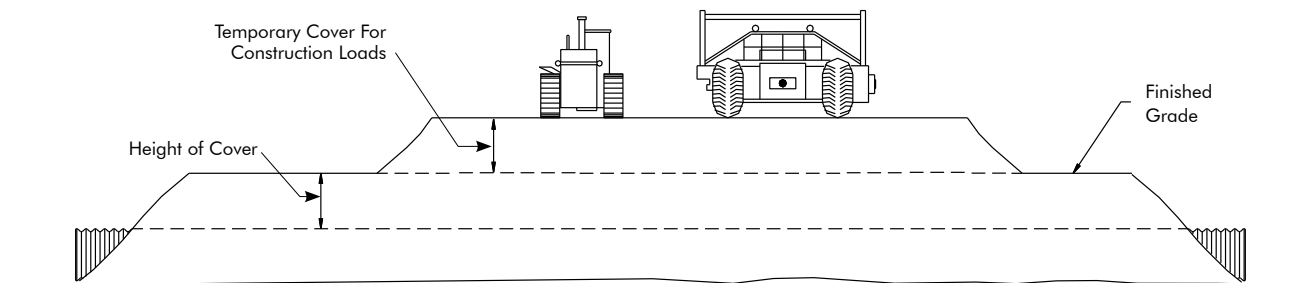

Notes:

1. The contractor is responsible for providing adequate minimum cover to avoid damage and/or distortion to the metal structure.
2. Minimum cover will vary based on local site conditions. Requirements shall be based on the structure shape and size, material gage and anticipated construction equipment (size, weight, and axle loads).
3. Temporary protection from construction equipment loads is measured from the crown of the structure to the top of the maintained construction roadway surface.



Multi-Barrel Installation

Structure End Treatments

Once the designer has selected a structure, it is important to design for the proper structure end treatment. Hydraulic efficiency, protection of the structure backfill and foundation materials, and structure alignment may dictate the usage of modified structure ends (bevels and skews), headwalls, or cut-off walls. For any metal structure end treatment, a headwall and/or toe-wall may be necessary to prevent inlet flotation.

When structures with full inverts are used, the designer should always consider a concrete or metal toewall to anchor the leading edge of the invert, thus minimizing the possibility of hydraulic uplift forces lifting the invert of the structure. The range of possible end treatments include but are not limited to:

Projecting Square End Structures

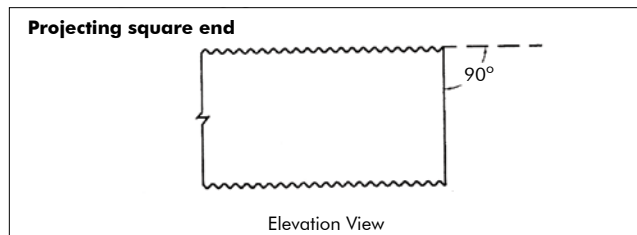

Projecting square end structures are generally the most cost-effective end treatment option. The square end must project from sloping side fill enough to allow the invert to meet the toe of the slope. All structures can be supplied with projecting square ends.

Full-Beveled Ends

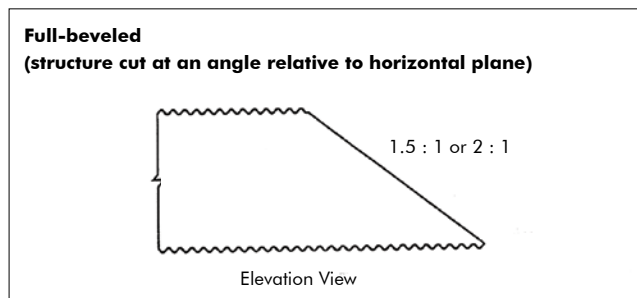

Full-beveled ends are used to match the side slope of an embankment with no exposed protruding metal, to improve the overall structure aesthetics. In addition, full bevels can provide an improved hydraulic entrance efficiency when compared to square-ended structures.

All beveled cuts should be limited to a range of 1.5:1 to 2:1 slopes. A beveled section is comprised of incomplete rings of plates acting as a thin metal retaining wall system. Therefore, beveled ends must be side supported during backfill process and may require a reinforced concrete slope collar to help stabilize the beveled end of the structure from erosion and excessive deflection.

Full-beveled ends are not recommended for pipe-arch and underpass shapes.

Step-Beveled Ends

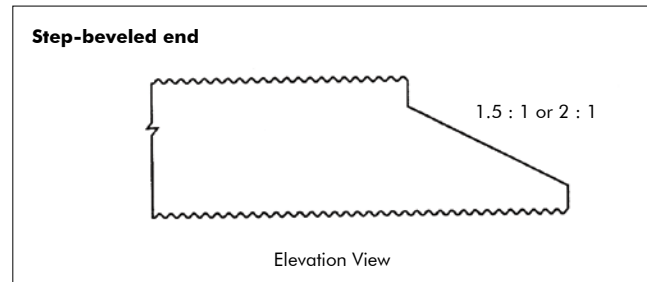

Step-beveled ends minimize the number of cut or incomplete plate rings while still providing a sloped end. This option stiffens the invert and crown of the structure minimizing the overall structure deflection during the backfill process. For this reason, step-beveled ends are more desirable over fully beveled ends.

Recommended step-bevel dimensions are:

- **Round**

Top step = Bottom step

(minimum of 6" to 0.25 x structure diameter per step)

- **Pipe-Arch and Underpass**

The top step should be a minimum of 6" to 0.25 x structure rise and the bottom step dimensions should be at the transition of the haunch and top radii.

- **Horizontal and Vertical Ellipses**

Top step = Bottom step

(minimum of 6" to 0.25 x structure rise per step)

The steps should be at the transition of the sides and top and/or bottom radii.

- **Arches**

The top step of 0.25 x rise and the bottom step (minimum of 6") are recommended for arch structures.

- **Aluminum Box Culverts**

Step-beveled and full-beveled ends are not utilized.



MULTI-PLATE® with Step-Beveled End and Concrete Collar

Skewed Ends

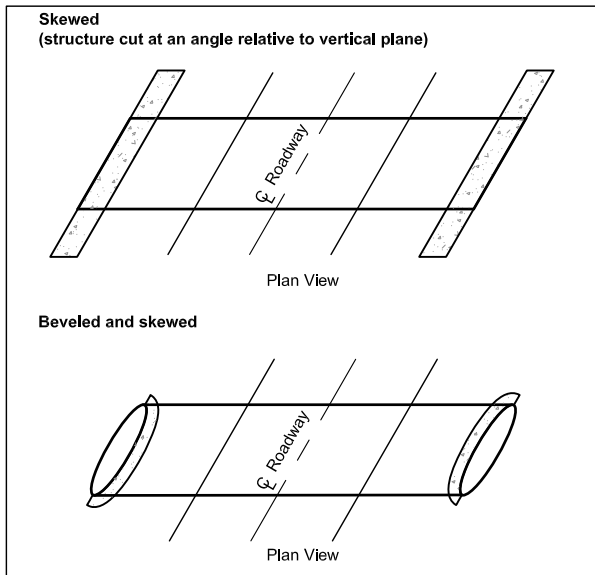

Skewed ends allow the designer to match the skew of the structure to the roadway alignment. As with beveled ends, skewed ends are less stable because of incomplete plate rings. Unbalanced soil loads on the structure ends can cause unwanted deflection of the extended end of the structure.

A reinforced concrete headwall or collar must be designed for all skew angles. More commonly, the structure end will be skewed in combination with a beveled end (skewed to the roadway and beveled to match the side slope.) Consult your Contech representative for exact dimensions and a specific plate layout.

The engineer/designer is encouraged to consider “warping” the side slope fill to balance soil loads on each side of the structure (see drawing on page 26).



BridgeCor Arch with Full-Beveled Ends and Slope Collar

Cast-in-place (C.I.P.)

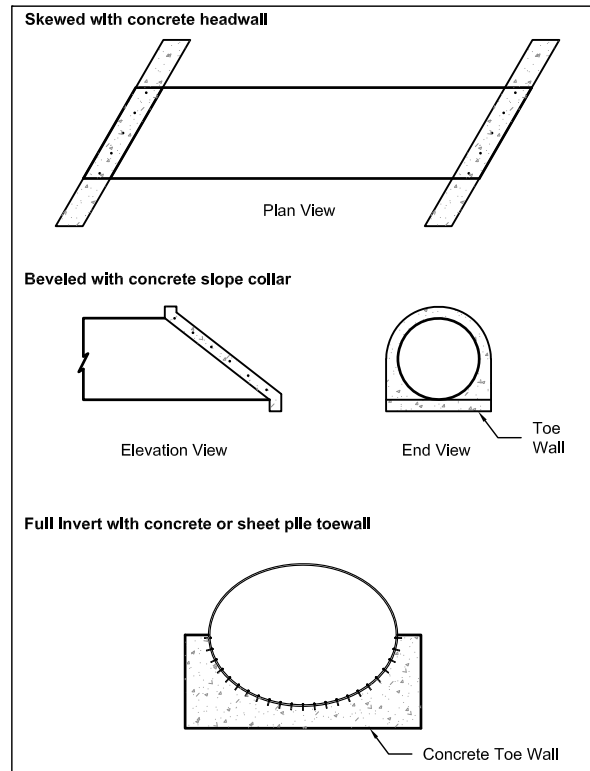

C.I.P. concrete headwalls or collars are recommended for the following:

- Improved hydraulic efficiency
- Potential sustained high flows
- Skewed ends on structures

By installing a concrete headwall/collar, the structure becomes more stable and minimizes excessive movement.

C.I.P. concrete headwalls are secured to the plate structure by the use of anchor bolts placed circumferentially at the end of the structure. Anchor bolts may either be straight 3/4" diameter or “hook” bolts. The circumferential spacing and the choice of bolt type is the responsibility of the designer of headwall. Typical headwall details are shown on the following pages. CAD details are available on request from a Contech representative.

C.I.P. Concrete slope collars placed around a beveled end structure guard against deflection of end plates, provide erosion erosion, minimize backfill loss, and provide an aesthetic end treatment. They are anchored to the structure by the use of anchor bolts as with concrete headwalls.

C.I.P. Concrete Cut-off or Toewalls should be considered on every hydraulic structure with an invert. Undercutting on the inlet end can lead to loss of backfill, piping of water around the exterior of the structure, and undesirable uplift forces that can damage the structure. It is the responsibility of the engineer to determine the appropriate depth of the toewall to protect the invert bedding. Slope protection is also advised to preclude water entering the structure backfill.

Aluminum Box Culverts with full inverts are provided with a bolt-on 27" deep aluminum toewall plate. The designer must determine the proper depth of the toewall for the structure's invert protection.

Protection from Hydraulic Forces

Contech Engineered Solutions advises the designer to take all necessary precautions to protect the ends of corrugated metal hydraulic structures. Damage to the structure ends may result from inlet blockage. The designer is also advised that whenever heavy debris flow is expected, the use of a large single span structure is recommended over smaller, multiple structures.

Appropriate end treatment design is beyond the scope of this design guide. Additional information can be obtained from the local DOT guidelines, the FHWA Circular Memo, "Plans for Culvert Inlet and Outlet Structures" and chapters within the NCSPPA Corrugated Steel Pipe (CSP) Design Manual.

Modular Block Headwalls

Modular Block Headwalls can be utilized to provide an aesthetically pleasing end treatment. If the structure is expected to be subjected to hydraulic forces, special consideration must be given to the possible loss of backfill through the block wall face and at the junction of the blocks with the structure. Geotextile fabrics placed in critical areas can minimize the loss of fill.

The designer should also consider other factors such as but not limited to:

- Scouring forces acting on the footing of the wall.
- Rapid draw-down forces that can occur if the backfill becomes saturated.
- Settlement of the structure relative to the wall. Settlement joints may be necessary.

Please refer to the details on the next page and contact your Contech representative for more details on modular block headwall information.

BridgeCor, SUPER-SPAN and SUPER-PLATE End Treatments

Any of the previously mentioned headwall options can be used with these structures.



BridgeCor with Bolt-A-Plate® Metal Wall End Treatments

Metal Wall End Treatments

Aluminum Structural Plate and Aluminum Box Culverts can be supplied with a pre-designed corrugated aluminum headwall and wingwall system. The typical application for metal headwalls is for projecting square ended (non-skew cut) structures. See the Aluminum Box Culvert section starting on page 62 for details.

Alternative steel headwalls and wingwalls (e.g. Metric Sheeting or 6x2 Bolt-A-Plate®) can be considered on a project-by-project basis. Contact your local Contech representative.

Welded Wire Wall System

The Contech Wire Wall System utilizes black or galvanized wire facing baskets in conjunction with geogrid reinforcement to create a gravity wall system for use in permanent and temporary wall applications. The combination of a flexible wire wall system adjacent to a flexible pipe system makes an ideal end treatment solution for Contech products, especially in areas where differential settlement may occur.



BridgeCor with Welded Wire Wall System

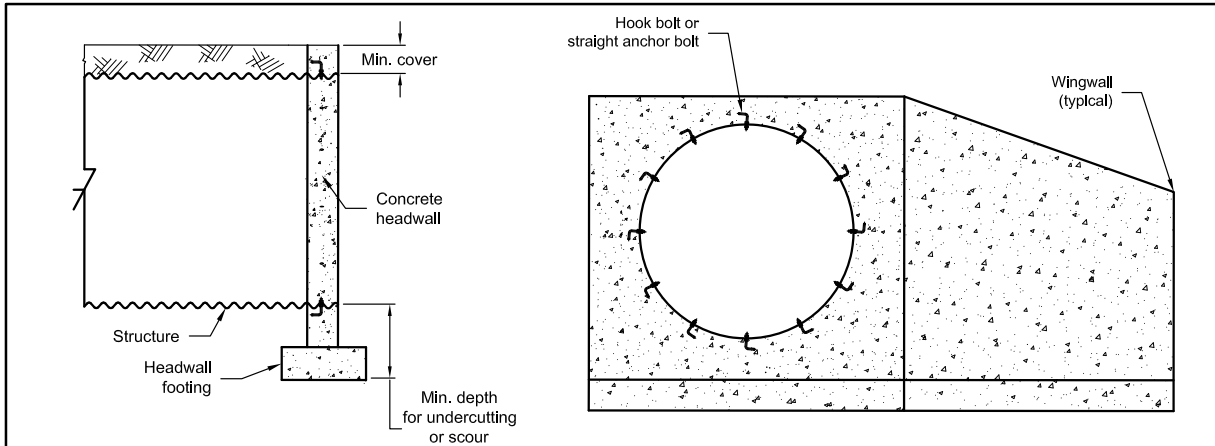

Typical Headwall Detail

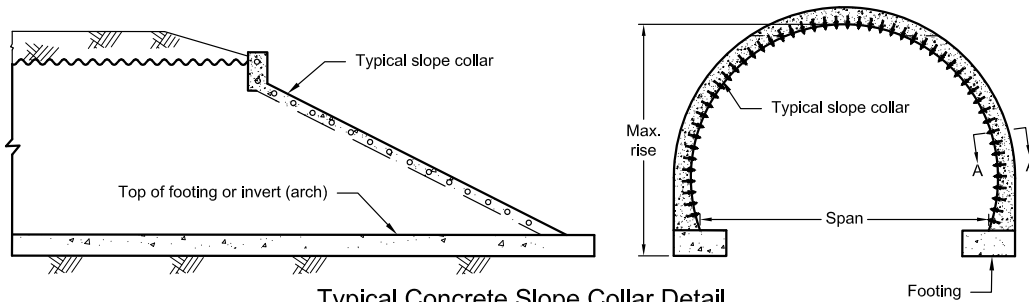

Typical Concrete Slope Collar Detail

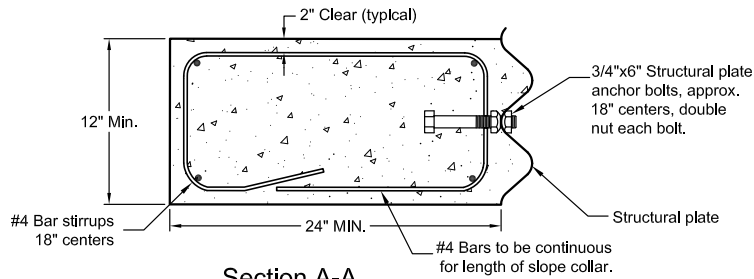

Section A-A

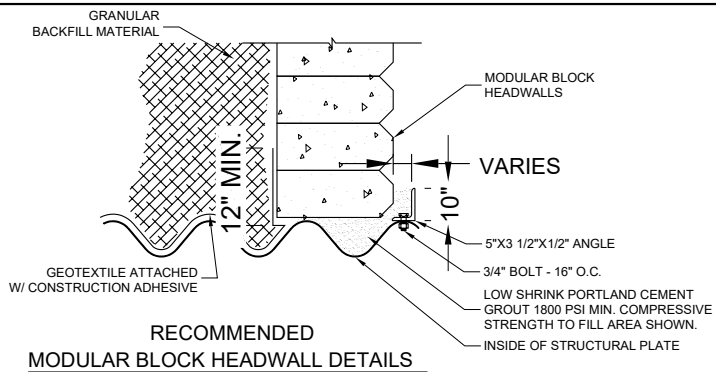

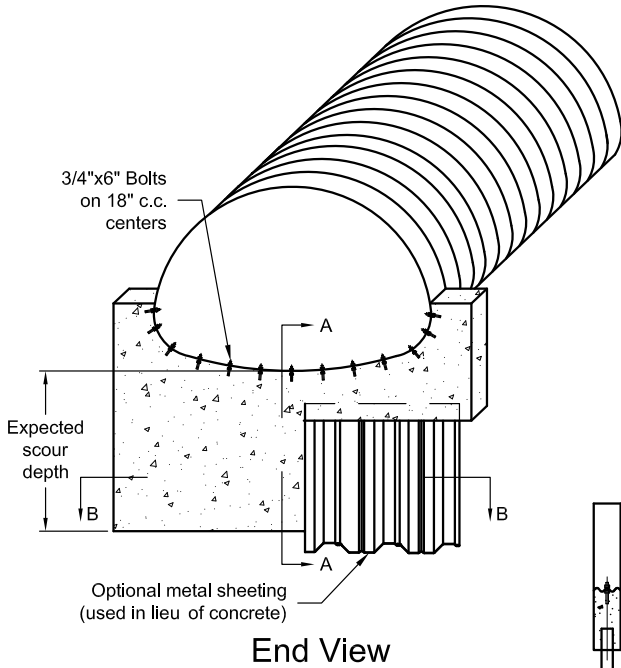

End View

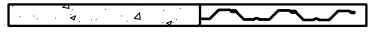

Section B-B

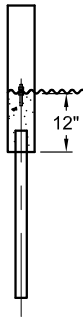

Sec. A-A

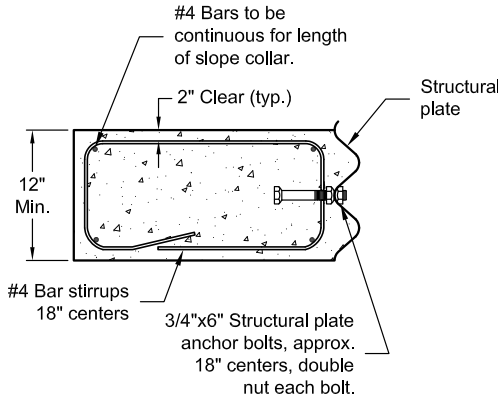

Slope Collar Cross Section

Notes:
 This detail shows minimum dimensions recommended for structural soundness.
 Certain hydraulic conditions may require a larger slope collar or other end treatment.

Notes:
 1. The contractor may need to brace or otherwise support the cut end during backfill operations.
 2. Step dimension varies with shape and diameter. See page 21 for additional details.

Standard Bevels

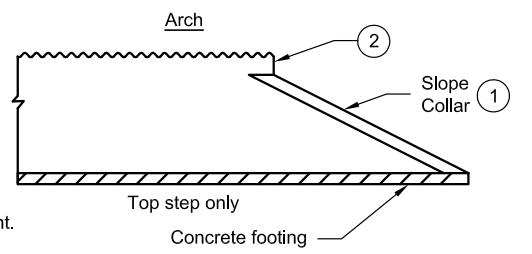
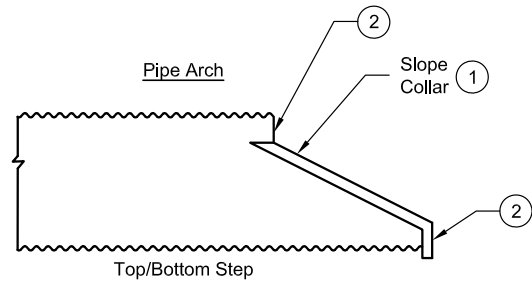
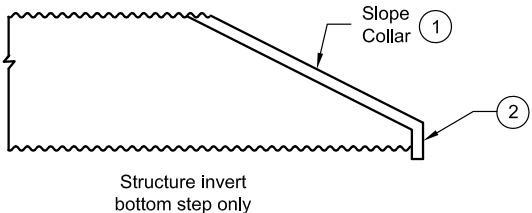
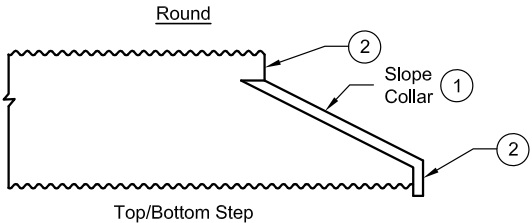

STRUCTURAL PLATE BEVELS & CUT OFF WALL

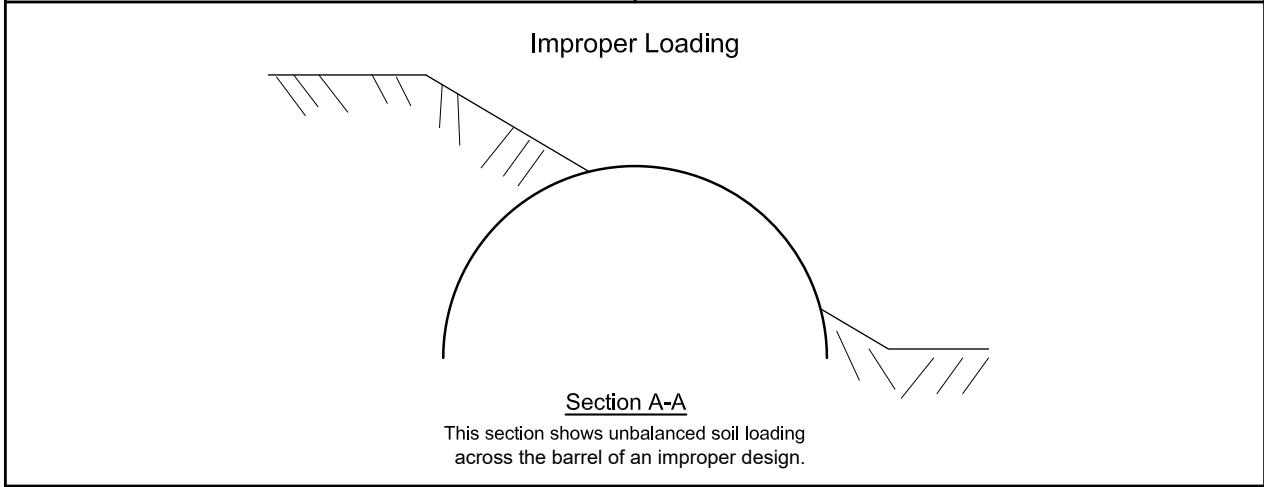
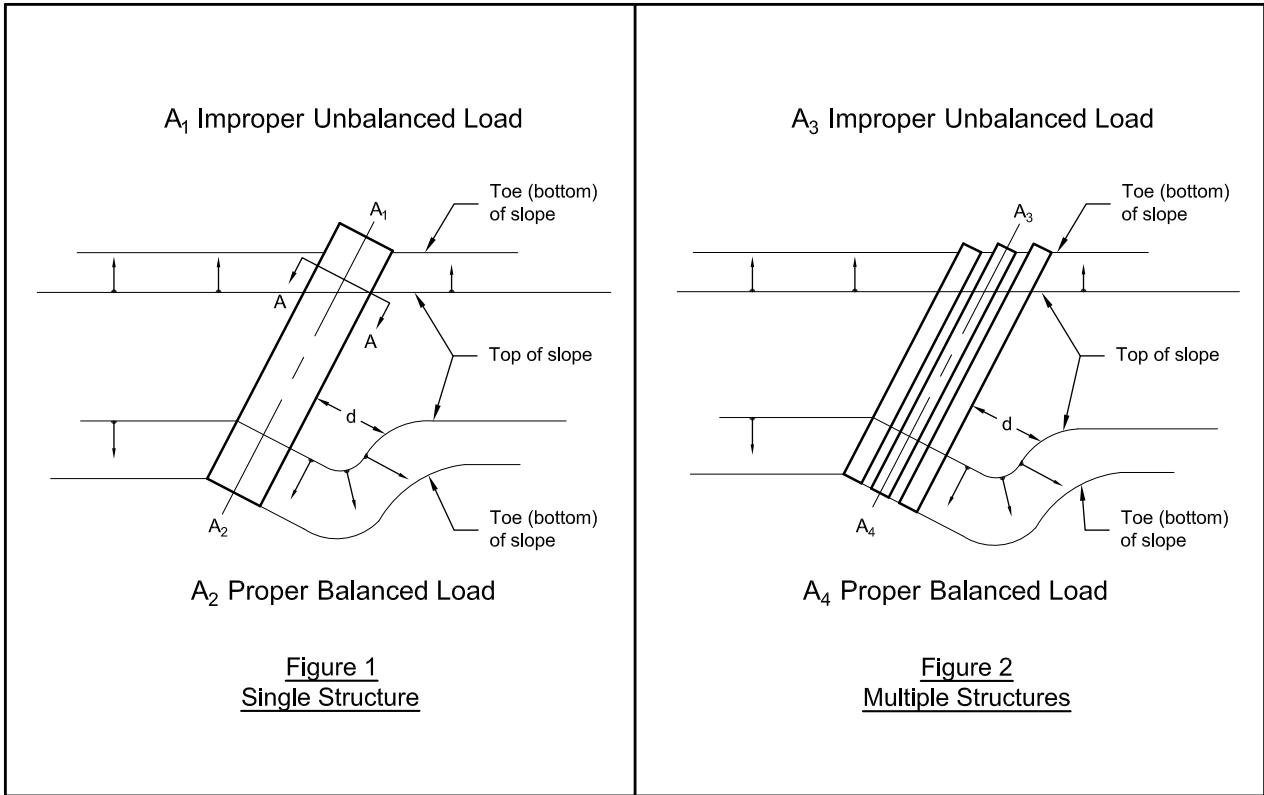

- Notes:**
1. $d \geq 1.5$ (Pipe rise + Pipe cover)
 2. Figure 1 - (Single Structure)
 - A₁ - Improper Balance
 - A₂ - Proper Balance (Warped Fill)
 3. Figure 2 - (Multiple Structures)
 - A₃ - Improper balance and end stagger.
 - A₄ - Proper balance and uniform (Squared off) ends (warped fill).



**CORRUGATED STRUCTURES
SKEWED TO FILL SLOPE**

Material, Design & Installation Specifications

The following is an outline of applicable AASHTO and ASTM specifications. Additional specifications are available from the American Railroad Engineers and Maintenance of Way Association (AREMA), Manual for Railway Engineering for railroad projects. For additional assembly and installation guidelines, refer to the National Corrugated Steel Pipe Association (NCSPA). The Contech Structural Plate Design Guide is based on the general requirements of AASHTO LRFD Design Specification.

TABLE 10. MATERIAL, DESIGN & INSTALLATION SPECIFICATIONS		
DESCRIPTION	AASHTO	ASTM
MULTI-PLATE®		
Material	M 167 – Standard Specification for Corrugated Steel Structural Plate	A761
Installation	Refer to AASHTO LRFD Bridge Construction Specifications (Sec. 26)	A807
Design	Refer to AASHTO Standard Specifications for Highway Bridges (Sec. 26)	A796
	Refer to AASHTO LRFD Bridge Design Specifications (Sec. 12)	
Optional Polymer Coating*	N/A	A1113
Aluminum Structural Plate		
Material	M 219 – Standard Specification for Corrugated Aluminum Structural Plate	B746
Installation	Refer to AASHTO LRFD Bridge Construction Specifications (Sec. 26)	B789
	Refer to AASHTO Standard Specifications for Highway Bridges (Sec. 26)	
Design	Refer to AASHTO LRFD Bridge Design Specifications (Sec. 12)	B790
	Refer to AASHTO Standard Specifications for Highway Bridges (Sec. 12.6)	
Aluminum Box Culverts		
Material	M 219 – Standard Specification for Corrugated Aluminum Structural Plate	B864
Installation	Refer to AASHTO LRFD Bridge Construction Specifications (Sec. 26)	N/A
	Refer to AASHTO Standard Specifications for Highway Bridges (Sec. 12.8)	
Design	Refer to AASHTO LRFD Bridge Design Specifications (Sec. 12)	N/A
	Refer to AASHTO Standard Specifications for Highway Bridges (Sec. 12.8)	
SUPER-SPAN™		
Material	M 167 – Standard Specification for Corrugated Steel Structural Plate	A761
Installation	Refer to AASHTO LRFD Bridge Construction Specifications (Sec. 26)	A807
	Refer to AASHTO Standard Specifications for Highway Bridges (Sec. 12 and Sec. 26)	
Design	Refer to AASHTO LRFD Bridge Design Specifications (Sec. 12)	N/A
	Refer to AASHTO Standard Specifications for Highway Bridges (Sec. 12.7)	
Optional Polymer Coating*	N/A	A1113
SUPER-PLATE®		
Material	M 219 – Standard Specification for Corrugated Aluminum Structural Plate	A761
Installation	Refer to AASHTO LRFD Bridge Construction Specifications (Sec. 26)	B789
	Refer to AASHTO Standard Specifications for Highway Bridges (Sec. 12 and Sec. 26)	
Design	Refer to AASHTO LRFD Bridge Design Specifications (Sec. 12)	N/A
	Refer to AASHTO Standard Specifications for Highway Bridges (Sec. 12.7)	
BridgeCor®		
Material	M 167 – Standard Specification for Corrugated Steel Structural Plate	A761
Installation	Refer to AASHTO LRFD Bridge Construction Specifications (Sec. 26)	A807
Design	Refer to AASHTO LRFD Bridge Design Specifications (Sec. 12.8.9)	N/A
Optional Polymer Coating*	N/A	A1113

Complete copies of these specifications are available from AASHTO & ASTM.

Excerpts of these specifications are available from Contech Engineered Solutions LLC.

* For polymer-coated plates, the galvanized fasteners will be specially treated with an applicable polymer or aluminum coating.

MULTI-PLATE®

Made to Perform, Built to Last.

Since 1931, Contech MULTI-PLATE structures have provided designers of underpasses and bridges with a versatile method of construction as well as strength, durability, and economy. A variety of shapes and sizes ensures that MULTI-PLATE structures fit most applications. Ease of design, construction, and proven reliability make them the frequent choice of experienced engineers.

MULTI-PLATE structures are made from sturdy, heavy gage, corrugated steel plates that are pre-formed to various shapes and sizes, then galvanized for long-term protection and performance. The plates are delivered to the job site and bolted together to form a MULTI-PLATE structure optimally suited for the project.

MULTI-PLATE is available in round, vertical ellipse, underpass, pipe-arch, horizontal ellipse, and single radius arch shapes — all in a wide range of sizes.

Superior Durability

MULTI-PLATE's heavy gage steel uses an industry standard 3 oz. per square foot galvanized coating (both sides) capable of providing a service life of 75 years or longer. For additional information, see page 7.

When selecting the proper material for an application, designers need to evaluate the soil side of the structure along with the corrosive and abrasive action due to the flow at the invert of the structure. The use of structural plate gives designers more structure shape options to help minimize the impact of abrasion on the invert of the structure.

High Load-Carrying Capacity

As a soil-structure interaction system, MULTI-PLATE is designed to carry high combined live and dead loads. High traffic loads and deep cover applications are key benefits of specifying MULTI-PLATE.

A More Efficient Installation

Prefabricated plates are assembled in the field, translating into finished construction in days instead of weeks as with most concrete structures.

Versatility

MULTI-PLATE structures offer a wide variety of shape and size options, which may provide the most cost effective solution to the site requirements.

Descriptions of Plates

MULTI-PLATE corrugations of 6-inch pitch and 2-inch depth are perpendicular to the length of each plate.

Thickness. Standard specified thickness of the galvanized plates vary from 0.111 inches (12 gage) to 0.380 inches (3/8").

Widths. Standard plates are fabricated in five widths. See Table 11.

The "Pi" nomenclature ($\text{Pi} = 3.2$) translates circumference directly into nominal diameter in inches. For example, four 15-Pi plates give a diameter of 60 inches (60-Pi); four 21-Pi plates provide a diameter of 84 inches (84-Pi), etc. Various plate widths may be combined to obtain almost any diameter.

Lengths. MULTI-PLATE plates are furnished in either 10-foot or 12-foot net lengths. Overall length of the square-end structure is about four inches longer than its net length because a 2-inch lip protrudes beyond each end of every plate for lapping purposes.

Longitudinal bolt holes. The plates are punched with 7/8" diameter holes on 3" centers to provide the standard four bolts per foot of longitudinal seam in two staggered rows on 2" centers. They may also be punched to provide either six or eight bolts per foot of longitudinal seam on 0.280 inch (1 gage) thickness material, if required. 1" diameter holes, punched 8 bolts per foot of longitudinal seam are used for 0.318 (5/16") and 0.380 (3/8") thick material.

Circumferential bolt holes. The inside crests of the end corrugations are punched with 1" diameter holes for circumferential seams on centers of 9.6 inches or $9 \frac{19}{32}$ inches (equals 3-Pi).

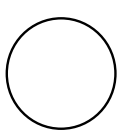

Round

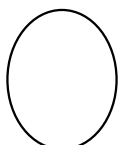

Vertical Ellipse

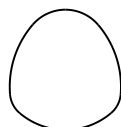

Underpass



Pipe-Arch

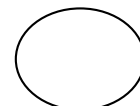

Horizontal Ellipse



Single Radius Arch

Standard Shapes

Standard Plate Detail

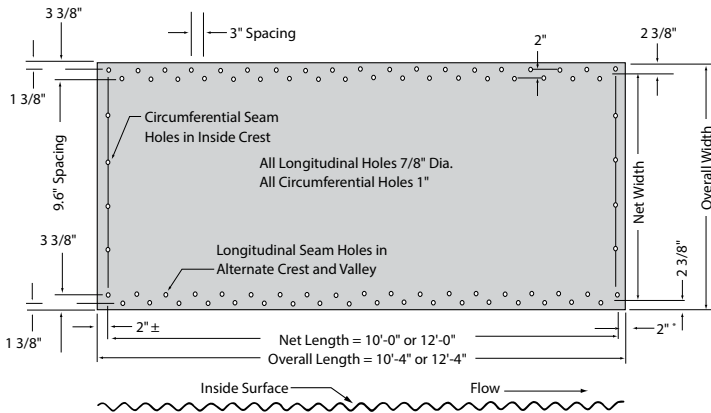

- Notes:
1. For square-end structures on which headwalls are to be built, design should allow for a 2" lip at each end of the structure.
 2. A 4-bolt per foot pattern is detailed above.

TABLE 11. DETAILS OF UNCURVED MULTI-PLATE® SECTIONS

Net Width (Inches)		Overall Width (Inches)	Spaces (9.6 Inches)	Number of Circumferential Bolt Holes
Nominal Detail				
9 Pi	28.8	28 13/16	33 9/16	4
15 Pi	48.0	48	52 3/4	6
18 Pi	57.6	57 5/8	62 3/8	7
21 Pi	67.2	67 3/16	71 15/16	8
24 Pi	76.8	76 13/16	81 9/16	9

For MULTI-PLATE, Pi = 3.2

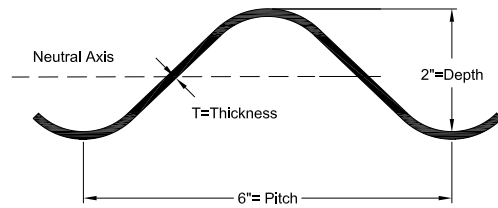

Standard 6" x 2" Corrugation

TABLE 12. APPROXIMATE WEIGHT OF MULTI-PLATE SECTIONS

Pi	Net Length (Feet)	Gage Thickness, T (Inches)								
		Galvanized, in Pounds, without Fasteners								
		12 (0.111)	10 (0.140)	8 (0.170)	7 (0.188)	5 (0.218)	3 (0.249)	1 (0.280)	5/16 (0.318)	3/8 (0.380)
9	10	161	205	250	272	316	361	405	460	545
9	12	193	246	299	325	379	432	485	551	653
15	10	253	323	393	428	498	568	638	725	859
15	12	303	386	470	511	595	678	762	865	1026
18	10	299	382	465	506	589	671	754	856	1015
18	12	357	456	555	604	703	801	900	1022	1212
21	10	345	441	536	583	679	774	869	987	1170
21	12	412	526	640	697	810	924	1038	1179	1398
24	10	396	504	613	667	775	886	995	N/A	N/A
24	12	473	603	732	797	927	1060	1190	N/A	N/A

- Notes:
1. Weights are based on a zinc coating of 3 oz./sq. ft., total both surfaces.
 2. All weights are subject to manufacturing tolerances.
 3. Specified thickness is a nominal galvanized thickness. Reference AASHTO M 167.
 4. Gages 12 through 1 use 3/4" diameter bolts. 5/16 and 3/8 use 7/8" diameter bolts.

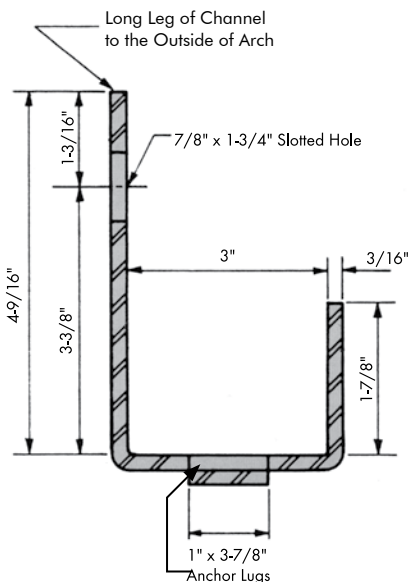

Unbalanced Channel Cross Section

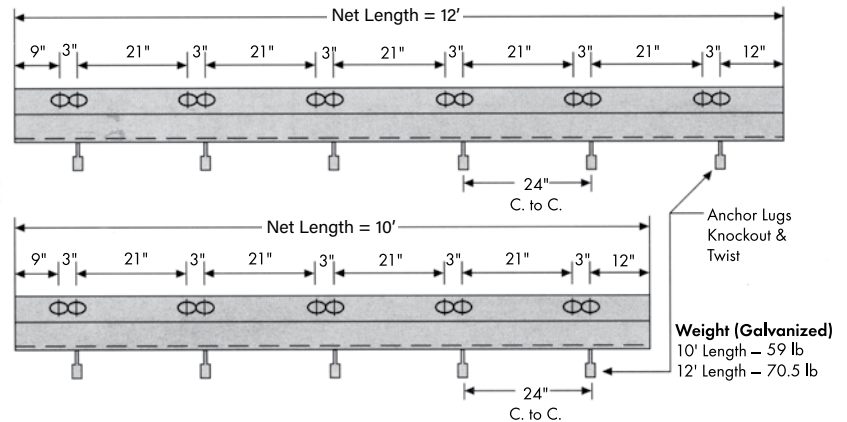

Unbalanced Channel for MULTI-PLATE® Arch

MULTI-PLATE® Bolts and Nuts

3/4" or 7/8" diameter hot-dipped galvanized steel (specially heat-treated) bolts meeting ASTM A449 specifications (with suitable nuts) are used to assemble structural plate structures.

The underside of the bolt head is uniformly rounded and ribbed to prevent bolt head rotation while tightening. Unlike conventional bolts, once the nut is finger tight, final tightening can typically be accomplished by one worker with an air driven impact wrench to 100 – 300 ft.-lbs. of torque.

In addition, one side of the nut is spherically formed to help align and center the fastener into the punched holes. The rounded side shall be placed against the structure.

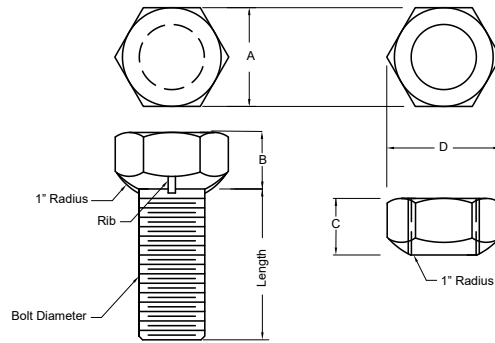

Bolt and Nut

TABLE 13. BOLT LENGTH AND USAGE

Plate Gages	Bolt Lengths	Bolt Diameter
12, 10 and 8	1 1/4" and 1 1/2"	3/4"
7 and 5	1 1/2" and 1 3/4"	3/4"
3 and 1	1 1/2" and 2"	3/4"
5/16 and 3/8	2" and 2 1/2"	7/8"

Notes:

1. The longer bolts are used in 3 plate lap seams.
2. For asphalt coated plates, bolts are 1/4" longer.
3. Service bolts (3" long) are provided to assist with assembly.

TABLE 14. TYPICAL BOLT AND NUT

Diameter (Inches)	A (Inches)	B (Inches)	C (Inches)
3/4	1 1/4	9/16	13/16
7/8	1 7/16	3/4	7/8

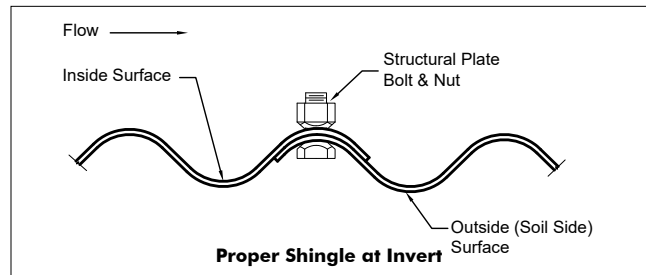

MULTI-PLATE® Round

TABLE 15. MULTI-PLATE ROUND PIPE

Diameter		End Area (Sq. Ft.)	Diameter		End Area (Sq. Ft.)
(Ft.-In.)	(Inches)		(Ft.-In.)	(Inches)	
5-0	60	19.1	16-0	192	204.4
5-6	66	23.2	16-6	198	217.5
6-0	72	27.8	17-0	204	231.0
6-6	78	32.7	17-6	210	244.9
7-0	84	38.1	18-0	216	259.2
7-6	90	43.9	18-6	222	274.0
8-0	96	50.0	19-0	228	289.1
8-6	102	56.6	19-6	234	304.7
9-0	108	63.6	20-0	240	320.6
9-6	114	71.0	20-6	246	337.0
10-0	120	78.8	21-0	252	353.8
10-6	126	87.1	21-6	258	371.0
11-0	132	95.7	22-0	264	388.6
11-6	138	104.7	22-6	270	406.6
12-0	144	114.2	23-0	276	425.0
12-6	150	124.0	23-6	282	443.8
13-0	156	134.3	24-0	288	463.0
13-6	162	144.9	24-6	294	482.6
14-0	168	156.0	25-0	300	502.7
14-6	174	167.5	25-6	306	523.1
15-0	180	179.4	26-0	312	543.9
15-6	186	191.7			

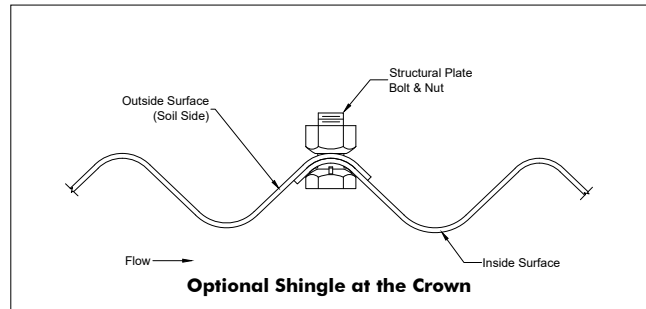

Note: The nut may be placed on either side of the plate.

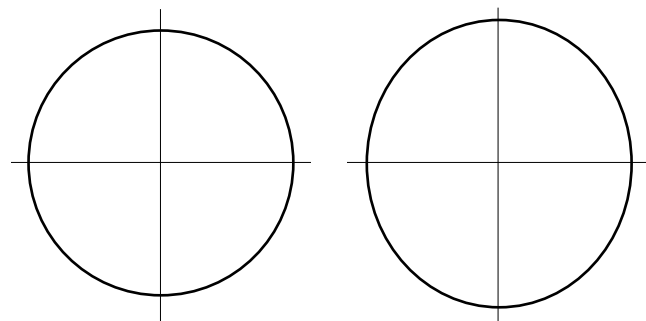

Round and 5% Vertical Ellipse Pipe

TABLE 16. MULTI-PLATE ROUND PIPE

WEIGHT TABLES														
Diameter (Ft.-In.)	Gage Thickness (Inches) Weight Shown as Pounds per Foot of Structure									Plate Make-Up (see Note 6)				Total Plates
	12 (0.111)	10 (0.140)	8 (0.170)	7 (0.188)	5 (0.218)	3 (0.249)	1 (0.280)	5/16 (0.318)	3/8 (0.380)	Pi				
	15	18	21	24										
5-0	110	138	166	180	208	236	264	310	376	4				4
5-6	119	150	180	196	227	257	287	336	407	2	2			4
6-0	129	162	195	212	245	277	310	362	439		4			4
6-6	138	174	209	227	263	298	333	387	471		2	2		4
7-0	147	185	223	243	281	318	356	413	502			4		4
7-6	157	198	239	260	300	341	382	465	563			2	2	4
8-0	168	211	254	276	320	364	407	491	595				4	4
8-6	184	231	278	302	349	395	442	516	627	2	4			6
9-0	193	242	292	317	367	416	465	542	659		6			6
9-6	202	254	306	333	385	436	488	568	690		4	2		6
10-0	212	266	321	349	403	457	512	594	722		2	4		6
10-6	221	278	335	364	421	478	535	619	754			6		6
11-0	231	291	350	381	440	500	560	671	815			4	2	6
11-6	241	304	366	398	460	523	585	697	847			2	4	6
12-0	251	316	381	415	479	546	611	723	878				6	6
12-6	267	335	404	439	507	575	644	749	910		6	2		8
13-0	276	347	418	454	525	596	667	774	942		4	4		8
13-6	285	359	432	470	543	616	690	800	973		2	6		8
14-0	295	371	447	485	561	637	713	826	1005			8		8
14-6	305	384	462	502	581	660	738	878	1066			6	2	8
15-0	315	396	478	519	600	682	764	904	1098			4	4	8
15-6	325	409	493	536	620	705	789	929	1130			2	6	8
16-0		422	508	553	639	728	814	955	1161				8	8
16-6		440	530	576	666	755	845	981	1193		4	6		10
17-0		452	544	591	684	776	868	1006	1224		2	8		10
17-6		464	559	607	701	796	891	1032	1256			10		10
18-0			574	624	721	819	917	1085	1318			8	2	10
18-6			589	640	741	841	942	1110	1349			6	4	10
19-0			605	657	760	864	967	1136	1381			4	6	10
19-6			620	674	780	887	993	1161	1412			2	8	10
20-0				691	799	909	1018	1187	1444				10	10
20-6				713	824	935	1046	1213	1476		2	10		12
21-0				728	842	955	1069	1238	1507			12		12
21-6					861	978	1095	1291	1569			10	2	12
22-0					881	1001	1120	1316	1600			8	4	12
22-6					900	1023	1145	1342	1632			6	6	12
23-0						1046	1171	1368	1664			4	8	12
23-6						1069	1196	1393	1695			2	10	12
24-0						1091	1222	1419	1727				12	12
24-6							1248	1446	1758			14		14
25-0							1273	1497	1820			12	2	14
25-6							1298	1523	1852			10	4	14
26-0								1548	1883		8	8		16

Notes:

1. Dimensions are to inside crests of corrugations and are subject to manufacturing tolerances.
2. These plate arrangements will be furnished unless noted otherwise on assembly drawings.
3. Approximate weights include galvanized steel material, bolts, and nuts.
4. Specified thickness is a nominal galvanized thickness.
5. Gages 12 thru 1 use 3/4" diameter bolts. 5/16 and 3/8 use 7/8" diameter bolts.
6. 24 pi plates are not available in 5/16 and 3/8. Inquire for number of plates per ring.
7. The pi nomenclature for MULTI-PLATE is 3.2. This variance from mathematical pi means that the inside diameter of a MULTI-PLATE round structure will be slightly larger for nominal diameter sizes greater than 120", and the inside diameters will be slightly less for nominal sizes below 120".

MULTI-PLATE®

MULTI-PLATE® Height of Cover Tables

Height of Cover Tables 17, 21, 24, 26 and 29A are presented for the designer's convenience for use in routine applications. These tables are based on the outlined design procedures, using the following values for the soil and steel parameters:

- For live loading other than standard highway vehicles, please contact your Contech representative.
- **Unit weight of soil – 120 pcf.**
- Relative density of compacted backfill – minimum 90% density per AASHTO T-180.
- Heights of cover are based on 3/4" diameter bolts (4 bolts/ft) except 5/16 and 3/8 which use 7/8" diameter bolts. (8 bolts/ft). 6 and 8 bolts/ft are available for 1 gage structures.

TABLE 17. MULTI-PLATE® ROUND AND VERTICAL ELLIPSE PIPE 6" X 2"

LRFD HEIGHT OF COVER GUIDE (HL-93 LOADING)

Diameter (Ft.-In.)	Minimum Cover (Inches)	Gage Thickness (Inches) Maximum Cover Height Shown in Feet									
		Pi	12 (0.111)	10 (0.140)	8 (0.170)	7 (0.188)	5 (0.218)	3 (0.249)	1 (0.280)	5/16 (0.318)	3/8 (0.380)
5-0	12	60	46	67	87	100	121	143	156	250	301
5-6	12	66	42	60	79	91	110	130	142	227	273
6-0	12	72	38	55	73	83	101	119	130	208	250
6-6	12	78	35	51	67	77	93	110	120	192	231
7-0	12	84	32	47	62	71	86	102	111	178	214
7-6	12	90	30	44	58	67	80	95	104	166	200
8-0	12	96	28	41	54	62	75	89	97	156	187
8-6	18	102	27	39	51	59	71	84	91	147	176
9-0	18	108	25	37	48	55	67	79	86	138	166
9-6	18	114	24	35	45	52	63	75	82	131	158
10-0	18	120	22	33	43	50	60	71	77	124	150
10-6	18	126	21	31	41	47	57	68	74	118	143
11-0	18	132	20	30	39	45	54	64	70	113	136
11-6	18	138	19	28	37	43	52	62	67	108	130
12-0	18	144	18	27	36	41	50	59	64	104	125
12-6	24	150	18	26	34	40	48	57	62	99	120
13-0	24	156	17	25	33	38	46	54	59	95	115
13-6	24	162	16	24	32	37	44	52	57	92	111
14-0	24	168	16	23	31	35	43	50	55	89	107
14-6	24	174	15	22	29	34	41	49	53	85	103
15-0	24	180	14	21	28	33	40	47	51	83	99
15-6	24	186	13	21	27	32	38	45	50	80	96
16-0	24	192		20	27	31	37	44	48	77	93
16-6	30	198		19	26	30	36	43	47	75	90
17-0	30	204		19	25	29	35	41	45	73	88
17-6	30	210		18	24	28	34	40	44	71	85
18-0	30	216			23	27	33	39	43	69	83
18-6	30	222			23	26	32	38	41	67	80
19-0	30	228			22	26	31	37	40	65	78
19-6	30	234			22	25	30	36	39	63	76
20-0	30	240				24	29	35	38	62	74
20-6	36	246				24	29	34	37	60	73
21-0	36	252				24	28	33	36	59	71
21-6	36	258					27	32	35	57	69
22-0	36	264					27	32	35	56	67
22-6	36	270					26	31	34	55	66
23-0	36	276						30	33	54	65
23-6	36	282						30	32	52	63
24-0	36	288						29	32	51	62
24-6	42	294							31	49	60
25-0	42	300							30	48	58
25-6	42	306							30	46	56
26-0	42	312								44	54

Notes:

1. Table based upon AASHTO LRFD Bridge Design Specification for Highway Bridges.
2. Per AASHTO 12.6.6.3, minimum cover is the vertical distance from the top of the corrugated structure to the bottom of flexible or top of rigid pavement.
3. Minimum cover for heavy off-road construction equipment loads must be checked. Please contact your Contech representative.

TABLE 18. MULTI-PLATE® VERTICAL ELLIPSE 6" X 2"

WEIGHT TABLES

Diameter (Ft.-In.)	5% Vertical Ellipse		Plate Make-Up					Gage Thickness (Inches) Weight Shown as Pounds per Foot of Structure							
	Horizontal (Inches)	Vertical (Inches)	Area (Sq. Ft.)	Pi				Total Plates	12 (0.111)	10 (0.140)	8 (0.170)	7 (0.188)	5 (0.218)	3 (0.249)	1 (0.280)
				15	18	21	24								
5-0	56	62	19	4				4	110	138	166	180	208	236	264
5-6	62	68	23	2	2			4	119	150	180	196	227	257	287
6-0	68	75	28		4			4	129	162	195	212	245	277	310
6-6	73	81	32		2	2		4	138	174	209	227	263	298	333
7-0	79	88	38			4		4	147	185	223	243	281	318	356
7-6	85	94	44			2	2	4	157	198	239	260	300	341	382
8-0	91	101	50				4	4	168	211	254	276	320	364	407
8-6	97	107	56	2	4			6	184	231	278	302	349	395	442
9-0	103	114	63		6			6	193	242	292	317	367	416	465
9-6	109	120	71		4	2		6	202	254	306	333	385	436	488
10-0	115	127	79		2	4		6	212	266	321	349	403	457	512
10-6	120	133	87			6		6	221	278	335	364	421	478	535
11-0	126	139	95			4	2	6	231	291	350	381	440	500	560
11-6	132	146	104			2	4	6	241	304	366	398	460	523	585
12-0	138	152	114				6	6	251	316	381	415	479	546	611
12-6	142	157	124		6	2		8	267	335	404	439	507	575	644
13-0	148	163	134		4	4		8	276	347	418	454	525	596	667
13-6	154	170	144		2	6		8	285	359	432	470	543	616	690
14-0	159	176	155			8		8	295	371	447	485	561	637	713
14-6	165	183	167			6	2	8	305	384	462	502	581	660	738
15-0	171	189	179			4	4	8	315	396	478	519	600	682	764
15-6	177	195	191			2	6	8	325	409	493	536	620	705	789
16-0	182	202	204				8	8	335	422	508	553	639	728	814
16-6	189	209	217		4	6		10		440	530	576	666	755	845
17-0	195	215	230		2	8		10		452	544	591	684	776	868
17-6	201	222	244			10		10		464	559	607	701	796	891
18-0	206	228	258			8	2	10		476	574	624	721	819	917
18-6	212	235	273			6	4	10			589	640	741	841	942
19-0	218	241	288			4	6	10			605	657	760	864	967
19-6	224	247	303			2	8	10			620	674	780	887	993
20-0	229	253	319				10	10			635	691	799	909	1018
20-6	236	261	336		2	10		12				713	824	935	1046
21-0	242	267	352			12		12				728	842	955	1069
21-6	247	273	370			10	2	12					861	978	1095
22-0	253	280	387			8	4	12					881	1001	1120
22-6	259	286	405			6	6	12					900	1023	1145
23-0	264	291	423			4	8	12					920	1046	1171
23-6	271	299	442			2	10	12						1069	1196
24-0	276	305	461				12	12						1091	1222
24-6	283	312	481			14		14						1115	1248
25-0	289	319	501			12	2	14						1137	1273
25-6	294	325	521			10	4	14						1160	1298
26-0	300	332	542			8	6	14						1183	1324

Notes:

1. Dimensions are to inside crests of corrugations and are subject to manufacturing tolerances.
2. These plate arrangements will be furnished unless noted otherwise on assembly drawings.
3. Approximate weights include galvanized steel material, bolts, and nuts.
4. Specified thickness is a nominal galvanized thickness.

MULTI-PLATE®

TABLE 19. MULTI-PLATE® PIPE-ARCH 6" X 2" DETAILS

	Span (Ft.-In.)	Rise (Ft.-In.)	Area (Sq. Ft.)	R_t (Inches)	R_b (Inches)	C^{**} (Inches)		Span (Ft.-In.)	Rise (Ft.-In.)	Area (Sq. Ft.)	R_t (Inches)	R_b (Inches)	C^{**} (Inches)
	9 Pi Corner Pipe Arch Structure							15 Pi Corner Pipe Arch Structure					
R_c Corner Radius = 18"	6-1	4-7	22	37	77	27	R_c Corner Radius = 31"	13-3	9-4	98	80	193	47
	6-4	4-9	24	38	99	25		13-6	9-6	102	81	220	45
	6-9	4-11	26	41	84	29		14-0	9-8	106	84	198	48
	7-0	5-1	29	42	105	27		14-2	9-10	111	86	224	46
	7-3	5-3	31	44	137	25		14-5	10-0	115	87	256	44
	7-8	5-5	33	47	110	28		14-11	10-2	120	90	228	48
	7-11	5-7	36	48	139	27		15-4	10-4	124	93	209	51
	8-2	5-9	38	49	183	25		15-7	10-6	129	94	232	49
	8-7	5-11	41	52	141	28		15-10	10-8	134	95	261	47
	8-10	6-1	43	53	179	26		16-3	10-10	138	99	237	51
	9-4	6-3	46	56	145	30		16-6	11-0	143	100	264	49
	9-6	6-5	49	57	178	28		17-0	11-2	148	103	241	53
	9-9	6-7	52	58	228	26		17-2	11-4	153	104	267	51
	10-3	6-9	55	62	179	29		17-5	11-6	158	105	298	49
	10-8	6-11	58	65	153	33		17-11	11-8	163	108	271	52
	10-11	7-1	61	66	181	31		18-1	11-10	168	109	300	50
	11-5	7-3	64	69	158	34		18-7	12-0	174	113	274	54
	11-7	7-5	68	70	184	32		18-9	12-2	179	114	302	52
11-10	7-7	71	71	217	30	19-3	12-4	185	117	278	55		
12-4	7-9	74	75	187	34	19-6	12-6	191	118	305	53		
12-6	7-11	78	76	218	32	19-8	12-8	196	119	337	51		
12-8	8-1	82	77	260	30	19-11	12-10	202	120	374	49		
12-10	8-4	85	77	315	28	20-5	13-0	208	123	338	53		
							20-7	13-2	214	124	374	51	

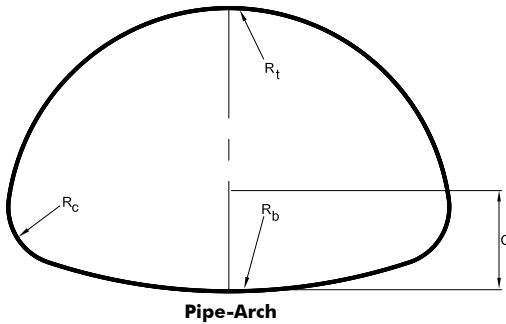

* Pipe arch shapes with a corner radius of 18" are available in larger sizes than 12'-10" x 8'-4".
 ** "C" is measured from the invert to the top of the corner plate.



End view of an assembled MULTI-PLATE Pipe Arch

TABLE 20. MULTI-PLATE® PIPE-ARCH 6" X 2"

WEIGHT TABLES

Span (Ft.-In.)	Rise (Ft.-In.)	Pi	Plate Make-Up C = Corner B = Bottom T = Top (see Note 4)										Total Plates	Gage Thickness (Inches) Weight Shown as Pounds per Foot of Structure								
			9 Pi		15 Pi			18 Pi		21 Pi		24 Pi		12	10	8	7	5	3	1		
			C	B	C	B	T	B	T	B	T	B		T	(0.111)	(0.140)	(0.170)	(0.188)	(0.218)	(0.249)	(0.280)	
9 Pi Corner Pipe Arch Structure*																						
6-1	4-7	66	2			1	1		1					5	136	158	180	196	227	257	287	
6-4	4-9	69	2			1			2					5	142	165	188	204	236	267	299	
6-9	4-11	72	2					1	2					5	147	171	195	212	245	277	310	
7-0	5-1	75	2					1	1			1		5	152	178	202	219	254	288	322	
7-3	5-3	78	2					1				2		5	158	185	209	227	263	298	333	
7-8	5-5	81	2									1	2	5	163	192	216	235	272	308	345	
7-11	5-7	84	2									1	1	5	168	198	223	243	281	318	356	
8-2	5-9	87	2									1		5	174	205	231	251	290	330	369	
8-7	5-11	90	2										1	2	5	179	212	239	260	300	341	382
8-10	6-1	93	2				1		2				1	6	185	219	246	268	310	352	395	
9-4	6-3	96	2	1			1	1	2					7	190	226	258	281	324	368	412	
9-6	6-5	99	2	1				1	3					7	195	232	266	289	334	380	425	
9-9	6-7	102	2	1				1	2			1		7	201	239	273	296	342	389	435	
10-3	6-9	105	2				2		2			1		7	206	246	280	304	352	399	447	
10-8	6-11	108	2				1		1	2		1		7	211	253	287	312	361	409	458	
10-11	7-1	111	2				1		1	1		2		7	217	259	295	320	370	421	471	
11-5	7-3	114	2					2	1			2		7	222	266	302	329	380	432	484	
11-7	7-5	117	2					2				3		7	227	273	310	337	390	443	496	
11-10	7-7	120	2					2				2		1	7	233	280	321	349	404	458	513
12-4	7-9	123	2					1		1	2		1	7	238	286	329	358	413	469	525	
12-6	7-11	126	2					1		1	1		2	7	244	293	336	365	422	480	537	
12-8	8-1	129	2					1		1			3	7	249	300	343	373	431	490	549	
12-10	8-4	132	2					1	3	1	1			8	254	307	352	382	442	502	562	
15 Pi Corner Pipe Arch Structure																						
13-3	9-4	138			2			2					3	7		308	371	403	466	529	593	
13-6	9-6	141			2			2	3			1		8		317	382	415	480	544	609	
14-0	9-8	144			2			1	3	1	1			8		323	389	423	489	554	620	
14-2	9-10	147			2			1	2	1	2			8		329	397	431	498	565	632	
14-5	10-0	150			2			1	1	1	3			8		335	404	439	507	575	644	
14-11	10-2	153			2				1	2	3			8		341	411	446	516	585	655	
15-4	10-4	156			2				1	1	3	1		8		348	419	455	526	597	668	
15-7	10-6	159			2					1	4	1		8		354	426	463	535	607	679	
15-10	10-8	162			2					1	3	1	1	8		360	434	471	545	618	692	
16-3	10-10	165			2						3	2	1	8		366	441	479	554	630	705	
16-6	11-0	168			2						2	2	2	8		373	449	488	564	641	717	
17-0	11-2	171			2	1		2			2		2	9		383	461	501	579	657	735	
17-2	11-4	174			2	1		2			1		3	9		389	468	509	589	668	748	
17-5	11-6	177			2	1		2					4	9		395	476	517	598	679	760	
17-11	11-8	180			2			3					4	9		401	483	525	607	690	772	
18-1	11-10	183			2			3	2			3		10		410	494	537	621	703	787	
18-7	12-0	186			2			2	2	1	3			10		416	501	545	629	714	799	
18-9	12-2	189			2			2	1	1	4			10		422	508	552	638	724	810	
19-3	12-4	192			2			1	1	2	4			10		428	516	560	647	734	822	
19-6	12-6	195			2			1		2	5			10		434	523	568	656	745	833	
19-8	12-8	198			2			1		2	4		1	10		440	530	576	666	756	846	
19-11	12-10	201			2			1		2	3		2	10		447	538	585	676	767	859	
20-5	13-0	204			2					3	3		2	10		453	545	592	685	778	870	
20-7	13-2	207			2					3	2		3	10		459	553	601	695	789	883	

Notes:

1. Dimensions are to inside crests of corrugations and are subject to manufacturing tolerances.
2. These plate arrangements will be furnished unless noted otherwise on assembly drawings.
3. Approximate weights include galvanized steel material, bolts, and nuts.
4. Pipe arch shapes with a corner radius of 18" are available in larger sizes than 12'-10" x 8'-4".
- *5. These structures may be supplied with the corner plates in a heavier gage than specified.

R_c Corner Radius = 18"

R_c Corner Radius = 31"

MULTI-PLATE®

TABLE 21. MULTI-PLATE® PIPE-ARCH 6" X 2"
LRFD HEIGHT OF COVER GUIDE (HL-93 LOADING)

9 Pi Corner Pipe Arch Structure										
Span (Ft.-In.)	Rise (Ft.-In.)	Minimum Cover (Inches)	Corner Radius (Inches)	Gage Thickness (Inches)						
				Maximum Cover Height Shown in Feet						
				12 (0.111)	10 (0.140)	8 (0.170)	7 (0.188)	5 (0.218)	3 (0.249)	1 (0.280)
6-1	4-7	12	18	14	14	14	14	14	14	14
6-4	4-9	12	18	13	13	13	13	13	13	13
6-9	4-11	12	18	12	12	12	12	12	12	12
7-0	5-1	12	18	12	12	12	12	12	12	12
7-3	5-3	12	18	11	11	11	11	11	11	11
7-8	5-5	12	18	10	10	10	10	10	10	10
7-11	5-7	12	18	10	10	10	10	10	10	10
8-2	5-9	18	18	10	10	10	10	10	10	10
8-7	5-11	18	18	9	9	9	9	9	9	9
8-10	6-1	18	18	9	9	9	9	9	9	9
9-4	6-3	18	18	8	8	8	8	8	8	8
9-6	6-5	18	18	8	8	8	8	8	8	8
9-9	6-7	18	18	8	8	8	8	8	8	8
10-3	6-9	18	18	7	7	7	7	7	7	7
10-8	6-11	18	18	6	6	6	6	6	6	6
10-11	7-1	18	18	6	6	6	6	6	6	6
11-5	7-3	18	18	6	6	6	6	6	6	6
11-7	7-5	18	18	6	6	6	6	6	6	6
11-10	7-7	18	18	5	5	5	5	5	5	5
12-4	7-9	24	18	5	5	5	5	5	5	5
12-6	7-11	24	18	5	5	5	5	5	5	5
12-8	8-1	24	18	5	5	5	5	5	5	5
12-10	8-4	24	18	5	5	5	5	5	5	5
15 Pi Corner Pipe Arch Structure										
13-3	9-4	24	31		11	11	11	11	11	11
13-6	9-6	24	31		11	11	11	11	11	11
14-0	9-8	24	31		10	10	10	10	10	10
14-2	9-10	24	31		10	10	10	10	10	10
14-5	10-0	24	31		10	10	10	10	10	10
14-11	10-2	24	31		9	9	9	9	9	9
15-4	10-4	24	31		9	9	9	9	9	9
15-7	10-6	24	31		9	9	9	9	9	9
15-10	10-8	24	31		9	9	9	9	9	9
16-3	10-10	30	31		8	8	8	8	8	8
16-6	11-0	30	31		8	8	8	8	8	8
17-0	11-2	30	31		8	8	8	8	8	8
17-2	11-4	30	31		8	8	8	8	8	8
17-5	11-6	30	31		8	8	8	8	8	8
17-11	11-8	30	31		7	7	7	7	7	7
18-1	11-10	30	31		7	7	7	7	7	7
18-7	12-0	30	31		7	7	7	7	7	7
18-9	12-2	30	31		7	7	7	7	7	7
19-3	12-4	30	31		7	7	7	7	7	7
19-6	12-6	30	31		7	7	7	7	7	7
19-8	12-8	30	31		6	6	6	6	6	6
19-11	12-10	30	31		6	6	6	6	6	6
20-5	13-0	36	31		6	6	6	6	6	6
20-7	13-2	36	31		6	6	6	6	6	6

Notes:

1. Table based upon AASHTO LRFD Bridge Design Specification for Highway Bridges.
2. Per AASHTO 12.6.6.3, minimum cover is the vertical distance from the top of the corrugated structure to the bottom of flexible or top of rigid pavement.
3. Minimum cover for heavy off-road construction equipment must be checked. Please contact your Contech representative.
4. Maximum cover requires minimum 4,000 psf allowable bearing capacity for backfill around haunch of pipe-arch.
5. Maximum cover limited by corner bearing pressure.

TABLE 22. MULTI-PLATE® SINGLE RADIUS ARCH 6" X 2"

Dimensions		Rise/Span Ratio	Radius (Inches)	Waterway (Area Ft. ²)	Nominal Arc Length	Plate Make-Up (see Note 2)					
Span (Ft.-In.)	Rise (Ft.-In.)				Pi	9 Pi	15 Pi	18 Pi	21 Pi	24 Pi	Total Plates
6-0	1-10	0.30	41	7.9	27	1		1			2
	2-4	0.38	37	10.0	30		2				2
	3-2	0.53	36	15.0	36		1		1		2
7-0	2-5	0.34	45	12.1	33		1	1			2
	2-10	0.41	43	14.9	36		1		1		2
	3-8	0.52	42	20.4	42			1		1	2
8-0	2-11	0.36	51	17.0	39			1	1		2
	3-4	0.42	49	20.3	42			1		1	2
	4-2	0.52	48	26.6	48					2	2
9-0	2-11	0.33	59	19.2	42			1		1	2
	3-11	0.43	55	26.5	48					2	2
	4-8	0.52	54	33.6	54			3			3
10-0	3-6	0.35	64	25.4	48					2	2
	4-5	0.44	61	33.5	54			3			3
	5-3	0.52	60	41.4	60			1	2		3
11-0	3-6	0.32	73	27.8	51		1	2			3
	4-6	0.41	68	36.9	57			2	1		3
	5-9	0.52	66	50.0	66				2	1	3
12-0	4-1	0.34	78	35.3	57			2	1		3
	5-0	0.42	73	45.2	63				3		3
	6-3	0.52	72	59.4	72					3	3
13-0	4-1	0.33	87	38.1	60			1	2		3
	5-1	0.40	81	48.9	66				2	1	3
	6-9	0.52	78	69.7	78			2	2		4
14-0	4-8	0.31	91	47.0	66				2	1	3
	5-7	0.38	86	58.5	72					3	3
	7-3	0.44	84	80.7	84			2		2	4
15-0	4-8	0.52	101	48.9	69				1	2	3
	5-8	0.33	93	62.8	75			3	1		4
	6-7	0.44	91	74.8	81			1	3		4
	7-9	0.52	90	92.6	90				2	2	4
16-0	5-3	0.31	105	60.1	75			3	1		4
	7-1	0.42	97	86.2	87				3	1	4
	8-4	0.52	96	105.3	96			3	2		5
17-0	5-3	0.31	115	63.4	78			2	2		4
	7-2	0.42	103	91.9	90				2	2	4
	8-10	0.52	102	118.8	102			1	4		5
18-0	5-9	0.32	119	74.8	84			2		2	4
	7-8	0.43	109	104.6	96			3	2		5
	8-11	0.50	108	126.0	105				5		5
19-0	6-4	0.33	123	87.1	90			2		2	4
	8-3	0.43	115	118.1	102			1	4		5
	9-5	0.50	114	140.7	111				3	2	5
20-0	6-4	0.32	133	91.0	93				1	3	4
	8-3	0.42	122	124.4	105				5		5
	10-0	0.50	120	156.3	117				1	4	5
21-0	6-11	0.33	137	104.6	99			2	3		5
	8-10	0.42	128	139.2	111				3	2	5
	10-6	0.50	126	172.6	123			1	5		6
22-0	6-11	0.32	146	109.3	102			1	4		5
	8-11	0.40	135	145.9	114				2	3	5
	11-0	0.50	132	189.8	129				5	1	6
23-0	8-0	0.35	147	133.6	111				3	2	5
	9-10	0.43	140	171.1	123			1	5		6
	11-6	0.50	138	207.8	135				3	3	6
24-0	8-6	0.36	152	149.4	117				1	4	5
	10-4	0.43	146	188.3	129				5	1	6
	12-0	0.50	144	226.6	141				1	5	6
25-0	8-7	0.34	160	155.6	120					5	5
	10-10	0.43	152	206.3	135				3	3	6
	12-6	0.50	150	246.2	147				7		7
26-0	8-7	0.33	169	161.4	123			1	5		6
	11-0	0.42	158	214.9	138				2	4	6
	13-1	0.50	156	266.7	153				5	2	7

Notes:

1. Dimensions are to inside crests of corrugations are subject to manufacturing tolerances.
2. These plate arrangements will be furnished unless otherwise noted on assembly drawings.
3. Additional arch sizes with a Rise-to-Span ratio in the range of 0.30 to 0.65 are available. Contact your Contech representative.

TABLE 23. MULTI-PLATE® SINGLE RADIUS ARCH 6" X 2"

WEIGHT TABLES							
Arc Length	Gage Thickness (Inches)						
	Weight Shown as Pounds per Foot of Structure						
Pi	12 (0.111)	10 (0.140)	8 (0.170)	7 (0.188)	5 (0.218)	3 (0.249)	1 (0.280)
24	42	53	64	69	80	91	102
27	50	63	76	82	95	108	120
30	55	69	83	90	104	118	132
33	60	75	90	98	113	128	144
36	64	81	97	106	122	139	155
39	69	87	105	114	131	149	167
42	74	93	112	121	140	159	178
45	79	99	119	130	150	171	191
48	84	105	127	138	160	182	204
51	92	115	139	151	174	198	221
54	96	121	146	159	184	208	233
57	101	127	153	167	193	218	244
60	106	133	160	174	201	229	256
63	110	139	168	182	210	239	267
66	116	145	175	190	220	250	280
69	121	152	183	199	230	262	293
72	126	158	191	207	240	273	305
75	133	168	202	219	254	288	322
78	138	174	209	227	263	298	333
81	143	179	216	235	272	308	345
84	147	185	223	243	281	318	356
87	152	192	231	251	290	330	369
90	157	198	239	260	300	341	382
93	163	205	246	268	310	352	395
96	168	211	254	276	320	364	407
99	175	220	265	288	333	377	422
102	179	226	272	296	342	388	434
105	184	232	279	303	351	398	446
108		238	287	312	361	409	458
111		245	295	320	370	421	471
114		251	302	329	380	432	484
117		257	310	337	390	443	496
120		264	318	345	400	455	509
123			328	356	412	467	523
126			335	364	421	478	535
129			343	372	431	489	547
132				381	440	500	560
135				389	450	512	573
138				398	460	523	585
141				406	470	534	598
144					479	546	611
147					491	557	624
150					503	567	636
153					515	575	650

Notes:

1. Approximate weights include galvanized steel material, bolts, and nuts.
2. Gages 5/16 and 3/8 are available. Contact your Contech representative.

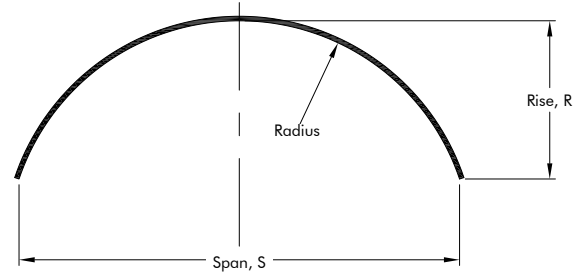

Single Radius Arch – R/S < 0.50

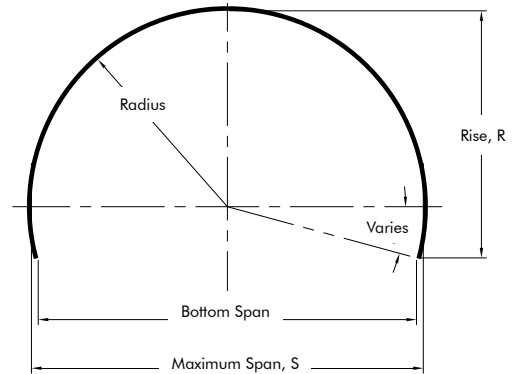

Single Radius Arch – R/S > 0.50

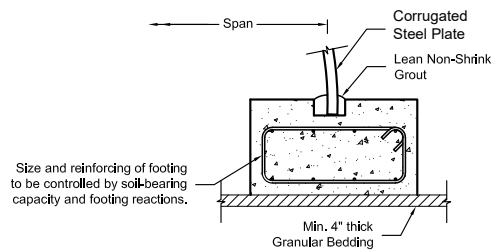

Slotted Concrete Footing

For a single radius arch, the dimensions of the keyway shall be a minimum of 4" height x 8" wide.



MULTI-PLATE Pedestrian Arch Tunnel

TABLE 24. MULTI-PLATE® SINGLE RADIUS ARCH 6" X 2"

LRFD HEIGHT OF COVER GUIDE (HL-93 LOADING)

Span (Ft.-In.)	Rise (Ft.-In.)	Total Pi	Minimum Cover (Inches)	Gage Thickness (Inches)								
				Maximum Cover Height Shown in Feet								
				12 (0.111)	10 (0.140)	8 (0.170)	7 (0.188)	5 (0.218)	3 (0.249)	1 (0.280)	5/16 (0.318)	3/8 (0.380)
6-0	1-10	27	12	38	55	73	83	101	119	130	208	250
	2-4	30	12	38	55	73	83	101	119	130	208	250
	3-2	36	12	38	55	73	83	101	119	130	208	250
7-0	2-5	33	12	32	47	62	71	86	102	111	178	214
	2-10	36	12	32	47	62	71	86	102	111	178	214
	3-8	42	12	32	47	62	71	86	102	111	178	214
8-0	2-11	39	12	28	41	54	62	75	89	97	156	187
	3-4	42	12	28	41	54	62	75	89	97	156	187
	4-2	48	12	28	41	54	62	75	89	97	156	187
9-0	2-11	42	18	25	37	48	55	67	79	86	138	166
	3-11	48	18	25	37	48	55	67	79	86	138	166
	4-8	54	18	25	37	48	55	67	79	86	138	166
10-0	3-6	48	18	22	33	43	50	60	71	77	124	150
	4-5	54	18	22	33	43	50	60	71	77	124	150
	5-3	60	18	22	33	43	50	60	71	77	124	150
11-0	3-6	51	18	20	30	39	45	54	64	70	113	136
	4-6	57	18	20	30	39	45	54	64	70	113	136
	5-9	66	18	20	30	39	45	54	64	70	113	136
12-0	4-1	57	18	18	27	36	41	50	59	64	104	125
	5-0	63	18	18	27	36	41	50	59	64	104	125
	6-3	72	18	18	27	36	41	50	59	64	104	125
13-0	4-1	60	24	17	25	33	38	46	54	59	95	115
	5-1	66	24	17	25	33	38	46	54	59	95	115
	6-9	78	24	17	25	33	38	46	54	59	95	115
14-0	4-8	66	24	16	23	31	35	43	50	55	89	107
	5-7	72	24	16	23	31	35	43	50	55	89	107
	7-3	84	24	16	23	31	35	43	50	55	89	107
15-0	4-8	69	24	14	21	28	33	40	47	51	83	99
	5-8	75	24	14	21	28	33	40	47	51	83	99
	6-7	81	24	14	21	28	33	40	47	51	83	99
	7-9	90	24	14	21	28	33	40	47	51	83	99
16-0	5-3	75	24	12	20	27	31	37	44	48	77	93
	7-1	87	24	12	20	27	31	37	44	48	77	93
	8-4	96	24	12	20	27	31	37	44	48	77	93
17-0	5-3	78	30	12	19	25	29	35	41	45	73	88
	7-2	90	30	12	19	25	29	35	41	45	73	88
	8-10	102	30	12	19	25	29	35	41	45	73	88
18-0	5-9	84	30	11	17	23	27	33	39	43	69	83
	7-8	96	30	11	17	23	27	33	39	43	69	83
	8-11	105	30	11	17	23	27	33	39	43	69	83
19-0	6-4	90	30	10	16	22	26	31	37	40	65	78
	8-3	102	30	10	16	22	26	31	37	40	65	78
	9-5	111	30	10	16	22	26	31	37	40	65	78
20-0	6-4	93	30		15	21	24	29	35	38	62	74
	8-3	105	30		15	21	24	29	35	38	62	74
	10-0	117	30		15	21	24	29	35	38	62	74
21-0	6-11	99	36		14	20	23	28	33	36	59	71
	8-10	111	36		14	20	23	28	33	36	59	71
	10-6	123	36		14	20	23	28	33	36	59	71
22-0	6-11	102	36			19	22	27	32	35	56	67
	8-11	114	36			19	22	27	32	35	56	67
	11-0	129	36			19	22	27	32	35	56	67
23-0	8-0	111	36			18	21	26	30	33	54	65
	9-10	123	36			18	21	26	30	33	54	65
	11-6	135	36			18	21	26	30	33	54	65
24-0	8-6	117	36			17	20	24	29	32	51	62
	10-4	129	36			17	20	24	29	32	51	62
	12-0	141	36			17	20	24	29	32	51	62
25-0	8-7	120	42				19	23	28	30	48	58
	10-10	135	42				19	23	28	30	48	58
	12-6	147	42				19	23	28	30	48	58
26-0	8-7	123	42					22	27	29	44	54
	11-0	138	42					22	27	29	44	54
	13-1	153	42					22	27	29	44	54

Notes:

1. For live loading other than standard highway vehicles, please contact your Contech representative.
2. Per AASHTO 12.6.6.3, minimum cover is the vertical distance from the top of the corrugated structure to the bottom of flexible or top of rigid pavement.
3. Minimum cover for heavy off-road construction equipment loads must be checked.
4. Footing reactions can be provided by Contech. Contact your Contech representative.

TABLE 25. MULTI-PLATE® HORIZONTAL ELLIPSE 6" X 2" DETAILS

Structure Number	Span (Ft.-In.)	Rise (Ft.-In.)	Total Pi	Area (Sq. Ft.)	R _t (Inches)	R _s (Inches)
24E15	7-4	5-6	78	32	54	27
27E15	8-1	5-9	84	36	61	27
30E15	8-10	6-0	90	41	68	27
30E18	9-2	6-9	96	48	68	32
33E15	9-7	6-4	96	47	75	27
33E18	9-11	7-0	102	54	75	32
36E15	10-4	6-7	102	53	82	27
36E18	10-8	7-3	108	60	82	32
36E21	11-0	8-0	114	68	82	38
39E15	11-1	6-10	108	58	88	27
39E18	11-4	7-6	114	66	88	32
39E21	11-8	8-3	120	75	88	38
39E24	12-0	8-11	126	84	88	43
42E15	11-9	7-1	114	64	95	27
42E18	12-1	7-10	120	73	95	32
42E21	12-5	8-6	126	82	95	38
42E24	12-9	9-2	132	92	95	43
45E15	12-6	7-4	120	71	102	27
45E18	12-10	8-1	126	80	102	32
45E21	13-2	8-9	132	90	102	38
45E24	13-6	9-6	138	100	102	43
48E18	13-7	8-4	132	87	109	32
48E21	13-11	9-0	138	97	109	38
48E24	14-3	9-9	144	109	109	43
48E27	14-7	10-5	150	119	109	49
48E30	14-11	11-2	156	130	109	54

Notes:

1. Dimensions are to inside crests of corrugations and are subject to manufacturing tolerances.
2. Plate arrangements can be determined by the structure number, (i.e. Structure 45E21 has a plate makeup consisting of a 24 pi and a 21 pi plate in both the top and bottom and a 21 pi plate in each side for a total of 132 pi).



Horizontal Ellipse Assembly

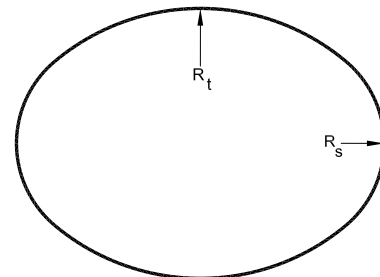

Horizontal Ellipse

TABLE 26. MULTI-PLATE® HORIZONTAL ELLIPSE 6" X 2"

LRFD HEIGHT OF COVER GUIDE (HL-93 LOADING)					
Structure Number	Span (Ft.-In.)	Rise (Ft.-In.)	Total Pi	Minimum Cover (Inches)	Maximum Cover (Feet) For Corner Bearing Pressure of 4,000 psf
24E15	7-4	5-6	78	12	14
27E15	8-1	5-9	84	18	12
30E15	8-10	6-0	90	18	11
30E18	9-2	6-9	96	18	13
33E15	9-7	6-4	96	18	9
33E18	9-11	7-0	102	18	12
36E15	10-4	6-7	102	18	8
36E18	10-8	7-3	108	18	11
36E21	11-0	8-0	114	18	13
39E15	11-1	6-10	108	18	8
39E18	11-4	7-6	114	18	10
39E21	11-8	8-3	120	18	12
39E24	12-0	8-11	126	18	14
42E15	11-9	7-1	114	18	7
42E18	12-1	7-10	120	24	9
42E21	12-5	8-6	126	24	11
42E24	12-9	9-2	132	24	13
45E15	12-6	7-4	120	24	6
45E18	12-10	8-1	126	24	8
45E21	13-2	8-9	132	24	10
45E24	13-6	9-6	138	24	12
48E18	13-7	8-4	132	24	7
48E21	13-11	9-0	138	24	9
48E24	14-3	9-9	144	24	11
48E27	14-7	10-5	150	24	13
48E30	14-11	11-2	156	24	15

Notes:

1. Table based upon AASHTO LRFD Bridge Design Specification for Highway Bridges.
2. Per AASHTO 12.6.6.3, minimum cover is the vertical distance from the top of the corrugated structure to the bottom of flexible or top of rigid pavement.
3. Minimum cover for heavy off-road construction equipment loads must be checked.
4. Maximum cover based on 12 gage. Heavier gages can be supplied.
5. Maximum cover requires minimum 4,000 psf allowable bearing capacity for backfill around haunch of horizontal ellipse.
6. Maximum cover limited by corner bearing pressure.



Horizontal Ellipse Stream Crossing with Aluminum Headwall and Stone Veneer

TABLE 27. MULTI-PLATE® UNDERPASS 6" X 2" DETAILS

Span (Ft.-In.)	Rise (Ft.-In.)	Total Pi	Area (Sq. Ft.)	R _t (Inches)	R _s (Inches)	R _c (Inches)	R _b (Inches)
Junior Underpasses							
5-8	5-9	72	27	28	53	18	Flat
5-9	6-6	78	31	30	75	18	Flat
5-9	7-4	84	36	29	95	18	Flat
5-10	7-8	87	38	30	113	18	Flat
5-10	8-2	90	40	28	117	18	Flat
Standard Underpasses							
12-2	11-0	141	107	67	93	38	134
12-11	11-3	147	116	73	95	38	144
13-2	11-11	153	126	73	103	38	159
13-10	12-3	159	136	77	108	38	164
14-1	12-10	165	147	77	115	38	182
14-6	13-5	171	158	78	130	38	174
14-10	14-0	177	169	79	136	38	192
15-6	14-4	183	180	84	138	38	201
15-9	15-1	189	192	83	150	38	212
16-4	15-5	195	204	86	157	38	215
16-5	16-1	201	217	88	158	38	271
16-9	16-3	204	224	89	167	38	247
17-3	17-0	210	239	90	174	47	215
18-4	16-11	216	252	100	157	47	249
19-2	17-2	222	266	105	156	47	264
19-6	17-7	228	280	107	158	47	297
20-4	17-10	234	295	113	156	47	314



MULTI-PLATE Golf Cart Underpass

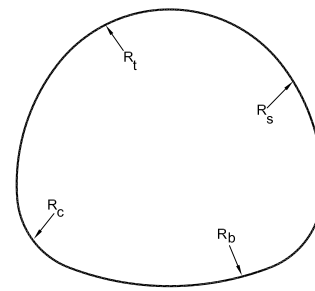

Underpass

TABLE 28. MULTI-PLATE® UNDERPASS 6" X 2"

PLATE MAKE-UP																						
Span (Ft.-In.)	Rise (Ft.-In.)	Total Pi	Top				Sides				Corners			Bottom					Total Plates Per Ring			
			15	18	21	24	9	15	18	21	24	9	15	18	9	15	18	21		24		
Junior Underpasses																						
5-8	5-9	72	1							2				2				1			6	
5-9	6-6	78			1					2				2				1			6	
5-9	7-4	84			1						2			2				1			6	
5-10	7-8	87				1					2			2				1			6	
5-10	8-2	90			1							2		2				1			6	
Standard Underpasses																						
12-2	11-0	141		1	1						2			2				2			8	
12-11	11-3	147			2						2			2				1	1		8	
13-2	11-11	153			2							2		2				1	1		8	
13-10	12-3	159			1	1							2	2					2		8	
14-1	12-10	165			1	1	2			2				2					2		10	
14-6	13-5	171				2	2			2				2					1	1	10	
14-10	14-0	177				2			4					2					1	1	10	
15-6	14-4	183	1	2					4					2						2	11	
15-9	15-1	189	1	2					2	2				2						2	11	
16-4	15-5	195		3					2	2				2						1	1	11
16-5	16-1	201		2	1					4				2						2	11	
16-9	16-3	204		2	1					4				2						1	1	11
17-3	17-0	210		2	1					4						2				1	1	11
18-4	16-11	216		1	2					4				2							2	11
19-2	17-2	222			3					4					2			1	2			12
19-6	17-7	228			3					2	2				2			1	2			12
20-4	17-10	234			2	1				2	2				2					3		12

Notes:

1. These plate arrangements will be furnished unless noted otherwise on assembly drawings.
2. Dimensions are to inside crests of corrugations and are subject to manufacturing tolerances.

TABLE 29. MULTI-PLATE® UNDERPASS 6" X 2"

WEIGHT TABLES										
Span (Ft.-In.)	Rise (Ft.-In.)	Area (Sq. Ft.)	Total Pi	Gage Thickness (Inches)						
				Weight Shown as Pounds per Foot of Structure						
				12 (0.111)	10 (0.140)	8 (0.170)	7 (0.188)	5 (0.218)	3 (0.249)	1 (0.280)
Junior Underpasses										
5-8	5-9	27	72	144	167	192	213	246	279	312
5-9	6-6	31	78	155	181	207	231	267	303	339
5-9	7-4	36	84	165	194	223	249	287	326	365
5-10	7-8	38	87	170	200	231	258	298	338	378
5-10	8-2	40	90	176	207	239	266	308	349	391
Standard Underpasses										
12-2	11-0	107	141	253	318	382	415	480	544	609
12-11	11-3	116	147	262	329	397	431	498	565	632
13-2	11-11	126	153	272	342	412	448	518	587	657
13-10	12-3	136	159	282	354	427	464	536	609	682
14-1	12-10	147	165	299	375	452	491	567	642	719
14-6	13-5	158	171	309	388	466	507	586	664	743
14-10	14-0	169	177	318	399	481	522	604	685	766
15-6	14-4	180	183	331	415	500	543	627	711	795
15-9	15-1	192	189		427	514	558	645	731	818
16-4	15-5	204	195		439	529	575	664	753	843
16-5	16-1	217	201		451	543	590	682	773	865
16-9	16-3	224	204		457	550	598	691	784	877
17-3	17-0	239	210		469	565	614	710	805	901
18-4	16-11	252	216			580	630	728	826	925
19-2	17-2	266	222			599	650	752	852	954
19-6	17-7	280	228			613	666	770	873	977
20-4	17-10	298	234				682	789	894	1001

Notes:

1. Dimensions are to inside crests of corrugations and are subject to manufacturing tolerances.
2. Approximate weights include galvanized steel material, bolts, and nuts.

TABLE 29A. MULTI-PLATE® UNDERPASS 6" X 2"

LRFD HEIGHT OF COVER GUIDE (HL-93 LOADING)

Span (Ft.-In.)	Rise (Ft.-In.)	Total Pi	Radius, Inches R _c Corner	Minimum Thickness (Gage)	Minimum Cover (Inches)	Maximum Height of Cover (Feet)
Junior Underpasses						
5-8	5-9	72	18	12	12	18
5-9	6-6	78	18	12	12	18
5-9	7-4	84	18	12	12	18
5-10	7-8	87	18	12	12	18
5-10	8-2	90	18	12	12	18
Standard Underpasses						
12-2	11-0	141	38	12	24	18
12-11	11-3	147	38	12	24	15
13-2	11-11	153	38	12	24	15
13-10	12-3	159	38	12	24	14
14-1	12-10	165	38	12	24	14
14-6	13-5	171	38	12	24	14
14-10	14-0	177	38	12	24	14
15-6	14-4	183	38	12	24	13
15-9	15-1	189	38	10	24	13
16-4	15-5	195	38	10	36	13
16-5	16-1	201	38	10	36	13
16-9	16-3	204	38	10	36	12
17-3	17-0	210	47	10	36	15
18-4	16-11	216	47	8	36	14
19-2	17-2	222	47	8	36	13
19-6	17-7	228	47	8	36	13
20-4	17-10	234	47	7	36	12

Note:

1. Maximum height of cover over underpass for corner bearing pressures of 4,000 psf.
2. Per AASHTO 12.6.6.3, minimum cover is the vertical distance from the top of the corrugated structure to the bottom of flexible or top of rigid pavement.

MULTI-PLATE® Galvanized Steel Structure Plate Project Specification

Scope: This specification covers the manufacture and installation of the galvanized steel structural plate structure detailed in the plans.

Material: The galvanized steel structural plate structure shall consist of plate and appurtenant items as shown on the plans and shall conform to the requirements of AASHTO M 167/ASTM A761. All manufacturing processes, including corrugating, punching, curving and galvanizing, shall be performed within the United States using raw materials made in the United States.

Assembly bolts with suitable nuts shall be galvanized and meet the provisions of ASTM A449, Type 1 and ASTM A563, Grade C, respectively.

Assembly: The structure shall be assembled in accordance with the shop drawings provided by the manufacturer and per the manufacturer's recommendations. Bolts shall be tightened using an applied torque of between 100 and 300 ft.-lbs. When seam sealant tape is used, bolts shall be installed and retightened to these torque levels after 24 hours. Torque levels are for installation, not residual, in-service requirements.

Installation: The structure shall be installed in accordance with the plans and specifications, the manufacturer's recommendations, and the AASHTO LRFD Bridge Construction Specifications (Sec. 26) (Division II).

Backfill: The structure shall be backfilled using clean, well graded granular material that meets the requirements of AASHTO M 145 for soil classification A-1, A-2-4, A-2-5, or A-3. Backfill must be placed symmetrically on each side of the structure in 8-inch uncompacted lifts, with no side-to-side differential exceeding 24-inches. Each lift shall be compacted to a minimum 90% density per AASHTO T-180.

Notes: Construction loads that exceed highway load limits are not allowed on the structure without approval from the Project Engineer.



Black Steel MULTI-PLATE before the Zinc Tank

MULTI-PLATE® Galvanized Steel Key-Hole Slot Structural Plate Project Specification

Scope: This specification covers the manufacture and installation of the galvanized steel structural plate structure detailed in the plans.

Material: The galvanized steel structural plate structure shall consist of plates and appurtenant items as shown on the plans and shall conform to the requirements of AASHTO M 167/ASTM A761 except the longitudinal seam bolt holes shall be key-hole shaped as shown in the plans. All manufacturing processes including corrugating, punching, curving and galvanizing, shall be performed within the United States using raw materials made in the United States.

Assembly bolts and nuts shall be galvanized and meet the provisions of ASTM A449, Type 1 and ASTM A563, Grade C, respectively.

Assembly: The structure shall be assembled in accordance with the shop drawings provided by the manufacturer and per the manufacturer's recommendations. Bolts shall be tightened using an applied torque of between 100-300 ft.-lbs.

Installation: The structure shall be installed in accordance with the plans and specifications, the manufacturer's recommendations, and the AASHTO LRFD Specifications for Highway Bridges, Section 26 (Construction).

Backfill: The structure shall be backfilled using clean, well graded granular material that meets the requirements of AASHTO M 145 for soil classifications A-1-a. Backfill must be placed symmetrically on each side of the structure in 8-inch uncompacted lifts, with no side-to-side differential exceeding 24-inches. Each lift shall be compacted to a minimum 90% density per AASHTO T-180. Backfill limits shall be in accordance with the details shown on the plans.

Notes: Construction loads that exceed highway load limits are not allowed on the structure without approval from the Project Engineer.



Galvanized MULTI-PLATE removed from the Zinc Tank

Installation Recommendations

A successful installation is dependent on these five critical components being followed:

- Proper foundation
- Use of structural backfill
- 8" uncompacted lifts of backfill evenly placed on both sides of the structure with no side-to-side differential exceeding 24"
- Verification of backfill compaction
- Minimum cover over the structure

Required Elements

Satisfactory site preparation, trench excavation and bedding and backfill operations are essential to develop the strength of any flexible conduit. In order to obtain proper strength while preventing settlement, it is necessary that the soil envelope around the structure be of good granular material, properly placed, and carefully compacted.

Pipe-arch and underpass shapes pose special installation problems not found in other shapes. These two shapes generate high corner bearing pressures against the side fill and foundation. Therefore, special installation care must be implemented to achieve a composite soil structure.

A qualified Engineer should be engaged to design a proper foundation, adequate bedding, backfill, and erosion control.

Trench Excavation

If the adjacent embankment material is structurally adequate, the trench requires only a bottom clear width of the structure's span plus sufficient room for compaction equipment.

Bedding

Proper bedding preparation is critical to both structure performance and service life. The bedding should be constructed to a uniform line and grade to avoid distortions that may create undesirable stresses in the structure and/or rapid deterioration of the roadway. It should be free of rock formations, protruding stones, and frozen matter that may cause unequal settlement.

It is recommended that the bedding be a relatively loose granular material that is roughly shaped to fit the bottom of the structure, be a minimum of twice the corrugation depth in thickness and have a maximum particle size of one half the corrugation depth.

It should be noted that the bedding depth can vary based on the amount of cover and the shape of the structure's invert. The bedding should be shaped to match structures with flatter inverts.

Please reference the project specifications, drawing submittals and Contech's Assembly and Installation Guide for more information.

Backfill

Satisfactory backfill material, proper placement and compaction are key factors in obtaining maximum strength and stability. Compaction needs to be achieved under the haunches by carefully tamping a granular or select material.

The backfill material should be free of rocks, frozen lumps, and foreign material that can cause hard spots or decompose to create voids. Backfill material should be well graded granular material that meets the requirements of AASHTO M 145 for soil classifications A-1, A-2-4, A-2-5, or A-3. Backfill must be placed symmetrically on each side of the structure in eight-inch loose lifts. Each lift is to be compacted with no side-to-side differential exceeding 24-inches to a minimum 90% density per AASHTO T-180.

A high percentage of silt or fine sand in the native soils suggests the need for a *well graded* granular backfill material to prevent soil migration.

During backfill, only small tracked vehicles (20,000 lbs. or smaller) should be near the structure as fill progresses above the crown and to the finished grade. The Engineer and Contractor are cautioned that the minimum cover may need to be increased to handle temporary construction vehicle loads (heavier than the design highway load).

For more information, refer to ASTM A807 and AASHTO LRFD Bridge Construction Specifications Section 26.

Bolting

A well aligned plate fit is far better than a high torque. Bolts should be initially torqued to a minimum of 100 foot pounds and a maximum of 300 foot pounds.

Complete detailed assembly instructions and drawings are provided with each structure.

Erosion Control

During installation and prior to the construction of permanent erosion control and end treatment protection, special precautions may be necessary. The structure must be protected from unbalanced loads and from any structural loads or hydraulic forces that may bend or distort the unsupported ends of the structure. Erosion or washout of previously placed soil support must be prevented to ensure that the structure maintains its load capacity.

Aluminum Structural Plate

Lightweight and Lower Installed Cost

Contech Aluminum Structural Plate gives you many of the same advantages as steel MULTI-PLATE. It is also lightweight which adds to the ease of installation when compared to traditional concrete structures.

Aluminum structural plate is approximately one-fiftieth of the weight of reinforced concrete pipe in an equivalent size. This reduced weight factor minimizes assembly and equipment costs, helps gain access to remote sites and allows easy handling of long, preassembled structures.

Lower Job Site Unloading Costs

Lightweight plates and reinforcing ribs arrive at the job site in strapped and nested bundles. Individual plates and ribs are generally light enough to be handled by a small crew. Bundles can be handled with light-duty lifting equipment.

Lower Job Site Assembly Costs

Most structures contain plate and rib sizes that can be assembled without lifting equipment. As a quality assurance measure, at least one ring of plates for each order is plant-assembled and checked prior to shipment.

Aluminum Structural Plate can be manufactured in large sections with multiple radii in the same plate. This reduces the number of longitudinal seams, therefore, lowering assembly costs. Off-site assembly is an added feature of lightweight aluminum, with obvious cost-saving benefits.

Typical Aluminum Structural Plate applications include small bridges, grade separations, underpasses, culverts, stream enclosures, storm sewers and rehabilitating existing structures through relining.

National Specifications

Contech's Aluminum Structural Plate design meets or exceeds AASHTO LRFD Bridge Design Specifications, AASHTO Standard Specifications for Highway Bridges and ASTM. For listed specifications, please refer to page 27.

Description of Plates

Aluminum Structural Plate's corrugation pattern has a 9-inch pitch and 2-1/2 inch depth. The corrugations are perpendicular to the length of the structure.

Thickness. Nominal plate thicknesses are available from 0.125" to 0.250" in uniform increments of 0.025". Uncurved plates are available in 0.100" plate thickness.

Widths. Individual circumferential plate widths are noted in terms of N (N = 9.625" or 3 pi). Standard plates are fabricated in net widths of one "N" increments from:

8N (77.00") through 20N (192.50") (see Table 30).

The N nomenclature translates circumference directly into nominal diameter in inches. For example, two 10N plates give a diameter of 60" (2 x 10N x 3 pi), three 12N plates = 108" (3 x 12N x 3 pi), etc. Various plate lengths are used to obtain a specific structure shape and size.

Lengths. All standard plates have a net length of 4'-6". Longitudinal bolt holes at 4'-1/2" centers provide a standard 5.33 bolts per foot of longitudinal seams in two parallel rows at 1-3/4" centers. The outside crests of the end corrugations are punched for circumferential seam holes on center of 9.625" (or 3 pi).

Materials. Plates are fabricated from an aluminum alloy with material properties that conform to AASHTO M 219 and ASTM B209 specifications.



Lifting of Assembled Aluminum Pipe Arch



Standard Shapes



Aluminum Structural Plate Stream Crossing

Aluminum Box Culvert Triple Span



Aluminum Box Culvert Stream Crossing

Aluminum Structural Plate Pipe-Arch



Standard Plate Detail

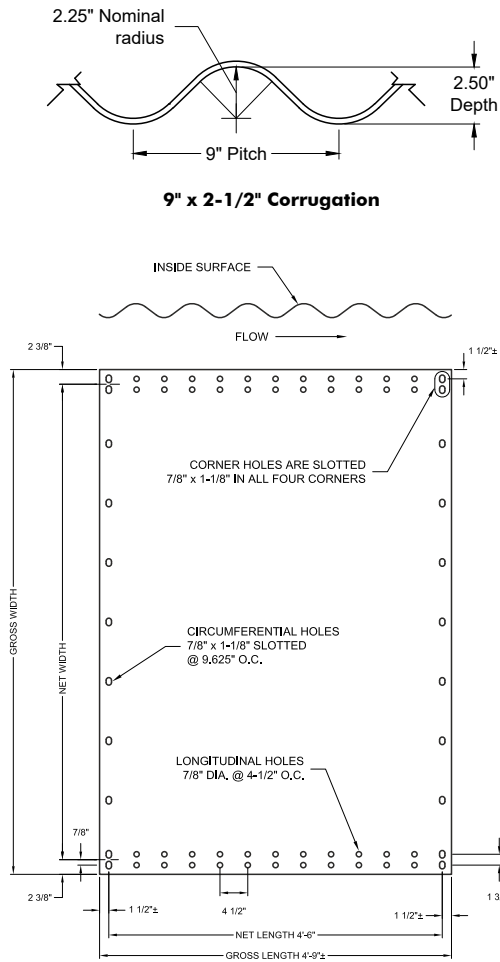

Standard Plate Detail

Aluminum Structural Plate Bolts and Nuts

3/4" diameter hot-dipped galvanized steel (specially heat-treated) fasteners meeting ASTM A307 or A449 specifications (with suitable nuts) are used to assemble structural plate structures. Aluminum fasteners are available for salt water installations and are provided upon request. Contact your local Contech representative.

The underside of the bolt head is uniformly rounded and ribbed to prevent bolt head rotation while tightening. Unlike conventional bolts, once the nut is finger tight, final tightening can typically be accomplished by one worker with an air driven impact wrench to 100-150 ft.-lbs. of torque.

In addition, one side of the nut is spherically formed to help align and center the fastener into the punched holes. The rounded side shall be placed against the structure.

Typical Bolt and Nut

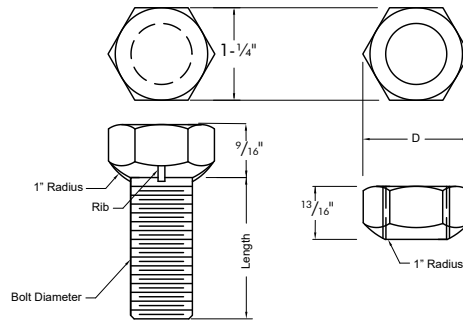

Proper Shingle at Invert

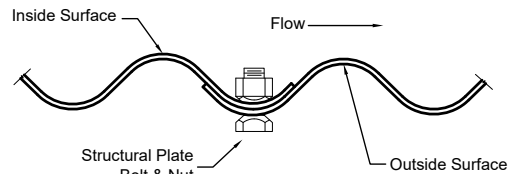

Note: The nut may be placed on either side of the plate.

TABLE 30. DETAILS OF UNCURVED ALSP PLATE

Plate "N"	Net Width (Inches)	Gross Width (Inches)	Plate Thickness (Inches)					
			Weight per Plate, lbs (without fasteners)					
			0.125	0.150	0.175	0.200	0.225	0.250
8	77-0	81-3/4	66	79	92	105	119	132
9	86-5/8	91-3/8	74	88	103	118	133	148
10	96-1/4	101-0	81	98	114	130	147	164
11	105-7/8	110-5/8	89	107	125	143	161	179
12	115-1/2	120-1/4	97	116	136	155	175	195
13	125-1/8	129-7/8	105	126	147	168	189	210
14	134-3/4	139-1/2	113	135	157	180	203	226
15	144-3/8	149-1/8	120	144	168	192	217	241
16	154-0	158-3/4	128	154	179	205	231	257
17	163-5/8	168-3/8	136	163	190	217	245	273
18	173-1/4	178-0	144	172	201	230	259	288
19	182-7/8	187-5/8	151	182	212	242	273	304
20	192-1/2	197-1/4	159	191	223	254	288	319

For ALSP, 1 N = 9.625"

TABLE 31. BOLT LENGTH AND USAGE

3/4" Diameter Bolt Lengths (Plate Only)				
Plate Thickness (Inches)	1 Plate	2 Plate Lap	3 Plate Lap	4 Plate Lap
0.125	N/A	1 1/4"	1 1/4"	1 1/4"
0.150-0.200	N/A	1 1/4"	1 1/2"	2"
0.225-0.250	N/A	1 1/2"	2"	N/A
3/4" Diameter Bolt Lengths (with Reinforcing Rib, if Required)				
Plate Thickness (Inches)	1 Plate	2 Plate Lap	3 Plate Lap	4 Plate Lap
0.125-0.175	1 1/4"	1 1/2"	2"	2"
0.200-0.250	1 1/2"	2"	2"	2"

Aluminum Structural Plate and Rib Technical Information

**TABLE 32. SECTION PROPERTIES OF PLATES ONLY
9" X 2-1/2" CORRUGATION**

Thickness (Inches)	Moment of Inertia (In. ⁴ /Ft.)	Section Modulus (In. ³ /Ft.)	Radius of Gyration (Inches)	Area of Section (In. ² /Ft.)	Ultimate Seam Strength (kip/ft.)
0.100	0.997	0.767	0.844	1.404	28.0
0.125	1.248	0.951	0.844	1.750	41.0
0.150	1.499	1.131	0.845	2.100	54.1
0.175	1.751	1.309	0.845	2.449	63.7
0.200	2.004	1.484	0.846	2.799	73.4
0.225	2.258	1.657	0.847	3.149	83.2
0.250	2.513	1.828	0.847	3.501	93.1

Notes:

1. Yield strength of aluminum is 24 ksi.
2. 0.100" Thickness can not be curved.

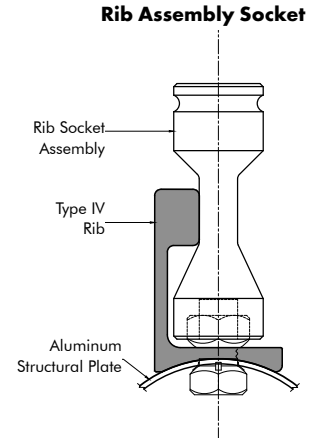
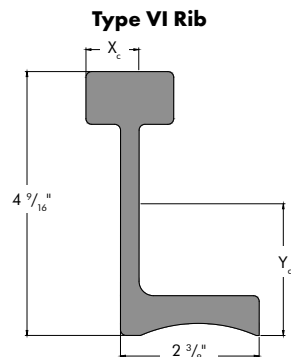
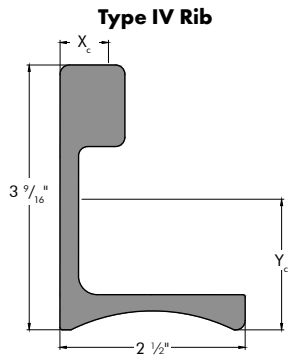
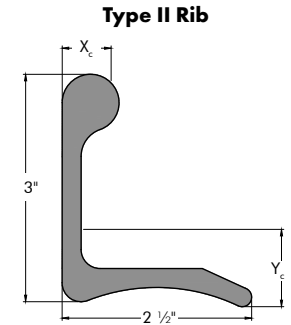

TABLE 33. PLATE & RIB COMPOSITE SECTION PROPERTIES

Rib Type	Spacing (Inches on Center)	Metal Thickness, Inches					
		0.125	0.150	0.175	0.200	0.225	0.250
		Plastic Moment Capacity, M_p (kip-ft./ft.)					
No Rib		2.65	3.18	3.71	4.24	4.77	5.30
Type II	@ 54	4.62	5.46	6.04	6.61	7.17	7.74
	@ 27	6.18	7.25	7.94	8.60	9.25	9.87
	@ 18	7.41	8.66	9.48	10.26	11.00	11.71
Type IV	@ 9	10.63	12.13	13.08	14.05	15.03	16.02
	@ 54	5.87	6.82	7.43	8.04	8.63	9.21
	@ 27	8.32	9.59	10.39	11.14	11.85	12.55
Type VI	@ 18	10.42	11.90	12.84	13.72	14.57	15.39
	@ 9	16.45	18.46	19.41	20.38	21.37	22.37
	@ 54	8.74	9.51	10.24	10.95	11.64	12.32
Type VI	@ 27	13.76	14.33	15.16	16.19	17.36	17.48
	@ 18	20.09	20.56	20.79	21.30	21.74	22.58
	@ 9	32.24	34.35	36.46	38.54	39.88	40.63

TABLE 34. SECTION PROPERTIES OF ALSP REINFORCING RIBS

	Type II Rib	Type IV Rib	Type VI Rib
Alloy	6061-T6	6061-T6	6061-T6
Area	1.71 in. ²	2.27 in. ²	3.62 in. ²
Center of Mass	$X_c = 0.645$ inches $Y_c = 1.02$ inches	$X_c = 0.652$ inches $Y_c = 1.76$ inches	$X_c = 0.91$ inches $Y_c = 2.27$ inches
Moment of Inertia	$I_{xc} = 1.802$ in. ⁴ $I_{yc} = 0.787$ in. ⁴	$I_{xc} = 3.555$ in. ⁴ $I_{yc} = 1.050$ in. ⁴	$I_{xc} = 9.700$ in. ⁴ $I_{yc} = 1.014$ in. ⁴
Radius of Gyration	$R_{xc} = 1.026$ inches $R_{yc} = 0.678$ inches	$R_{xc} = 1.251$ inches $R_{yc} = 0.680$ inches	$R_{xc} = 1.636$ inches $R_{yc} = 0.529$ inches
Section Modulus	$S_x = 1.046$ in. ³	$S_x = 1.90$ in. ³	$S_x = 4.38$ in. ³
Plastic Modulus	$Z_x = 1.705$ in. ³	$Z_x = 2.68$ in. ³	$Z_x = 5.66$ in. ³
Plastic Moment	$M_p = 4.97$ kip-ft.	$M_p = 7.81$ kip-ft.	$M_p = 16.52$ kip-ft.
Yield Strength	$F_y = 35$ ksi	$F_y = 35$ ksi	$F_y = 35$ ksi
Tensile Strength	$F_u = 38$ ksi	$F_u = 38$ ksi	$F_u = 38$ ksi
Rib Weight per Foot	2.055 lbs/ft	2.811 lbs/ft	4.356 lbs/ft



Aluminum Structural Plate – Handling Weights & Plate Make-Up

TABLE 35. APPROXIMATE HANDLING WEIGHT OF STRUCTURE (POUNDS PER FOOT)

Total N	Metal Thickness (Inches)						Round or Arch		Pipe-Arch	
	.125	.150	.175	.200	.225	.250	Bolts per Foot	Plates per Ring	Bolts per Foot	Plates per Ring
8	19	22	24	27	31	36	6.9	1	6.9	1
9	21	24	27	30	34	39	7.1	1	7.1	1
10	23	26	30	33	37	41	7.3	1	7.3	1
11	24	28	32	36	40	44	7.6	1	7.6	1
12	26	31	35	39	44	48	7.8	1	7.8	1
13	28	33	37	42	47	52	8.0	1	8.0	1
14	30	35	40	45	50	55	8.2	1	8.2	1
15	32	37	43	48	53	59	8.4	1	8.4	1
16	34	39	45	51	57	62	8.7	1	8.7	1
17	36	42	48	54	60	66	8.9	1	8.9	1
18	37	44	50	57	63	70	9.1	1	9.1	1
19	44	50	57	63	71	79	14.4	2	14.4	2
20	46	52	60	66	74	82	14.7	2	14.7	2
21	47	54	62	69	77	85	14.9	2	14.9	2
22	48	56	64	72	80	88	15.1	2	15.1	2
23	50	59	67	75	84	92	15.3	2	15.3	2
24	52	62	70	78	88	96	15.5	2	15.5	2
25	54	64	72	81	91	100	15.8	2	15.8	2
26	56	66	74	84	94	104	16.0	2	16.0	2
27	58	68	77	87	97	107	16.2	2	16.2	2
28	60	70	80	90	100	110	16.4	2	16.4	2
29	62	72	83	93	103	114	16.7	2	21.8	3
30	64	74	86	96	106	118	16.9	2	22.0	3
31	66	76	88	99	110	121	17.1	2	22.2	3
32	68	78	90	102	114	124	17.3	2	22.4	3
33	70	81	93	105	117	128	17.5	2	22.7	3
34	72	84	96	108	120	132	17.8	2	22.9	3
35	73	86	98	111	123	136	18.0	2	23.1	3
36	74	88	100	114	126	140	18.2	2	23.3	3
37	80	95	107	121	136	149	23.5	3	23.5	3
38	82	97	109	123	138	152	23.8	3	23.8	3
39	84	99	112	126	141	156	24.0	3	24.0	3
40	86	101	114	129	144	159	24.2	3	24.2	3
41	88	103	117	132	147	162	24.4	3	24.4	3
42	90	105	120	135	150	165	24.7	3	24.7	3
43	92	107	123	138	153	169	24.9	3	30.0	4
44	94	109	126	141	156	173	25.1	3	30.2	4
45	96	111	129	144	160	177	25.3	3	30.4	4
46	98	113	131	147	163	180	25.5	3	30.7	4
47	100	115	133	150	167	183	25.8	3	30.9	4
48	102	117	135	153	171	186	26.0	3	31.1	4
49	104	120	138	156	174	190	26.2	3	31.3	4
50	106	123	141	159	177	194	26.4	3	31.5	4
51	108	126	144	162	180	198	26.7	3	31.8	4
52	109	128	146	165	183	202	26.9	3	32.0	4
53	109	130	148	169	186	208	27.1	3	32.2	4
54	111	132	150	171	189	210	32.4	4	32.4	4
55	116	136	155	176	195	215	32.7	4	32.7	4
56	120	140	160	180	200	220	32.9	4	32.9	4
57	122	142	163	183	203	224	33.1	4	33.1	4
58	124	144	166	186	206	228	33.3	4	33.3	4
59	126	146	169	189	209	232	33.5	4	33.5	4
60	128	148	172	192	212	236	33.8	4	33.8	4
61	130	150	174	195	216	239	34.0	4	34.0	4
62	132	152	176	198	220	242	34.2	4	34.2	4
63	134	154	178	201	224	245	34.4	4	34.4	4
64	136	156	180	204	228	248	34.7	4	34.7	4
65	138	159	183	207	231	252	34.9	4	34.9	4
66	140	162	186	210	234	256	35.1	4	35.1	4
67	142	165	189	213	237	260	35.3	4	35.3	4
68	144	168	192	216	240	264	35.5	4	35.5	4
69	145	170	194	219	243	268	35.8	4	35.8	4
70	146	172	196	222	246	272	36.0	4	36.0	4
71	147	174	198	225	249	276	36.2	4	36.2	4
72	148	176	200	228	252	280	36.4	4	41.5	5
73	153	180	206	233	257	286	36.7	4	41.8	5
74	158	183	212	237	262	291	36.9	4	42.0	5
75	160	185	214	240	266	295	42.2	5	42.2	5
76	162	187	217	243	269	298	42.4	5	42.4	5
77	164	189	219	246	273	301	42.7	5	42.7	5
78	166	191	221	249	277	304	42.9	5	42.9	5
79	168	193	223	252	281	307	43.1	5	43.1	5
80	170	195	225	255	285	310	43.3	5	43.3	5
81	172	198	228	258	288	314	43.5	5	43.5	5
82	174	201	231	261	291	318	43.8	5	43.8	5
83	176	204	234	264	294	322	44.0	5	44.0	5
84	178	207	237	267	297	326	44.2	5	44.2	5

Notes:

1. Handling weights are approximate and include galvanized bolts and nuts.
2. Aluminum fasteners are available upon request.
3. To obtain the estimated total weight and bolt count per foot of the structure, use the Total N value of a structure (see Tables 39, 40, 41, 42, 44 and 46).
4. If a structure has reinforcing ribs, see Tables 36-38 for additional weight and bolt count.
5. For an arch, deduct 5.33 bolts per foot from column titled "Bolts per Foot."
6. On an arch, bolts and nuts for receiving angles are not included above.
7. Values in the column titled "Plates per Ring in a Structure" shall be shown on the assembly drawings provided.
7. For Ellipse and Underpass shapes, contact your local Contech representative.

Reinforcing Rib - Handling Weights

When circumferential ribs are used with Aluminum Structural Plate, they reinforce the structure to reduce minimum cover and provide additional stiffness. These circumferential ribs are bolted to the structure's crown and haunches (if applicable) at spacings of 9", 18", 27" or 54" centers.

TABLE 36. ADDED HANDLING WEIGHT AND ADDITIONAL BOLTS PER FOOT OF STRUCTURE FOR TYPE II REINFORCING RIB

Total N of Rib	9" o.c.		18" o.c.		27" o.c.		54" o.c.	
	Wt./Ft.	Bolts/ft	Wt./Ft.	Bolts/Ft.	Wt./Ft.	Bolts/Ft.	Wt./Ft.	Bolts/Ft.
5	15.7	7.3	7.7	3.3	5.0	2.0	2.3	0.7
6	18.6	8.6	9.1	3.9	5.9	2.3	2.7	0.8
7	21.5	9.8	10.5	4.4	6.8	2.7	3.2	0.9
8	24.3	11.0	11.9	5.0	7.7	3.0	3.6	1.0
9	27.2	12.2	13.3	5.6	8.7	3.3	4.0	1.1
10	30.1	13.4	14.7	6.1	9.6	3.7	4.5	1.2
11	32.9	14.7	16.1	6.7	10.5	4.0	4.9	1.3
12	35.8	15.9	17.5	7.2	11.4	4.3	5.3	1.4
13	38.7	17.1	18.9	7.8	12.3	4.7	5.7	1.6
14	41.5	18.3	20.3	8.3	13.2	5.0	6.2	1.7
15	44.4	19.6	21.7	8.9	14.2	5.3	6.6	1.8
16	47.3	20.8	23.1	9.4	15.1	5.7	7.0	1.9
17	50.2	22.0	24.5	10.0	16.0	6.0	7.4	2.0

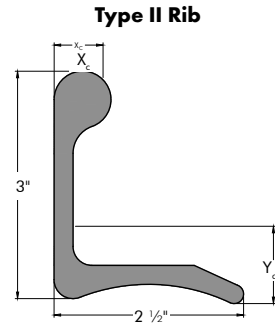

TABLE 37. ADDED HANDLING WEIGHT AND ADDITIONAL BOLTS PER FOOT OF STRUCTURE FOR TYPE IV REINFORCING RIB

Total N of Rib	9" o.c.		18" o.c.		27" o.c.		54" o.c.	
	Wt./Ft.	Bolts/ft	Wt./Ft.	Bolts/Ft.	Wt./Ft.	Bolts/Ft.	Wt./Ft.	Bolts/Ft.
5	20.0	7.3	9.8	3.3	6.4	2.0	3.0	0.7
6	23.7	8.6	11.6	3.9	7.6	2.3	3.6	0.8
7	27.4	9.8	13.4	4.4	8.8	2.7	4.2	0.9
8	31.0	11.0	15.2	5.0	10.0	3.0	4.7	1.0
9	34.7	12.2	17.1	5.6	11.2	3.3	5.3	1.1
10	38.4	13.4	18.9	6.1	12.4	3.7	5.9	1.2
11	42.1	14.7	20.7	6.7	13.5	4.0	6.4	1.3
12	45.8	15.9	22.5	7.2	14.7	4.3	7.0	1.4
13	49.4	17.1	24.3	7.8	15.9	4.7	7.5	1.6
14	53.1	18.3	26.1	8.3	17.1	5.0	8.1	1.7
15	56.8	19.6	27.9	8.9	18.3	5.3	8.7	1.8
16	60.5	20.8	29.7	9.4	19.5	5.7	9.2	1.9
17	64.1	22.0	31.5	10.0	20.7	6.0	9.8	2.0

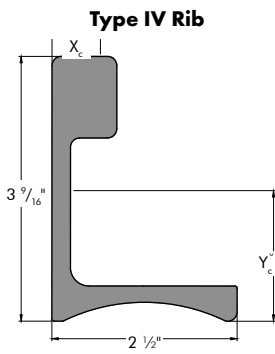
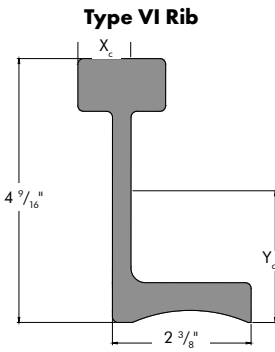

TABLE 38. ADDED HANDLING WEIGHT AND ADDITIONAL BOLTS PER FOOT OF STRUCTURE FOR TYPE VI REINFORCING RIB

Total N of Rib	9" o.c.		18" o.c.		27" o.c.		54" o.c.	
	Wt./Ft.	Bolts/ft	Wt./Ft.	Bolts/Ft.	Wt./Ft.	Bolts/Ft.	Wt./Ft.	Bolts/Ft.
5	28.8	7.3	14.2	3.3	9.4	2.0	4.5	0.7
6	34.1	8.6	16.9	3.9	11.1	2.3	5.3	0.8
7	39.4	9.8	19.5	4.4	12.8	2.7	6.2	0.9
8	44.8	11.0	22.1	5.0	14.6	3.0	7.0	1.0
9	50.1	12.2	24.7	5.6	16.3	3.3	7.8	1.1
10	55.4	13.4	27.4	6.1	18.0	3.7	8.7	1.2
11	60.8	14.7	30.0	6.7	19.8	4.0	9.5	1.3
12	66.1	15.9	32.7	7.2	21.5	4.3	10.4	1.4
13	71.4	17.1	35.3	7.8	23.2	4.7	11.2	1.6
14	76.8	18.3	37.9	8.3	25.0	5.0	12.0	1.7
15	82.1	19.6	40.6	8.9	26.7	5.3	12.9	1.8
16	87.4	20.8	43.2	9.4	28.5	5.7	13.7	1.9
17	92.8	22.0	45.8	10.0	30.2	6.0	14.5	2.0



- Notes:
1. Bolts and nuts are included in the tables above.
 2. For Total N of rib on a structure, see Tables 39, 40, 41, 42, 44 and 46.

Height of Cover and Details Tables for Aluminum Structural Plate

Instructions to Read Tables 39, 41, 43, 45 and 47:

The tables are presented for the designer's convenience in selecting metal thickness, reinforcing rib type and rib spacing for minimum cover applications. For structures with maximum covers greater than those shown in the table, heavier plate and rib combinations may be possible.

Minimum covers are also based on checking the plastic moment capacity. The required plastic moment of the plate and rib combination is compared to the plastic moment resistance. The unit weight of the backfill material is assumed to be 120 pcf.

To find the minimum material requirements for the aluminum structural plate structure:

1. Locate the structure required.
2. Select the cover in the top row that is equal to or less than that required for the project.
3. The table selection shows metal thickness, rib type, rib spacing and maximum cover.

**Example: .125-II-27
(17)**

.125" thick plate with Type II ribs at 27" on centers
with a maximum cover of 17'

Round, Vertical Ellipse

TABLE 39. ROUND & VERTICAL ELLIPSE 9" X 2-1/2" STRUCTURE DETAIL (HL-93 LOADING)

Diameter (Ft.-In.)	Round (Inches)	Round Approx. Area (Sq. Ft.)	Ellipse Dimensions (Ft.-In.)		Ellipse Approx. Area (Sq. Ft.)	Total N			Metal Thickness (Inches) — Reinforcing Rib Type Rib Spacing (Inches) (Maximum Cover — Ft.)					
			Span	Rise		Structure	Rib		Minimum Height of Cover (Feet)					
							Round	Ellipse	1.25	1.50	2.00	2.50	3.00	3.50
7-0	84	37.8	6-7	7-4	37.7	28			.175 (49)	.175 (49)	.175 (49)	.175 (49)	.175 (49)	.175 (49)
7-6	90	43.6	7-1	7-10	43.4	30			.250 (62)	.175 (42)	.175 (42)	.175 (42)	.175 (42)	.175 (42)
8-0	96	49.7	7-7	8-5	49.6	32				.200 (43)	.150 (32)	.150 (32)	.150 (32)	.150 (32)
8-6	102	56.3	8-1	8-11	56.2	34				.125-II-18 (21)	.150 (28)	.150 (28)	.150 (28)	.150 (28)
9-0	108	63.3	8-7	9-6	63.4	36				.125-II-18 (19)	.125-II-27 (19)	.150 (26)	.150 (26)	.150 (26)
9-6	114	70.7	9-1	10-0	70.5	38				.125-IV-18 (18)	.125-II-27 (18)	.150 (24)	.150 (24)	.150 (24)
10-0	120	78.5	9-7	10-7	78.3	40	10			.150-IV-18 (22)	.125-II-27 (16)	.150 (22)	.150 (22)	.150 (22)
10-6	126	86.7	10-0	11-1	86.5	42	10			.125-VI-18 (15)	.125-II-18 (15)	.125-II-27 (15)	.150 (20)	.150 (20)
11-0	132	95.4	10-6	11-7	95.1	44	10			.150-VI-18 (19)	.125-II-18 (13)	.125-II-27 (13)	.125-II-27 (13)	.125-II-54 (13)
11-6	138	104.4	11-0	12-2	104.1	46	10	11		.150-VI-18 (17)	.175-II-18 (21)	.125-II-27 (12)	.150-II-54 (17)	.150-II-54 (17)
12-0	144	113.9	11-6	12-8	113.5	48	12	11		.150-VI-18 (16)	.150-II-9 (16)	.150-II-27 (16)	.150-II-27 (16)	.150-II-27 (16)
12-6	150	123.7	11-10	13-1	123.4	50	12	12		.175-VI-9 (18)	.175-IV-18 (18)	.175-II-27 (18)	.175-II-27 (18)	.175-II-27 (18)
13-0	156	134.0	12-4	13-8	133.6	52	12	12		.175-VI-9 (17)	.175-VI-18 (17)	.175-IV-27 (17)	.175-II-27 (17)	.175-IV-54 (17)
13-6	162	144.7	12-9	14-2	144.2	54	12	13		.200-VI-9 (18)	.200-VI-18 (18)	.200-IV-27 (18)	.200-IV-54 (18)	.200-IV-54 (18)
14-0	168	155.7	13-3	14-8	155.3	56	12	13		.225-VI-9 (20)	.225-VI-18 (20)	.225-IV-27 (20)	.225-II-27 (20)	.225-II-27 (20)
14-6	174	167.2	13-9	15-3	166.8	58	13	14						
15-0	180	179.1	14-3	15-9	178.6	60	13	14						
15-6	186	191.4	14-9	16-3	190.9	62	14	15						
16-0	192	204.2	15-2	16-10	203.6	64	14	15						
16-6	198	217.3	15-9	17-5	216.7	66	15	16						
17-0	204	230.8	16-3	17-11	230.2	68	15	16						
17-6	210	247.8	16-8	18-6	244.1	70	16	16						
18-0	216	259.1	17-2	19-0	258.4	72	16	16						
18-6	222	273.9	17-8	19-7	273.1	74	16	17						
19-0	228	289.1	18-1	20-1	288.2	76	18	18						
19-6	234	304.7	18-8	20-7	303.8	78	18	17						
20-0	240	321.0	19-1	21-2	319.7	80	18	18						
20-6	246	337.0	19-7	21-8	336.1	82	18	19						
21-0	252	354.0	20-1	22-3	352.9	84	20	20						

Notes:

1. N = 9.625"
2. Dimensions are to inside corrugation crests and are subject to manufacturing tolerances.
3. For minimum covers that require reinforcing ribs, columns in the table show minimum lengths of rib.
4. Table based upon AASHTO LRFD Bridge Design Specification for Highway Bridges.
5. Per AASHTO 12.6.6.3, minimum cover is the vertical distance from the top of the corrugated structure to the bottom of flexible or top of rigid pavement.
6. Minimum cover for heavy off-road construction equipment loads must be checked.
7. Greater cover heights possible with heavier gage and rib combinations.

Horizontal Ellipse

TABLE 40. HORIZONTAL ELLIPSE 9" X 2-1/2" DETAILS

Structure Number	Span (Ft.-In.)	Rise (Ft.-In.)	Area (Sq. Ft.)	Approx.		Total N	
				R ₁ (Inches)	R ₂ (Inches)	Structure	Rib
10E6	9-2	6-8	48.4	68	32	32	11
11E6	9-11	7-0	54.3	75	32	34	12
12E6	10-7	7-3	59.6	81	32	36	13
12E7	10-11	7-11	68.0	81	37	38	13
13E6	11-4	7-6	66.2	88	32	38	14
13E7	11-8	8-3	74.8	88	37	40	14
13E8	12-0	8-11	83.8	88	43	42	14
14E6	12-1	7-9	72.8	95	32	40	15
14E7	12-5	8-6	82.0	95	37	42	15
14E8	12-9	9-2	91.5	95	43	44	15
15E6	12-10	8-1	79.7	102	32	42	16
15E7	13-2	8-9	89.4	102	37	44	16
15E8	13-6	9-6	99.4	102	43	46	16
16E6	13-7	8-4	86.8	109	32	44	17
16E7	13-11	9-0	97.1	109	37	46	17
16E8	14-3	9-9	107.6	109	43	48	17
16E9	14-7	10-5	118.5	109	49	50	17
16E10	14-11	11-2	129.7	109	54	52	17



Installation of Aluminum Horizontal Ellipses

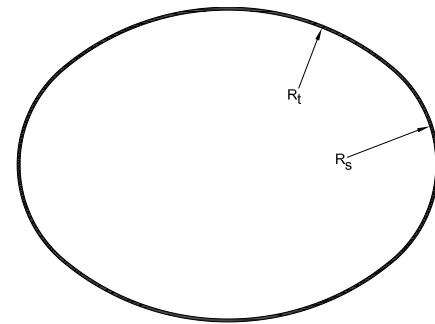

Horizontal Ellipse

Aluminum Structural Plate

TABLE 41. HORIZONTAL ELLIPSE 9" X 2-1/2" STRUCTURES (HL-93 LOADING)

Structure Number	Span (Ft.-In.)	Rise (Ft.-In.)	Total N		Metal Thickness (Inches) — Reinforcing Rib Type					
					Rib Spacing (Inches) Maximum Cover (Feet)					
			Structure	Rib	1.25	1.50	2.00	2.50	3.00	3.50
10E6	9-2	6-8	32	11	.125-II-9	.125-II-18	.125	.125	.125	.125
11E6	9-11	7-0	34	12	(12)	(12)	(12)	(12)	(12)	(12)
12E6	10-7	7-3	36	13	.150-II-9	.125-II-18	.125-II-27	.125	.125	.125
12E7	10-11	7-11	38	13	(12)	(12)	(12)	(12)	(12)	(12)
13E6	11-4	7-6	38	14	.125-IV-9	.125-IV-18	.125-II-27	.125	.125	.125
13E7	11-8	8-3	40	14	(9)	(9)	(9)	(9)	(9)	(9)
13E8	12-0	8-11	42	14						
14E6	12-1	7-9	40	15						
14E7	12-5	8-6	42	15	.150-IV-9	.150-IV-18	.125-II-27	.150	.125	.125
14E8	12-9	9-2	44	15	(9)	(9)	(9)	(9)	(9)	(9)
15E6	12-10	8-1	42	16						
15E7	13-2	8-9	44	16	.150-VI-9	.150-VI-18	.150-IV-18	.125-II-27	.150	.150
15E8	13-6	9-6	46	16	(9)	(9)	(9)	(9)	(9)	(9)
16E6	13-7	8-4	44	17						
16E7	13-11	9-0	46	17						
16E8	14-3	9-9	48	17	.150-VI-9	.150-VI-18	.150-IV-27	.150-II-27	.175	.175
16E9	14-7	10-5	50	17	(9)	(9)	(9)	(9)	(9)	(9)
16E10	14-11	11-2	52	17						

Notes:

1. Table based upon AASHTO LRFD Bridge Design Specification for Highway Bridges.
2. Per AASHTO 12.6.6.3, minimum cover is the vertical distance from the top of the corrugated structure to the bottom of flexible or top of rigid pavement.
3. Minimum cover for heavy off-road construction equipment loads must be checked.
4. Minimum cover heights < span/8 determined by moment capacity analysis.
5. Maximum cover based upon a suggested minimum allowable corner bearing capacity of 4,000 psf.

Pipe-Arch

TABLE 42. PIPE-ARCH 9" X 2-1/2" DETAILS

Span (Ft.-In.)	Rise (Ft.-In.)	Approx Area (Sq. Ft.)	Inside Radius (Inches)		Arc Length N			Total N	
			Crown (R _c)	Invert (R _i)	Crown	Haunch	Invert	Structure	Rib
Haunch Radius (R_h) = 31.75"									
6-7	5-8	29.6	41.5	69.9	8	7	3	25	
6-11	5-9	31.9	43.7	102.9	9	7	3	26	
7-3	5-11	34.3	45.6	188.3	10	7	3	27	
7-9	6-0	36.8	51.6	83.8	9	7	5	28	
8-1	6-1	39.3	53.3	108.1	10	7	5	29	
8-5	6-3	41.9	54.9	150.1	11	7	5	30	
8-10	6-4	44.5	63.3	93.0	10	7	7	31	11
9-3	6-5	47.1	64.4	112.6	11	7	7	32	10
9-7	6-6	49.9	65.4	141.6	12	7	7	33	11
9-11	6-8	52.7	66.4	188.7	13	7	7	34	10
10-3	6-9	55.5	67.4	278.8	14	7	7	35	11
10-9	6-10	58.4	77.5	139.6	13	7	9	36	12
11-1	7-0	61.4	77.8	172.0	14	7	9	37	11
11-5	7-1	64.4	78.2	222.0	15	7	9	38	12
11-9	7-2	67.5	78.7	309.5	16	7	9	39	13
12-3	7-3	70.5	90.8	165.2	15	7	11	40	14
12-7	7-5	73.7	90.5	200.0	16	7	11	41	13
12-11	7-6	77.0	90.4	251.7	17	7	11	42	14
13-1	8-2	83.0	88.8	143.6	18	6	13	43	13
13-1	8-4	86.8	81.7	300.8	21	6	11	44	14
13-11	8-5	90.3	100.4	132.0	18	6	15	45	13
14-0	8-7	94.2	90.3	215.7	21	6	13	46	14
13-11	9-5	101.5	86.2	159.3	23	5	14	47	14
14-3	9-7	105.7	87.2	176.3	24	5	14	48	13
14-8	9-8	109.9	90.9	166.2	24	5	15	49	13
14-11	9-10	114.2	91.8	183.0	25	5	15	50	14
15-4	10-0	118.6	95.5	173.0	25	5	16	51	14
15-7	10-2	123.1	96.4	189.6	26	5	16	52	15
16-1	10-4	127.6	100.2	179.7	26	5	17	53	15
16-4	10-6	132.3	101.0	196.1	27	5	17	54	14
16-9	10-8	136.9	105.0	186.5	27	5	18	55	16
17-0	10-10	141.8	105.7	202.5	28	5	18	56	17
17-3	11-0	146.7	106.5	221.7	29	5	18	57	17
17-9	11-2	151.6	110.4	208.9	29	5	19	58	16
18-0	11-4	156.7	111.1	227.3	30	5	19	59	17
18-5	11-6	161.7	115.8	215.3	30	5	20	60	17
18-8	11-8	167.0	115.8	233.7	31	5	20	61	18
19-2	11-9	172.2	119.9	221.5	31	5	21	62	18
19-5	11-11	177.6	120.5	239.7	32	5	21	63	19
19-10	12-1	182.9	124.7	227.7	32	5	22	64	19
20-1	12-3	188.5	125.2	245.3	33	5	22	65	18
20-1	12-6	194.4	122.5	310.8	35	5	21	66	18
20-10	12-7	199.7	130.0	251.2	34	5	23	67	19
21-1	12-9	205.5	130.5	270.9	35	5	23	68	19
21-6	12-11	211.2	134.8	257.3	35	5	24	69	20
Haunch Radius (R_h) = 47.0"									
20-1	13-11	216.6	124.0	225.4	34	7	20	68	19
20-7	14-3	224.0	126.2	257.6	36	7	20	70	19
21-5	14-7	241.5	133.0	238.6	36	7	22	72	19
21-11	14-11	254.7	135.0	270.0	38	7	22	74	19

Notes:

1. N = 9.625"
2. Dimensions are to inside corrugation crests and are subject to manufacturing tolerances.
3. For minimum covers that require reinforcing ribs, columns in the table show minimum lengths of rib.
4. The "Arc Length N" column indicates the peripheral length of each arc segment of the shape. The actual plate make-up of the ring will vary since plates are double-curved from one arc to another.

TABLE 43. PIPE-ARCH 9" X 2-1/2" STRUCTURES (HL-93 LOADING)

Span (Ft.-In.)	Rise (Ft.-In.)	Approx. Area (Sq. Ft.)	Metal Thickness (Inches) — Reinforcing Rib Type Rib Spacing (Inches) (Maximum Cover — Ft.)					
			Minimum Height of Cover (Feet)					
			1.25	1.50	2.00	2.50	3.00	3.50
6-7	5-8	29.6	.175	.150	.150	.150	.150	.150
6-11	5-9	31.9	(24)	(24)	(24)	(24)	(24)	(24)
7-3	5-11	34.3	.250	.150	.150	.150	.150	.150
7-9	6-0	36.8	(18)	(18)	(18)	(18)	(18)	(18)
8-1	6-1	39.3						
8-5	6-3	41.9		.200	.150	.150	.150	.150
8-10	6-4	44.5		(16)	(16)	(16)	(16)	(16)
9-3	6-5	47.1	.125-II-9	.125-II-27	.125	.125	.125	.125
9-7	6-6	49.9	(15)	(15)	(15)	(15)	(15)	(15)
9-11	6-8	52.7						
10-3	6-9	55.5		.150-II-18	.125-II-27	.125	.125	.125
10-9	6-10	58.4		(13)	(13)	(13)	(13)	(13)
11-1	7-0	61.4						
11-5	7-1	64.4		.125-II-9	.125-II-27	.125	.125	.125
11-9	7-2	67.5		(13)	(13)	(13)	(13)	(13)
12-3	7-3	70.5			.125-II-27	.150	.125	.125
12-7	7-5	73.7			(11)	(11)	(11)	(11)
12-11	7-6	77.0						
13-1	8-2	83.0						
13-1	8-4	86.8						
13-11	8-5	90.3			.125-II-18	.125-II-27	.125	.125
14-0	8-7	94.2			(10)	(10)	(10)	(10)
13-11	9-5	101.5						
14-3	9-7	105.7			.150-II-18	.125-II-27	.125	.125
14-8	9-8	109.9			(9)	(9)	(9)	(9)
14-11	9-10	114.2						
15-4	10-0	118.6			.125-II-9	.125-II-27	.150	.125
15-7	10-2	123.1			(8)	(8)	(8)	(8)
16-1	10-4	127.6						
16-4	10-6	132.3						
16-9	10-8	136.9			.125-VI-27	.125-II-18	.125-II-54	.150
17-0	10-10	141.8			(7)	(7)	(7)	(7)
17-3	11-0	146.7						
17-9	11-2	151.6						
18-0	11-4	156.7			.125-VI-27	.125-IV-27	.125-IV-54	.175
18-5	11-6	161.7			(7)	(7)	(7)	(7)
18-8	11-8	167.0						
19-2	11-9	172.2			.150-IV-9	.150-IV-27	.150-IV-54	.200
19-5	11-11	177.6			(6)	(6)	(6)	(6)
19-10	12-1	182.9						
20-1	12-3	188.5			.175-IV-9	.175-IV-27	.175-IV-54	.225
20-1	12-6	194.4			(6)	(6)	(6)	(6)
20-1	13-11	216.6						
20-7	14-3	224.0						
20-10	12-7	199.7						
21-1	12-9	205.5			.150-VI-18	.175-IV-18	.150-IV-54	.150-IV-54
21-6	12-11	211.2			(7)	(7)	(7)	(7)
21-5	14-7	241.5						
21-11	14-11	254.7						

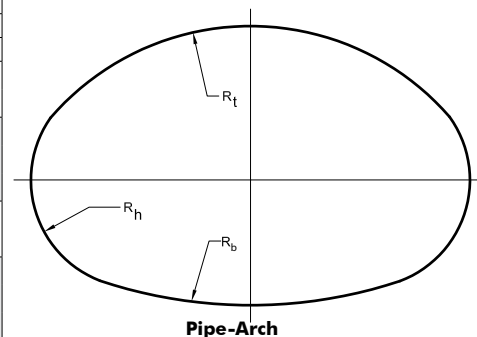

Aluminum Structural Plate

Sidefill and Foundation Design

Horizontal ellipse, pipe-arch, and underpass shapes generate high bearing pressures against the sidefill and foundation in the areas of the smaller radius haunches. The height of cover is directly affected by these bearing pressures. The surrounding soil and foundation, therefore, must be checked to ensure that they are adequate to react against these pressures without excessive strain.

Notes:

1. Table based upon AASHTO LRFD Bridge Design Specification for Highway Bridges.
2. Per AASHTO 12.6.6.3, minimum cover is the vertical distance from the top of the corrugated structure to the bottom of flexible or top of rigid pavement.
3. Minimum cover for heavy off-road construction equipment loads must be checked.
4. Minimum cover heights < span/8 determined by moment capacity analysis.
5. Maximum cover based upon a suggested minimum allowable corner bearing capacity of 4,000 psf.

Single Radius Arch

TABLE 44. ARCH 9" X 2-1/2" DETAILS

Span (Ft.-In.)	Rise (Ft.-In.)	Approx Area (Sq. Ft.)	Radius (Inches)	Rise/ Span Ratio	Total N		Span (Ft.-In.)	Rise (Ft.-In.)	Approx Area (Sq. Ft.)	Radius (Inches)	Rise/ Span Ratio	Total N	
					Structure	Rib						Structure	Rib
7-0	2-4	12.0	45.25	.34	11		17-0	5-3	63.5	114.25	.31	26	16
	2-10	14.8	43.00	.40	12			6-3	77.9	107.00	.37	28	16
	3-3	17.5	42.00	.46	13			7-2	91.7	103.50	.42	30	16
	3-8	20.3	42.00	.52	14			8-0	105.2	102.25	.47	32	16
8-0	2-11	17.0	50.50	.36	13		18-0	8-10	118.7	102.00	.52	34	16
	3-4	20.2	48.75	.42	14			5-9	74.8	118.75	.32	28	18
	4-2	26.4	48.00	.52	16			6-9	89.9	112.50	.38	30	18
9-0	2-11	19.1	59.00	.33	14	8	19-0	7-8	104.5	109.25	.43	32	18
	3-10	26.3	54.50	.43	16			8-6	118.8	108.25	.47	34	18
	4-8	33.4	54.00	.50	18			8-11	125.9	108.00	.50	35	17
10-0	3-6	25.3	64.00	.35	16	10	20-0	6-4	86.9	123.50	.33	30	18
	4-5	33.3	60.50	.44	18	10		7-4	102.7	118.00	.38	32	18
	5-2	41.2	60.00	.52	20	9		8-2	118.0	115.25	.43	34	18
11-0	3-6	27.8	72.75	.32	17	11	21-0	9-0	133.2	114.25	.48	36	18
	4-6	36.8	67.50	.41	19	11		9-5	140.7	114.00	.50	37	17
	5-9	49.9	66.00	.52	22	10		6-4	91.2	132.50	.32	31	19
12-0	4-1	35.3	77.50	.34	19	11	22-0	7-4	108.4	125.75	.37	33	19
	5-0	45.0	73.25	.42	21	11		8-3	124.4	122.25	.41	35	19
	6-3	59.3	72.00	.52	24	12		9-2	140.4	120.50	.46	37	19
13-0	4-1	38.1	86.50	.31	20	12	23-0	10-0	156.3	120.00	.50	39	19
	5-1	48.9	80.50	.39	22	12		10-4	164.2	120.00	.52	40	20
	5-11	59.3	78.25	.46	24	12		6-4	95.4	142.00	.30	32	20
14-0	6-9	69.5	78.00	.52	26	12	24-0	7-5	113.5	133.75	.35	34	20
	4-8	46.9	91.25	.33	22	14		8-4	130.7	129.25	.40	36	20
	5-7	58.4	86.00	.40	24	14		9-3	147.6	127.50	.44	38	20
	6-5	69.5	84.25	.46	26	14		10-1	164.3	126.00	.48	40	20
15-0	7-3	80.6	84.00	.52	28	14	25-0	10-10	181.0	126.00	.52	42	20
	4-8	50.0	100.50	.31	23	15		6-11	109.2	142.25	.31	34	20
	5-8	62.6	93.50	.38	25	15		7-11	127.9	139.00	.36	36	20
	6-7	74.7	91.00	.44	27	15		8-11	146.0	135.00	.40	38	20
	7-5	86.5	90.00	.49	29	15		9-9	163.6	133.00	.44	40	20
16-0	7-9	92.5	90.00	.52	30	14	26-0	10-7	181.1	132.00	.48	42	20
	5-3	60.0	105.00	.32	25	15		11-5	198.6	132.00	.52	44	20
	6-2	73.3	99.25	.39	27	15		7-6	123.8	151.00	.33	36	20
	7-1	86.2	96.75	.44	29	15		8-0	133.6	147.25	.35	37	21
	7-11	98.9	96.00	.49	31	15		8-6	143.2	144.50	.37	38	20
8-3	105.2	96.00	.52	32	14	27-0	8-11	152.7	142.25	.39	39	21	
							9-5	162.0	140.75	.41	40	20	
							9-10	171.3	139.50	.43	41	21	
							10-3	180.5	139.00	.45	42	20	
							10-8	189.6	138.25	.47	43	21	
							11-1	198.8	138.0	.48	44	20	
							11-6	207.9	138.00	.50	45	21	
						11-11	217.1	138.00	.52	46	20		

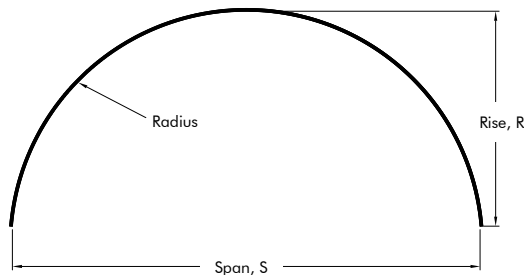

Single Radius Arch

Notes:

1. N = 9.625"
2. Dimensions to inside corrugation crests are subject to manufacturing tolerances.
3. For minimum covers that require reinforcing ribs, columns in the table show minimum lengths of rib.
4. Arch shapes shown are single radius with a rise/span ratio of 0.30 or greater.

TABLE 45. ARCH 9" X 2-1/2" STRUCTURES (HL-93 LOADING)

Span (Ft.-In.)	Rise (Ft.-In.)	Approx Area (Sq. Ft.)	Metal Thickness (Inches) — Reinforcing Rib Type Rib Spacing (Inches) (Maximum Cover — Ft.)					
			Minimum Height of Cover (Feet)					
			1.25	1.50	2.00	2.50	3.00	3.50
7-0	2-4	12.0	.175	.175	.175	.175	.175	.175
	2-10	14.8	(45)	(45)	(45)	(45)	(45)	(45)
	3-3	17.5						
	3-8	20.3						
8-0	2-11	17.0	.250	.175	.175	.175	.175	.175
	3-4	20.2	(63)	(42)	(42)	(42)	(42)	(42)
	4-2	26.4						
9-0	2-11	19.1		.200	.150	.150	.150	.150
	3-10	26.3		(45)	(32)	(32)	(32)	(32)
	4-8	33.4						
10-0	3-6	25.3	.125-II-9	.125-II-18	.125	.125	.125	.125
	4-5	33.3	(21)	(21)	(21)	(21)	(21)	(21)
	5-2	41.2						
11-0	3-6	27.8	.150-II-9	.125-II-18	.125-II-27	.125	.125	.125
	4-6	36.8	(26)	(19)	(19)	(19)	(19)	(19)
	5-9	49.9						
12-0	4-1	35.3	.225-II-9	.125-II-9	.125-II-27	.125	.125	.125
	5-0	45.0	(37)	(18)	(18)	(18)	(18)	(18)
	6-3	59.3						
13-0	4-1	38.1		.150-II-9	.125-II-27	.150	.125	.125
	5-1	48.9		(22)	(16)	(22)	(16)	(16)
	5-11	59.3						
	6-9	69.5						
14-0	4-8	46.9		.200-II-9	.125-II-18	.175	.125	.125
	5-7	58.4		(28)	(15)	(24)	(15)	(15)
	6-5	69.5						
	7-3	80.6						
15-0	4-8	50.0		.250-II-9	.125-II-9	.125-II-27	.125	.125
	5-8	62.6		(33)	(13)	(13)	(13)	(13)
	6-7	74.7						
	7-5	86.5						
	7-9	92.5						
16-0	5-3	60.0		.150-IV-9	.125-II-9	.125-II-27	.150	.125
	6-2	73.3		(17)	(12)	(12)	(17)	(12)
	7-1	86.2						
	7-11	98.9						
	8-3	105.2						
17-0	5-3	63.5		.150-VI-18	.225-II-18	.150-II-27	.175	.150
	6-3	77.9		(16)	(26)	(16)	(19)	(16)
	7-2	91.7						
	8-0	105.2						
	8-10	118.7						
18-0	5-9	74.8		.150-VI-9	.175-IV-18	.125-IV-27	.200	.175
	6-9	89.9		(15)	(18)	(11)	(21)	(18)
	7-8	104.5						
	8-6	118.8						
	8-11	125.9						
19-0	6-4	86.9		.150-VI-9	.125-VI-18	.125-IV-27	.125-II-27	.175
	7-4	102.7		(14)	(10)	(10)	(10)	(17)
	8-2	118.0						
	9-0	133.2						
	9-5	140.7						
20-0	6-4	91.2		.150-VI-9	.150-VI-9	.150-IV-27	.150-II-27	.200
	7-4	108.4		(13)	(13)	(13)	(13)	(19)
	8-3	124.4						
	9-2	140.4						
	10-0	156.3						
21-0	6-4	95.4		.175-VI-9	.175-VI-18	.175-IV-18	.175-II-27	.225
	7-5	113.5		(15)	(15)	(15)	(15)	(20)
	8-4	130.7						
	9-3	147.6						
	10-1	164.3						
	10-10	181.0						
22-0	6-11	109.2		.200-VI-9	.175-VI-18	.175-IV-18	.175-IV-27	.250
	8-0	127.9		(17)	(14)	(14)	(14)	(22)
	8-11	146.0						
	9-9	163.6						
	10-7	181.1						
	11-5	198.6						
23-0	7-6	123.8		.225-VI-9	.225-VI-18	.225-IV-18	.225-IV-54	.250-II-27
	8-0	133.6		(18)	(18)	(18)	(18)	(21)
	8-6	143.2						
	8-11	152.7						
	9-5	162.0						
	9-10	171.3						
	10-3	180.5						
	10-8	189.6						
	11-1	198.8						
	11-6	207.9						
	11-11	217.1						

Notes:

1. Table based upon AASHTO LRFD Bridge Design Specification for Highway Bridges.
2. Per AASHTO 12.6.6.3, minimum cover is the vertical distance from the top of the corrugated structure to the bottom of flexible or top of rigid pavement.
3. Minimum cover for off highway construction loads must be checked.
4. Minimum cover heights < span/8 determined by moment capacity analysis.
5. Greater cover heights possible with other plate thickness/rib combinations.
6. Footing reactions are available upon request.

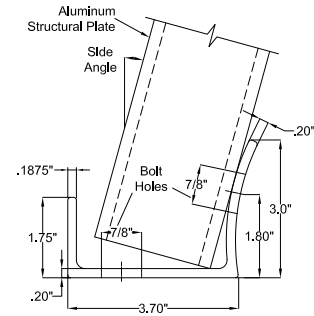

Aluminum Receiving Channel

Weight is equal to 2 lbs per foot per side.

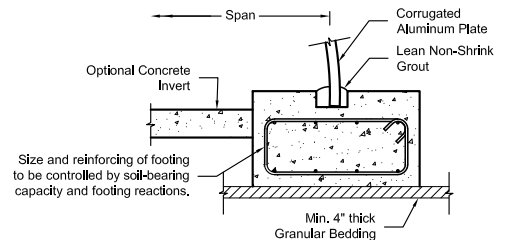

Slotted Concrete Footing

For a single radius arch, the dimensions of the keyway shall be a minimum of 4" height x 8" wide.

Underpass

TABLE 46. PEDESTRIAN/ANIMAL UNDERPASS DETAILS

Span (Ft.-In.)	Rise (Ft.-In.)	Approx. Area (Sq. Ft.)	Inside Radius (Inches)				Arc Length (Inches)				Total N	
			Crown (R _c)	Side (R _s)	Haunch (R _h)	Invert (R _i)	Crown	Side	Haunch	Bottom	Structure	Rib
Junior Underpasses												
6-1	5-9	28.0	31.8	48.2	31.8		43.0	20.5	68.6	9.2	24	
6-3	6-1	30	31.8	51.3	31.8		50.2	28.6	60.7	11.1	25	
6-3	6-6	32	31.8	55.0	31.8		56.5	36.8	53.9	11.6	26	
6-2	6-11	34	31.8	71.3	31.8		70.4	38.0	51.3	10.2	27	
6-4	7-3	37	31.8	72.4	31.8		67.3	45.0	50.0	11.6	28	
6-3	7-9	39	31.8	74.7	31.8		69.2	54.0	45.7	9.8	29	
6-5	8-1	42	31.8	75.8	31.8		66.9	60.5	44.4	11.3	30	
Standard Underpasses												
12-1	11-0	107.5	70	83	38	133	13	8	4	10	47	10
12-10	11-2	116.6	75	83	38	144	14	8	4	11	49	11
13-0	12-0	126.7	74	93	38	152	14	9	4	11	51	11
13-8	12-4	136.7	78	96	38	158	15	9	4	12	53	12
14-0	12-11	147.4	79	102	38	174	15	10	4	12	55	12
14-6	13-5	156.7	76	144	38	192	16	9	5	13	57	12
14-9	14-1	169.8	81	118	38	182	16	11	4	13	59	12
15-5	14-5	179.2	80	158	38	217	17	10	5	14	61	13
15-7	15-2	193.6	85	132	38	195	17	12	4	14	63	13
16-3	15-6	206.1	89	135	38	201	18	12	4	15	65	13
16-5	16-0	216.0	87	170	38	330	19	12	5	14	67	13
16-8	16-4	222.3	86	188	38	277	19	12	5	15	68	13
17-3	17-1	238.4	89	182	48	219	19	12	6	15	70	16
18-5	16-11	252.0	99	159	48	262	20	12	6	16	72	17
19-0	17-3	266.0	103	166	48	264	21	12	6	17	74	18
19-7	17-7	280.2	107	160	48	315	21	13	6	17	76	18
20-5	17-9	294.4	113	158	48	336	22	13	6	18	78	19

Notes:

1. N = 9.625"
2. Dimensions are to inside corrugation crests and are subject to manufacturing tolerances. The designer should allow sufficient clearance for manufacturing tolerances and installation deflection.
3. To determine proper gage, use information on Page 59, Table 47.
4. The "Arc Length N" column indicates the peripheral length of each arc segment of the shape. The actual plate make-up of the ring will vary since plates are double-curved from one arc to another.

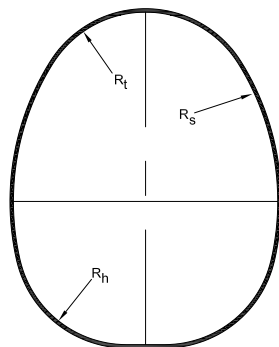

Junior Underpass

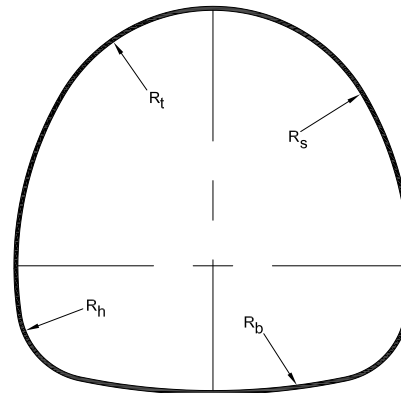

Standard Underpass

TABLE 47. UNDERPASS STRUCTURES (HL-93 LOADING)

Span (Ft.-In.)	Rise (Ft.-In.)	Approx. Area (Sq. Ft.)	Metal Thickness (Inches) — Reinforcing Rib Type Rib Spacing (Inches) (Maximum Cover — Ft.)					
			Minimum Height of Cover (Feet)					
			1.25	1.50	2.00	2.50	3.00	3.50
Junior Underpasses								
6-1	5-9	28	.150	.150	.150	.150	.150	.150
6-3	6-1	30	(32)	(32)	(32)	(32)	(32)	(32)
6-3	6-6	32						
6-2	6-11	34						
6-4	7-3	37						
6-3	7-9	39						
6-5	8-1	42						
Standard Underpasses								
12-1	11-0	107.5		.125-IV-18 (16)	.125-II-27 (16)	.125 (16)	.125 (16)	.125 (16)
12-10	11-2	116.6		.150-II-9 (15)	.125-II-27 (15)	.150 (15)	.125 (15)	.125 (15)
13-0	12-0	126.7		.125-VI-18 (14)	.125-II-18 (14)	.175 (14)	.150 (14)	.150 (14)
13-8	12-4	136.7		.125-VI-18 (14)	.125-II-18 (14)	.175 (14)	.150 (14)	.150 (14)
14-0	12-11	147.4		.125-VI-18 (13)	.125-II-18 (13)	.200 (13)	.150 (13)	.150 (13)
14-6	13-5	156.7		.125-VI-18 (12)	.125-VI-27 (12)	.125-II-27 (12)	.175 (12)	.175 (12)
14-9	14-1	169.8		.125-VI-18 (11)	.125-VI-27 (11)	.150-II-27 (11)	.150-II-27 (11)	.200 (11)
15-5	14-5	179.2		.150-VI-9 (14)	.150-VI-18 (14)	.150-IV-27 (14)	.150-IV-27 (14)	.150-VI-54 (14)
15-7	15-2	193.6		.175-VI-9 (12)	.175-VI-18 (12)	.175-IV-27 (12)	.150-IV-27 (12)	.150-IV-27 (12)
16-3	15-6	206.1						
16-5	16-0	216.0						
16-8	16-4	222.3						
17-3	17-1	238.4						
18-5	16-11	252.0						
19-0	17-3	266.0						
19-7	17-7	280.2						
20-5	17-9	294.4						

Notes:

1. Table based upon AASHTO LRFD Bridge Design Specification for Highway Bridges.
2. Per AASHTO 12.6.6.3, minimum cover is the vertical distance from the top of the corrugated structure to the bottom of flexible or top of rigid pavement.
3. Minimum cover for heavy off-road construction equipment loads must be checked.
4. Minimum cover heights < span/8 determined by moment capacity analysis.
5. Maximum cover based upon a suggested minimum allowable corner bearing capacity of 4,000 psf.



Assembly of Aluminum Structural Plate with Headwalls

Aluminum Structural Plate

Aluminum Structural Plate Project Specification

Scope: This specification covers the manufacture and installation of the Aluminum Structural Plate structure detailed in the plans.

Material: The Aluminum Structural Plate structure shall consist of plates and appurtenant items as shown on the plans and shall conform to the requirements of AASHTO M 219 and ASTM B746. The corrugated plate (and ribs if required) shall be curved and bolt hole punched at the plant. Plate thickness and rib spacings shall be as indicated on the plans. All manufacturing processes including corrugating, punching, and curving, shall be performed within the United States.

Bolts and suitable nuts shall conform to the requirements of ASTM A307 or A449 for steel fasteners or ASTM F467 and F468 for aluminum fasteners.

Assembly: The structure shall be assembled in accordance with the manufacturer's shop drawings and recommendations. Bolts shall be tightened using an applied torque between 100-150 ft.-lbs..

Installation: The structure shall be installed in accordance with the plans and specifications, the manufacturer's recommendations and the AASHTO LRFD Bridge Construction Specifications, Section 26.

Backfill: The structure shall be backfilled using clean, well graded granular material that meets the requirements of AASHTO M 145 for soil classifications A-1, A-2-4, A-2-5, or A-3. Backfill must be placed symmetrically on each side of the structure in 8-inch uncompacted lifts with no side-to-side differential exceeding 24-inches. Each lift shall be compacted to a minimum 90% density per AASHTO T-180.

Note: Construction loads that exceed highway load limits are not allowed on the structure without approval from the Project Engineer.



Assembly of Aluminum Structural Plate Single Radius Arch

Installation Recommendations

Required Elements

Satisfactory site preparation, trench excavation, bedding and backfill operations are essential to develop the strength of any flexible conduit. In order to obtain proper strength while preventing settlement, it is necessary that the soil envelope around the structure be of good granular material, properly placed, and carefully compacted.

Pipe-arch and underpass shapes pose special installation concerns. These shapes generate high corner bearing pressures against the side fill and foundation, see page 55 and 59 for the allowable corner bearing capacity. Therefore, special installation care must be implemented to achieve a composite soil structure.

A qualified Engineer should be engaged to design a proper foundation, adequate bedding, and backfill.

Trench Excavation

If the adjacent embankment material is structurally adequate, the trench requires only a bottom clear width of the structure's span plus sufficient room for compaction equipment.

Bedding

Proper bedding preparation is critical to both structure performance and service life. The bedding should be constructed to a uniform line and grade to avoid distortions that may create undesirable stresses in the structure and/or rapid deterioration of the roadway. It should be free of rock formations, protruding stones, and frozen matter that may cause unequal settlement.

It is recommended that the bedding be a relatively loose granular material that is roughly shaped to fit the bottom of the structure, be a minimum of twice the corrugation depth in thickness and have a maximum particle size of one half the corrugation depth.

It should be noted that the bedding depth can vary based on the amount of cover and the shape of the structure's invert. The bedding should be shaped to match structures with flatter inverts.

Please reference the project specifications, drawing submittals and Contech's Assembly and Installation Guide for more information.

Assembly

Assembly drawings and detailed assembly instructions are shipped with each order. Structures can be preassembled and lifted into place all at once or in sections, allowing for staged construction. If the site conditions allow, structures can be assembled in place. A qualified engineer should be engaged to determine the most appropriate assembly method based on the site conditions. For additional information contact your local Contech representative.

Backfill

Satisfactory backfill material, proper placement and compaction are key factors in obtaining maximum strength and stability. Compaction needs to be achieved under the haunches by carefully tamping a granular or select material.

The backfill material should be free of rocks, frozen lumps and foreign material that could cause hard spots or decompose to create voids. Backfill material should be well graded granular material that meets the requirements of AASHTO M 145 for soil classifications A-1, A-2-4, A-2-5, or A-3. Backfill must be placed symmetrically on each side of the structure in 8-inch uncompacted lifts, with no side-to-side differential exceeding 24-inches. Each lift is to be compacted to a minimum 90% density per AASHTO T-180.

A high percentage of silt or fine sand in the native soils suggests the need for a well graded granular backfill material to prevent soil migration.

During backfill, only small tracked vehicles (20,000 lbs. or smaller) should be near the structure as fill progresses above the crown and to the finished grade. The engineer and contractor are cautioned that the minimum cover may need to be increased to handle temporary construction vehicle loads (heavier than the design highway load).

Precautions

During installation and prior to the construction of permanent erosion control and end treatment protection, special precautions may be necessary.

The structure must be protected from unbalanced loading or conditions or hydraulic forces that might bend or distort the unsupported ends of the structure.

Erosion or washout of previously placed soil support must be prevented to ensure that the structure maintains its load capacity.

Salt Water Installation

In salt water installations, the bedding and backfill around the structure must be clean, free draining, granular material. You should consider using aluminum fasteners for these type of applications. If the backfill is subject to possible infiltration by the adjacent native soil, the clean granular backfill should be wrapped in a geotextile.

Aluminum Box Culverts

The Solution for Small Bridge Replacement: Aluminum Box Culverts

Contech Aluminum Box Culverts are a practical and cost-efficient solution for small bridge replacement. They have an overall lower installed cost due to material efficiencies when compared with cast-in-place concrete structures. There are no forms to set and remove, no delays due to curing time, large installation crews are unnecessary and no special equipment is typically needed. Cranes may occasionally be required to lift fully assembled structures.

These wide-span, low-rise structures are available in a large range of standard sizes (from 8'-9" span x 2'-6" rise to 35'-3" span x 13'-7" rise) that permit a minimum cover beginning as low as 1'-5". Information is provided in the following tables for HL-93, HS-20 and HS-25 live loading, since these loads are still widely considered in design.

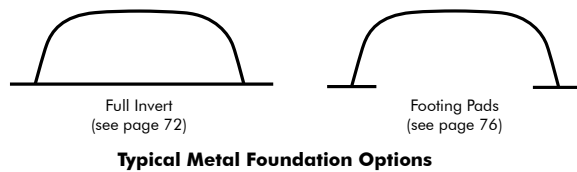

Efficient Installations for Lower Installed Costs

Closing roads for bridge replacement causes extensive traffic detours, so minimizing installation time is critical. Depending on length of structure, Aluminum Box Culverts may be erected in place and are immediately ready to be backfilled. To aid in accelerated bridge construction, Aluminum Box Culverts can be completely assembled nearby while the foundation is being prepared. Light equipment can then be used to pick and set them in place. For more information, contact your local Contech representative.



Lifting of Aluminum Box Culvert



Installation of Ribs



Corrugated Aluminum Box Culvert with Headwall Package

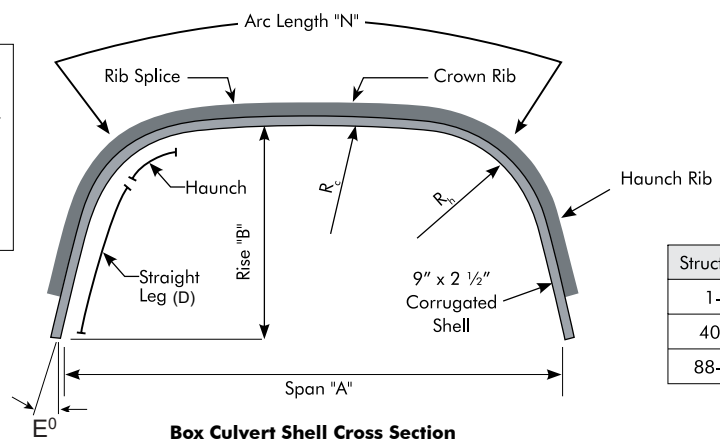
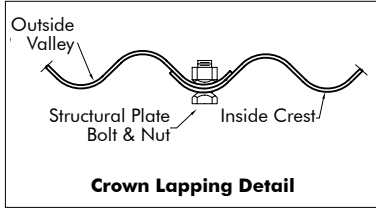

Structure #	R_c	R_h
1-39	297.50"	30.250"
40-87	258.75"	37.380"
88-143	310.75"	43.625"

Box Culvert Shell Cross Section

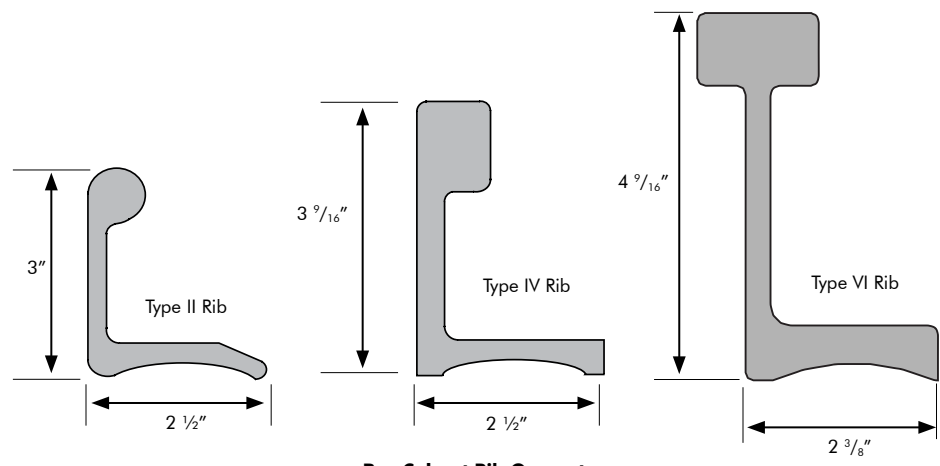

Box Culvert Rib Geometry

Notes:

- Structure 1 is a one-plate shell. Structures 2-26 are two plate shells. Structures 27-143 are three-plate shells.
- In Shell Fill Height Tables 48A, 48B, 49A and 49B, the numerical designation for HG/CG indicates thickness or gage of haunch (HG) and crown (CG) plates as follows:
 2=.125"
 3=.150"
 4=.175"
 5=.200"
 6=.225"
 7=.250"
 Example: The HG/CG for 3/6=.150" haunch and .225" crown plate thickness. The HRS/CRS designation indicates the rib spacing on the haunch (HRS) and crown (CRS) plates. Example: 27/9=27" o.c. haunch rib spacing and 9" o.c. crown rib spacing.
- Allowable cover (minimum and maximum) is measured from the outside valley (inside rise location) of the crown plate to bottom of the flexible pavement or to the top of rigid pavement. Minimum cover is measured at the lowest fill area subjected to possible wheel loads (typically at the roadway shoulder). The roadway surface must be maintained to ensure minimum cover to prevent high-impact loads being imparted to the structure. Maximum cover is measured at the highest fill and/or pavement elevation. Please reference AASHTO 12.9.4.2.
- Select the structure with the lowest alphabetical sub-designation and cover range that will include the actual minimum and maximum cover.
 Example: Structure 51-A6 is more economical than 51-B6 if the cover is between 3.0 and 4.5 feet.
- Shell weight per foot (Wt./Ft.) of shell includes plates, reinforcing ribs, rib splices, bolts, and nuts.
- Total structure length can be any dimension, but whenever possible, it is recommended to work with a multiple of 4.5' (net plate length). This practice usually results in lower total structure cost. Example: 50' proposed structure $\div 4.5' = 11.1$, nearest whole number is 11, therefore use $11 \times 4.5' = 49.5'$ for total structure length. When ordering a structure with headwalls on each end, total structure length must be a multiple of 9 inches (see page 48 plate detail).
- Shell data in Table 48A is designed for standard highway live load HS-20, Table 48B for HS-25 and Tables 49A/49B for HL-93. Contact your local Contech representative for design information on other loadings.
- For custom live loads, special rib combinations and spacing are available.
- The maximum cover for Aluminum Box Culverts with full inverts and footing pads should not exceed 4 feet with a minimum 4,000 psf allowable soil-bearing capacity. Special full invert and footing pad designs or slotted concrete footings can accommodate maximum covers to the limits shown in Tables 48A, 48B, 49A, and 49B.

Box Culvert Shell-Plate and Rib Data (HL-93)

TABLE 49A. SHELL DATA – HL-93 LOADING
PLATE AND RIB COMBINATIONS WITH ALLOWABLE HEIGHT OF COVER

Structure	Span "A"	Rise "B"	Area	R1						R2						R3					
				HG/CG	HRS/CRS	HR/CR	Min.	Max.	Shell	HG/CG	HRS/CRS	HR/CR	Min.	Max.	Shell	HG/CG	HRS/CRS	HR/CR	Min.	Max.	Shell
				(Gage)	(Inches)	(Type)	(Feet)	(Lbs.)	(Gage)	(Inches)	(Type)	(Feet)	(Lbs.)	(Gage)	(Inches)	(Type)	(Feet)	(Lbs.)			
Number	Ft.-In.	Ft.-In.	Sq. Ft.	(Gage)	(Inches)	(Type)	(Feet)	(Lbs.)	(Gage)	(Inches)	(Type)	(Feet)	(Lbs.)	(Gage)	(Inches)	(Type)	(Feet)	(Lbs.)			
1	8-9	2-6	18.4	3/3	54/18	II/IV	1.4	5.0	50												
2	9-2	3-3	25.4	2/2	54/18	II/IV	1.4	5.0	54												
3	9-7	4-1	32.6	2/2	54/18	II/IV	1.5	5.0	57	2/2	54/18	IV/IV	1.4	5.0	59						
4	10-0	4-10	40.2	2/2	54/18	II/IV	1.7	5.0	61	2/2	54/18	IV/IV	1.4	5.0	63						
5	10-6	5-7	48.1	2/2	54/18	II/IV	2.1	5.0	65	3/3	54/18	IV/IV	1.4	5.0	75						
6	10-11	6-4	56.4	2/2	54/18	II/IV	2.3	5.0	69	3/3	54/18	IV/IV	1.4	5.0	79						
7	11-4	7-2	65.0	2/2	54/18	II/IV	2.6	5.0	73	2/2	54/18	IV/VI	1.4	5.0	79						
8	10-2	2-8	23.0	2/2	54/18	II/IV	1.9	5.0	57	2/2	54/18	IV/VI	1.4	5.0	63						
9	10-7	3-5	31.1	2/2	54/18	II/IV	2.1	5.0	61	2/2	54/18	IV/VI	1.4	5.0	68						
10	10-11	4-3	39.5	2/2	54/18	II/IV	2.3	5.0	66	2/2	54/18	IV/VI	1.4	5.0	73						
11	11-4	5-0	48.2	2/2	54/18	II/IV	2.6	5.0	70	2/2	54/18	IV/VI	1.4	5.0	77						
12	11-8	5-9	57.2	2/2	54/18	II/IV	2.8	5.0	74	2/2	54/18	IV/VI	1.4	5.0	81						
13	12-1	6-7	66.4	2/2	54/18	II/IV	3.1	5.0	78	2/2	54/18	IV/VI	1.4	5.0	85						
14	12-5	7-4	76.0	2/2	54/18	II/IV	3.4	5.0	81	2/2	54/18	IV/VI	1.4	5.0	88						
15	11-7	2-10	28.1	2/2	54/18	II/IV	2.7	5.0	64	2/2	54/18	IV/VI	1.4	5.0	72						
16	11-11	3-7	37.4	2/2	54/18	II/IV	2.9	5.0	69	2/2	54/18	IV/VI	1.4	5.0	78						
17	12-3	4-5	46.9	2/2	54/18	II/IV	3.2	5.0	73	2/2	54/18	IV/VI	1.4	5.0	82						
18	12-7	5-2	56.6	2/2	54/18	II/IV	4.1	5.0	77	2/2	54/18	IV/VI	1.4	5.0	86						
19	12-11	6-0	66.6	3/3	54/18	II/IV	2.9	5.0	90	2/2	54/18	IV/VI	1.4	5.0	91						
20	13-3	6-9	76.9	3/3	54/18	II/IV	3.2	5.0	95	3/3	54/18	IV/VI	1.4	5.0	104						
21	13-0	3-0	33.8	3/3	54/18	IV/IV	2.6	5.0	80	2/2	54/18	IV/VI	1.4	5.0	82						
22	13-4	3-10	44.2	3/3	54/18	IV/IV	2.8	5.0	86	3/3	54/18	IV/VI	1.4	5.0	95						
23	13-7	4-7	54.8	3/3	54/18	IV/IV	2.9	5.0	91	3/3	54/18	IV/VI	1.4	5.0	100						
24	13-10	5-5	65.6	3/3	54/18	IV/IV	3.1	5.0	95	2/2	27/18	IV/VI	1.4	5.0	107						
25	14-1	6-2	76.6	3/3	54/18	IV/IV	3.4	5.0	101	2/2	27/18	IV/VI	1.4	5.0	111						
26	14-5	3-3	40.0	2/2	54/18	IV/VI	2.8	5.0	90	2/2	18/18	IV/VI	1.4	5.0	105						
27	14-8	4-1	51.5	3/2	54/18	IV/VI	2.0	5.0	101	2/2	18/18	IV/VI	1.4	5.0	113						
28	14-10	4-10	63.2	3/2	54/18	IV/VI	2.1	5.0	108	2/2	18/18	IV/VI	1.4	5.0	121						
29	15-1	5-8	75.1	3/2	54/18	IV/VI	2.3	5.0	112	3/3	18/18	IV/VI	1.4	5.0	134						
30	15-4	6-5	87.2	3/3	54/18	IV/VI	2.5	5.0	119	3/3	18/18	IV/VI	1.4	5.0	138						
31	15-6	7-3	99.4	3/3	54/18	IV/VI	2.6	5.0	123	3/3	18/18	IV/VI	1.4	5.0	143						
32	15-9	8-0	111.8	3/3	54/18	IV/VI	2.9	5.0	128	2/2	18/9	IV/VI	1.4	5.0	172						
33	15-10	3-6	46.8	2/2	27/18	IV/VI	2.3	5.0	110	2/2	18/9	IV/VI	1.4	5.0	156						
34	16-0	4-3	59.5	2/2	27/18	IV/VI	2.4	5.0	116	2/2	18/9	IV/VI	1.4	5.0	163						
35	16-2	5-1	72.3	2/2	27/18	IV/VI	2.4	5.0	122	2/2	18/9	IV/VI	1.4	5.0	171						
36	16-4	5-11	85.2	2/2	27/18	IV/VI	2.5	5.0	126	2/2	18/9	IV/VI	1.4	5.0	175						
37	16-6	6-8	98.3	2/2	27/18	IV/VI	2.6	5.0	129	2/2	18/9	IV/VI	1.4	5.0	178						
38	16-8	7-6	111.5	2/2	27/18	IV/VI	2.7	5.0	134	2/2	18/9	IV/VI	1.4	5.0	182						
39	16-10	8-3	124.8	2/2	27/18	IV/VI	2.7	5.0	137	2/2	18/9	IV/VI	1.4	5.0	186						
40	17-9	3-10	54.4	2/2	54/18	VI/VI	3.2	5.0	113	2/2	27/18	VI/VI	2.2	5.0	127	2/2	27/9	VI/VI	1.4	5.0	171
41	18-2	4-7	68.3	3/2	54/18	VI/VI	3.3	5.0	125	2/2	27/18	VI/VI	2.4	5.0	133	2/2	27/9	VI/VI	1.4	5.0	178
42	18-7	5-4	82.5	2/2	27/18	VI/VI	2.6	5.0	141	2/2	18/18	VI/VI	1.9	5.0	154	2/2	18/9	VI/VI	1.4	5.0	200
43	19-0	6-1	97.1	2/2	27/18	VI/VI	2.8	5.0	148	2/2	18/18	VI/VI	2.0	5.0	163	2/2	18/9	VI/VI	1.4	5.0	209
44	19-5	6-11	111.9	2/2	27/18	VI/VI	3.0	5.0	152	2/2	18/18	VI/VI	2.1	5.0	167	2/2	18/9	VI/VI	1.4	5.0	213
45	19-10	7-8	127.1	2/2	27/18	VI/VI	3.5	4.5	156	2/2	18/18	VI/VI	2.2	5.0	171	2/2	18/9	VI/VI	1.4	5.0	217
46	20-3	8-5	142.6	3/3	27/18	VI/VI	3.5	3.9	173	2/2	18/18	VI/VI	2.4	5.0	175	2/2	18/9	VI/VI	1.4	5.0	221
47	19-1	4-2	63.3	2/2	27/18	VI/VI	2.9	5.0	135	2/2	18/18	VI/VI	2.0	5.0	145	2/2	18/9	VI/VI	1.4	5.0	196
48	19-5	4-11	78.3	2/2	27/18	VI/VI	3.0	5.0	143	2/2	18/18	VI/VI	2.1	5.0	154	2/2	18/9	VI/VI	1.4	5.0	206
49	19-9	5-8	93.6	2/2	27/18	VI/VI	3.4	4.8	150	2/2	18/18	VI/VI	2.2	5.0	163	2/2	18/9	VI/VI	1.4	5.0	215
50	20-1	6-6	109.2	3/2	27/18	VI/VI	3.5	3.9	165	2/2	18/18	VI/VI	2.3	5.0	173	2/2	18/9	VI/VI	1.4	5.0	224
51	20-6	7-3	125.0	2/2	18/18	VI/VI	2.5	5.0	176	4/5	18/18	VI/VI	2.2	5.0	206	2/2	18/9	VI/VI	1.4	5.0	227
52	20-10	8-1	141.2	2/2	18/18	VI/VI	2.6	5.0	180	4/5	18/18	VI/VI	2.3	5.0	211	2/2	18/9	VI/VI	1.4	5.0	231
53	21-2	8-10	157.6	2/2	18/18	VI/VI	2.7	5.0	185	5/4	18/18	VI/VI	2.4	5.0	223	2/2	18/9	VI/VI	1.4	5.0	235
54	20-4	4-6	73.1	2/2	18/18	VI/VI	2.4	5.0	154	5/4	18/18	VI/VI	2.2	5.0	181	2/2	18/9	VI/VI	1.4	5.0	212
55	20-7	5-3	89.2	2/2	18/18	VI/VI	2.5	5.0	163	5/5	18/18	VI/VI	2.2	5.0	198	2/2	18/9	VI/VI	1.4	5.0	220
56	20-11	6-1	105.5	2/2	18/18	VI/VI	2.6	5.0	173	5/5	18/18	VI/VI	2.3	5.0	209	2/2	18/9	VI/VI	1.4	5.0	229
57	21-3	6-10	122.1	2/2	18/18	VI/VI	2.7	5.0	181	5/5	18/18	VI/VI	2.4	5.0	220	2/2	18/9	VI/VI	1.4	5.0	239
58	21-6	7-8	139.0	2/2	18/18	VI/VI	2.8	5.0	185	2/2	18/9	VI/VI	1.5	5.0	243	3/3	18/9	VI/VI	1.4	5.0	256
59	21-10	8-5	156.0	2/2	18/18	VI/VI	3.0	5.0	189	2/2	18/9	VI/VI	1.6	5.0	247	3/3	18/9	VI/VI	1.4	5.0	260
60	22-1	9-3	173.3	2/2	18/18	VI/VI	3.1	4.8	193	2/2	18/9	VI/VI	1.7	5.0	251	3/3	18/9	VI/VI	1.4	5.0	266
61	21-7	4-11	83.8	2/2	18/18	VI/VI	2.9	5.0	163	2/2	18/9	VI/VI	1.5	5.0	225	3/3	18/9	VI/VI	1.4	5.0	236
62	21-10	5-8	101.0	2/2	18/18	VI/VI	3.0	5.0	173	2/2	18/9	VI/VI	1.6	5.0	236	3/3	18/9	VI/VI	1.4	5.0	248
63	22-1	6-6	118.4	2/2	18/18	VI/VI	3.1	4.8	181	2/2	18/9	VI/VI	1.7	5.0	244	3/3	18/9	VI/VI	1.4	5.0	257
64	22-3	7-3	135.9	2/2	18/18	VI/VI	3.2	4.4	191	2/2	18/9	VI/VI	1.7	5.0	253	4/4	18/9	VI/VI	1.4	5.0	280
65	22-6	8-1	153.7	3/2	18/18	VI/VI	3.2	4.2	204	2/2	18/9	VI/VI	1.8	5.0	258	4/4	18/9	VI/VI	1.4	5.0	286
66	22-9	8-10	171.6	2/3	9/18	VI/VI	2.8	5.0	259	2/2	18/9	VI/VI	1.8	5.0	261	4/4	18/9	VI/VI	1.4	5.0	291
67	23-0	9-8	189.8	2/3	9/18	VI/VI	2.9	5.0	263	2/2	18/9	VI/VI	1.9	5.0	265	4/4	18/9	VI/VI	1.4	5.0	296
68	22-9	5-4	95.5	2/3	9/18	VI/VI	2.8	5.0	217	2/2	18/9	VI/VI	1.8	5.0	240	4/4	18/9	VI/VI	1.4	5.0	264
69	23-0	6-1	113.7	2/3	9/18	VI/VI	2.9	5.0	241	2/2	18/9	VI/VI	1.9	5.0	244	4/4	18/9	VI/VI	1.4	5.0	275
70	23-2	6-11	132.1	2/3	9/18	VI/VI	2.9	5.													

Box Culvert Shell-Plate and Rib Data (HL-93)

TABLE 48B. SHELL DATA – HL-93 LOADING
PLATE AND RIB COMBINATIONS WITH ALLOWABLE HEIGHT OF COVER

Structure Number	Span "A" Ft.-In.	Rise "B" Ft.-In.	Area Sq. Ft.	R1						R2						R3					
				HG/CG	HRS/CRS	HR/CR	Min.	Max.	Shell Wt./Ft.	HG/CG	HRS/CRS	HR/CR	Min.	Max.	Shell Wt./Ft.	HG/CG	HRS/CRS	HR/CR	Min.	Max.	Shell Wt./Ft.
				(Gage)	(Inches)	(Type)	(Feet)	(Feet)	(Lbs.)	(Gage)	(Inches)	(Type)	(Feet)	(Feet)	(Lbs.)	(Gage)	(Inches)	(Type)	(Feet)	(Feet)	(Lbs.)
88	26-7	5-5	111.6	3/3	9/18	VI/VI	4.0	5.0	246	3/3	9/9	VI/VI	2.3	5.0	314	3/4	9/9	VI/VI	2.0	5.0	320
89	27-0	6-3	132.4	3/3	9/18	VI/VI	4.0	5.0	261	3/3	9/9	VI/VI	2.3	5.0	329	3/4	9/9	VI/VI	2.0	5.0	335
90	27-5	7-0	153.4	3/3	9/18	VI/VI	4.0	5.0	276	3/3	9/9	VI/VI	2.3	5.0	344	3/4	9/9	VI/VI	2.0	5.0	350
91	27-10	7-9	174.8	3/3	9/18	VI/VI	4.0	5.0	292	3/3	9/9	VI/VI	2.3	5.0	360	3/4	9/9	VI/VI	2.0	5.0	366
92	28-3	8-7	196.5	3/3	9/18	VI/VI	4.0	5.0	296	3/3	9/9	VI/VI	2.3	5.0	364	3/4	9/9	VI/VI	2.0	5.0	370
93	28-8	9-4	218.6	3/3	9/18	VI/VI	4.0	5.0	300	3/3	9/9	VI/VI	2.3	5.0	368	3/4	9/9	VI/VI	2.0	5.0	374
94	29-2	10-1	241.0	3/3	9/18	VI/VI	4.0	5.0	304	3/3	9/9	VI/VI	2.3	5.0	372	3/5	9/9	VI/VI	2.0	5.0	383
95	27-10	5-10	125.4	3/3	9/18	VI/VI	4.0	5.0	261	3/3	9/9	VI/VI	2.3	5.0	329	3/4	9/9	VI/VI	2.0	5.0	335
96	28-3	6-8	147.3	3/3	9/18	VI/VI	4.0	5.0	276	3/3	9/9	VI/VI	2.3	5.0	344	3/4	9/9	VI/VI	2.0	5.0	350
97	28-7	7-5	169.4	3/3	9/18	VI/VI	4.0	5.0	292	3/3	9/9	VI/VI	2.3	5.0	360	3/4	9/9	VI/VI	2.0	5.0	366
98	29-0	8-3	191.8	3/3	9/18	VI/VI	4.0	5.0	307	3/3	9/9	VI/VI	2.3	5.0	375	3/5	9/9	VI/VI	2.0	5.0	386
99	29-4	9-0	214.6	3/3	9/18	VI/VI	4.0	5.0	311	3/3	9/9	VI/VI	2.3	5.0	379	3/5	9/9	VI/VI	2.0	5.0	390
100	29-8	9-9	237.6	3/3	9/18	VI/VI	4.0	5.0	315	3/3	9/9	VI/VI	2.3	5.0	383	3/5	9/9	VI/VI	2.0	5.0	394
101	30-1	10-7	260.9	3/3	9/18	VI/VI	4.0	5.0	319	3/3	9/9	VI/VI	2.4	5.0	387	3/5	9/9	VI/VI	2.0	5.0	398
102	29-1	6-4	140.2	3/3	9/18	VI/VI	4.0	5.0	276	3/3	9/9	VI/VI	2.3	5.0	344	3/5	9/9	VI/VI	2.0	5.0	357
103	29-5	7-1	163.2	3/3	9/18	VI/VI	4.0	5.0	292	3/3	9/9	VI/VI	2.3	5.0	360	3/5	9/9	VI/VI	2.0	5.0	373
104	29-8	7-11	186.4	3/3	9/18	VI/VI	4.0	5.0	307	3/3	9/9	VI/VI	2.3	5.0	375	3/5	9/9	VI/VI	2.0	5.0	388
105	30-0	8-8	209.8	3/3	9/18	VI/VI	4.0	5.0	322	3/3	9/9	VI/VI	2.4	5.0	390	3/5	9/9	VI/VI	2.0	5.0	403
106	30-4	9-5	233.6	3/3	9/18	VI/VI	4.0	5.0	326	3/3	9/9	VI/VI	2.4	5.0	394	3/5	9/9	VI/VI	2.0	5.0	407
107	30-8	10-3	257.5	3/3	9/18	VI/VI	4.0	5.0	330	3/3	9/9	VI/VI	2.4	5.0	398	3/5	9/9	VI/VI	2.0	5.0	411
108	31-0	11-0	281.8	3/3	9/18	VI/VI	4.0	5.0	335	3/3	9/9	VI/VI	2.4	5.0	403	3/5	9/9	VI/VI	2.0	5.0	416
109	30-3	6-9	156.1	3/3	9/18	VI/VI	4.0	5.0	287	3/3	9/9	VI/VI	2.5	5.0	360	3/5	9/9	VI/VI	2.0	5.0	373
110	30-6	7-7	180.1	3/3	9/18	VI/VI	4.0	5.0	302	3/3	9/9	VI/VI	2.4	5.0	375	3/5	9/9	VI/VI	2.0	5.0	388
111	30-10	8-4	204.4	3/3	9/18	VI/VI	4.0	5.0	317	3/3	9/9	VI/VI	2.4	5.0	390	3/5	9/9	VI/VI	2.0	5.0	403
112	31-1	9-2	228.8	3/3	9/18	VI/VI	4.0	5.0	332	3/3	9/9	VI/VI	2.4	5.0	405	3/5	9/9	VI/VI	2.0	5.0	418
113	31-4	9-11	253.5	4/3	9/18	VI/VI	4.0	5.0	346	3/3	9/9	VI/VI	2.5	5.0	409	3/5	9/9	VI/VI	2.0	5.0	422
114	31-8	10-9	278.4	4/3	9/18	VI/VI	4.0	5.0	351	3/3	9/9	VI/VI	2.5	5.0	414	3/5	9/9	VI/VI	2.0	5.0	427
115	31-11	11-6	303.5	4/3	9/18	VI/VI	4.0	5.0	356	3/3	9/9	VI/VI	2.5	5.0	418	3/5	9/9	VI/VI	2.0	5.0	431
116	31-5	7-3	173.1	4/3	9/18	VI/VI	4.0	5.0	304	3/3	9/9	VI/VI	2.5	5.0	375	3/5	9/9	VI/VI	2.0	5.0	388
117	31-8	8-0	198.2	4/3	9/18	VI/VI	4.0	5.0	320	3/3	9/9	VI/VI	2.5	5.0	390	3/5	9/9	VI/VI	2.0	5.0	403
118	31-10	8-10	223.4	4/3	9/18	VI/VI	4.0	5.0	336	3/3	9/9	VI/VI	2.5	5.0	405	3/5	9/9	VI/VI	2.0	5.0	418
119	32-1	9-8	248.8	4/3	9/18	VI/VI	4.0	5.0	352	3/3	9/9	VI/VI	2.5	5.0	420	3/5	9/9	VI/VI	2.0	5.0	433
120	32-3	10-5	274.4	4/3	9/18	VI/VI	4.0	5.0	357	3/3	9/9	VI/VI	2.5	5.0	424	3/5	9/9	VI/VI	2.0	5.0	437
121	32-7	11-3	300.1	4/3	9/18	VI/VI	4.0	5.0	362	3/3	9/9	VI/VI	2.5	5.0	429	3/5	9/9	VI/VI	2.0	5.0	442
122	32-8	12-0	326.1	4/3	9/18	VI/VI	4.0	5.0	367	3/3	9/9	VI/VI	2.5	5.0	433	3/5	9/9	VI/VI	2.0	5.0	446
123	32-7	7-9	191.3	4/3	9/18	VI/VI	4.0	5.0	314	3/3	9/9	VI/VI	2.5	5.0	390	3/5	9/9	VI/VI	2.0	5.0	403
124	32-9	8-6	217.3	4/3	9/18	VI/VI	4.0	5.0	330	3/3	9/9	VI/VI	2.5	5.0	405	3/5	9/9	VI/VI	2.0	5.0	418
125	32-11	9-4	243.4	4/3	9/18	VI/VI	4.0	5.0	346	3/3	9/9	VI/VI	2.5	5.0	420	3/5	9/9	VI/VI	2.0	5.0	433
126	33-1	10-2	269.7	4/3	9/18	VI/VI	4.0	5.0	362	3/3	9/9	VI/VI	2.5	5.0	435	3/5	9/9	VI/VI	2.0	5.0	448
127	33-3	10-11	296.4	4/3	9/18	VI/VI	4.0	5.0	367	3/3	9/9	VI/VI	2.5	5.0	440	3/6	9/9	VI/VI	2.0	5.0	454
128	33-5	11-9	322.8	4/3	9/18	VI/VI	4.0	5.0	372	3/3	9/9	VI/VI	2.5	5.0	444	3/6	9/9	VI/VI	2.0	5.0	466
129	33-8	12-6	349.5	4/3	9/18	VI/VI	4.0	5.0	376	3/3	9/9	VI/VI	2.5	5.0	448	3/6	9/9	VI/VI	2.0	5.0	470
130	33-8	8-3	210.5	4/3	9/18	VI/VI	4.0	5.0	325	3/3	9/9	VI/VI	2.5	5.0	405	3/6	9/9	VI/VI	2.0	5.0	427
131	33-9	9-1	237.5	4/3	9/18	VI/VI	4.0	5.0	340	3/3	9/9	VI/VI	2.5	5.0	420	3/6	9/9	VI/VI	2.0	5.0	442
132	33-11	9-10	264.5	4/3	9/18	VI/VI	4.0	5.0	356	3/3	9/9	VI/VI	2.5	5.0	435	3/6	9/9	VI/VI	2.0	5.0	457
133	34-0	10-8	291.7	4/3	9/18	VI/VI	4.0	5.0	372	3/3	9/9	VI/VI	2.5	5.0	451	3/6	9/9	VI/VI	2.0	5.0	473
134	34-2	11-5	319.0	4/3	9/18	VI/VI	4.0	5.0	377	3/3	9/9	VI/VI	2.5	5.0	455	3/6	9/9	VI/VI	2.0	5.0	477
135	34-3	12-3	346.4	4/3	9/18	VI/VI	4.0	5.0	382	3/3	9/9	VI/VI	2.5	5.0	459	3/6	9/9	VI/VI	2.0	5.0	481
136	34-5	13-1	373.8	4/3	9/18	VI/VI	4.0	5.0	387	3/3	9/9	VI/VI	2.5	5.0	463	3/6	9/9	VI/VI	2.0	5.0	485
137	34-9	8-9	230.9	4/3	9/18	VI/VI	4.0	5.0	335	3/3	9/9	VI/VI	2.5	5.0	420	3/6	9/9	VI/VI	2.0	5.0	442
138	34-10	9-7	258.1	4/3	9/18	VI/VI	4.0	5.0	351	3/3	9/9	VI/VI	2.5	5.0	435	3/6	9/9	VI/VI	2.0	5.0	457
139	34-11	10-4	286.7	4/3	9/18	VI/VI	4.0	5.0	367	3/3	9/9	VI/VI	2.5	5.0	451	3/6	9/9	VI/VI	2.0	5.0	473
140	35-0	11-2	314.6	4/3	9/18	VI/VI	4.0	5.0	382	3/3	9/9	VI/VI	2.5	5.0	466	3/6	9/9	VI/VI	2.0	5.0	488
141	35-1	12-0	342.7	4/3	9/18	VI/VI	4.0	5.0	387	3/3	9/9	VI/VI	2.5	5.0	470	3/6	9/9	VI/VI	2.0	5.0	492
142	35-2	12-9	370.8	4/3	9/18	VI/VI	4.0	5.0	392	3/3	9/9	VI/VI	2.5	5.0	474	3/6	9/9	VI/VI	2.0	5.0	496
143	35-3	13-7	399.0	4/3	9/18	VI/VI	4.0	5.0	394	3/3	9/9	VI/VI	2.5	5.0	476	3/6	9/9	VI/VI	2.0	5.0	500

See Notes page 63



Fully Assembled Aluminum Box Culvert Being Set in Place

Aluminum Box Culvert

Box Culvert Shell-Plate and Rib Data (H-20, HS-20)

**TABLE 49A. SHELL DATA – H-20, HS-20 LOADING
PLATE AND RIB COMBINATIONS WITH ALLOWABLE HEIGHT OF COVER**

Structure Number	Span "A" Ft.-In.	Rise "B" Ft.-In.	Area Sq. Ft.	A6						B6					
				HG/CG	HRS/CRS	HR/CR	Min.	Max.	Shell Wt./Ft.	HG/CG	HRS/CRS	HR/CR	Min.	Max.	Shell Wt./Ft.
				(Gage)	(Inches)	(Type)	(Feet)		(Lbs.)	(Gage)	(Inches)	(Type)	(Feet)		(Lbs.)
1	8-9	2-6	18.4	3/3	54/18	II/IV	1.4	5.0	50						
2	9-2	3-3	25.4	2/2	54/18	II/IV	1.4	5.0	54						
3	9-7	4-1	32.6	2/2	54/18	II/IV	1.4	5.0	57						
4	10-0	4-10	40.2	2/2	54/18	II/IV	1.4	5.0	61						
5	10-6	5-7	48.1	2/2	54/18	II/IV	1.7	5.0	65	3/3	54/18	II/IV	1.4	5.0	73
6	10-11	6-4	56.4	2/2	54/18	II/IV	1.9	5.0	69	2/2	27/18	II/IV	1.4	5.0	77
7	11-4	7-2	65.0	2/2	54/18	II/IV	2.1	5.0	73	2/2	54/9	II/IV	1.4	5.0	83
8	10-2	2-8	23.0	2/2	54/18	II/IV	1.5	5.0	57	3/3	54/18	II/IV	1.4	5.0	62
9	10-7	3-5	31.1	2/2	54/18	II/IV	1.7	5.0	61	3/3	54/18	II/IV	1.4	5.0	67
10	10-11	4-3	39.5	2/2	54/18	II/IV	1.9	5.0	66	3/3	54/18	II/IV	1.4	5.0	73
11	11-4	5-0	48.2	2/2	54/18	II/IV	2.1	5.0	70	3/3	54/18	II/IV	1.4	5.0	78
12	11-8	5-9	57.2	2/2	54/18	II/IV	2.3	5.0	74	2/2	54/18	IV/VI	1.4	5.0	81
13	12-1	6-7	66.4	2/2	54/18	II/IV	2.5	5.0	78	2/2	54/18	IV/VI	1.4	5.0	85
14	12-5	7-4	76.0	2/2	54/18	II/IV	2.7	5.0	81	2/2	54/18	IV/VI	1.4	5.0	88
15	11-7	2-10	28.1	2/2	54/18	II/IV	2.3	5.0	65	2/2	54/18	IV/VI	1.4	5.0	72
16	11-11	3-7	37.4	2/2	54/18	II/IV	2.5	5.0	71	2/2	54/18	IV/VI	1.4	5.0	78
17	12-3	4-5	46.9	2/2	54/18	II/IV	2.6	5.0	75	2/2	54/18	IV/VI	1.4	5.0	82
18	12-7	5-2	56.6	2/2	54/18	II/IV	2.8	5.0	79	2/2	54/18	IV/VI	1.4	5.0	86
19	12-11	6-0	66.6	2/2	54/18	II/IV	3.0	5.0	84	2/2	54/18	IV/VI	1.4	5.0	91
20	13-3	6-9	76.9	3/3	54/18	II/IV	2.5	5.0	95	2/2	54/18	IV/VI	1.4	5.0	94
21	13-0	3-0	33.8	3/3	54/18	II/IV	2.4	5.0	79	2/2	54/18	IV/VI	1.4	5.0	82
22	13-4	3-10	44.2	3/3	54/18	II/IV	2.5	5.0	84	2/2	54/18	IV/VI	1.4	5.0	87
23	13-7	4-7	54.8	3/3	54/18	II/IV	2.7	5.0	89	2/2	54/18	IV/VI	1.4	5.0	92
24	13-10	5-5	65.6	2/2	27/18	II/IV	3.0	5.0	95	2/2	54/18	IV/VI	1.4	5.0	96
25	14-1	6-2	76.6	3/3	54/18	II/IV	3.0	5.0	99	2/2	54/18	IV/VI	1.4	5.0	100
26	14-5	3-3	40.0	2/2	54/18	IV/VI	1.4	5.0	90						
27	14-8	4-1	51.5	2/2	54/18	IV/VI	1.6	5.0	96	3/2	54/18	IV/VI	1.4	5.0	101
28	14-10	4-10	63.2	2/2	54/18	IV/VI	1.7	5.0	102	3/2	54/18	IV/VI	1.4	5.0	108
29	15-1	5-8	75.1	2/2	54/18	IV/VI	2.1	5.0	105	3/2	54/18	IV/VI	1.4	5.0	112
30	15-4	6-5	87.2	2/2	54/18	IV/VI	2.3	5.0	109	3/2	54/18	IV/VI	1.4	5.0	116
31	15-6	7-3	99.4	2/2	54/18	IV/VI	2.5	4.7	112	3/3	54/18	IV/VI	1.4	5.0	123
32	15-9	8-0	111.8	2/2	54/18	IV/VI	2.8	3.8	116	2/2	27/18	IV/VI	1.4	5.0	128
33	15-10	3-6	46.8	2/2	54/18	IV/VI	2.9	3.7	101	2/2	27/18	IV/VI	1.4	5.0	110
34	16-0	4-3	59.5	3/2	54/18	IV/VI	1.7	5.0	112	2/2	27/18	IV/VI	1.4	5.0	116
35	16-2	5-1	72.3	3/2	54/18	IV/VI	1.8	5.0	117	2/2	27/18	IV/VI	1.4	5.0	122
36	16-4	5-11	85.2	3/2	54/18	IV/VI	1.9	5.0	122	3/2	27/18	IV/VI	1.4	5.0	133
37	16-6	6-8	98.3	3/3	54/18	IV/VI	1.9	5.0	129	3/2	27/18	IV/VI	1.4	5.0	138
38	16-8	7-6	111.5	3/3	54/18	IV/VI	1.9	5.0	134	3/2	27/18	IV/VI	1.4	5.0	143
39	16-10	8-3	124.8	3/3	54/18	IV/VI	2.1	4.9	138	3/3	27/18	IV/VI	1.4	5.0	150
40	17-9	3-10	54.4	2/2	54/18	VI/VI	2.0	5.0	113	2/2	27/18	VI/VI	1.4	5.0	127
41	18-2	4-7	68.3	2/2	54/18	VI/VI	2.1	5.0	119	2/2	27/18	VI/VI	1.4	5.0	133
42	18-7	5-4	82.5	2/2	54/18	VI/VI	2.3	5.0	124	2/2	27/18	VI/VI	1.4	5.0	141
43	19-0	6-1	97.1	2/2	54/18	VI/VI	2.5	5.0	130	2/2	27/18	VI/VI	1.4	5.0	148
44	19-5	6-11	111.9	2/2	54/18	VI/VI	2.7	4.7	134	2/2	18/18	VI/VI	1.4	5.0	167
45	19-10	7-8	127.1	2/2	54/18	VI/VI	2.9	4.8	137	2/2	18/18	VI/VI	1.4	5.0	171
46	20-3	8-5	142.6	2/2	27/18	VI/VI	1.9	5.0	160	2/2	18/18	VI/VI	1.4	5.0	175
47	19-1	4-2	63.3	2/2	54/18	VI/VI	2.6	5.0	122	2/2	18/18	VI/VI	1.4	5.0	145
48	19-5	4-11	78.3	2/2	54/18	VI/VI	2.7	5.0	129	2/2	18/18	VI/VI	1.4	5.0	154
49	19-9	5-8	93.6	2/2	54/18	VI/VI	2.9	4.9	133	2/2	18/18	VI/VI	1.4	5.0	163
50	20-1	6-6	109.2	2/2	27/18	VI/VI	1.8	5.0	158	2/2	18/18	VI/VI	1.4	5.0	173
51	20-6	7-3	125.0	2/2	27/18	VI/VI	2.0	5.0	161	2/2	18/18	VI/VI	1.4	5.0	176
52	20-10	8-1	141.2	2/2	27/18	VI/VI	2.1	5.0	165	2/2	18/18	VI/VI	1.4	5.0	180
53	21-2	8-10	157.6	2/2	27/18	VI/VI	2.2	5.0	170	2/2	18/18	VI/VI	1.4	5.0	185
54	20-4	4-6	73.1	2/2	27/18	VI/VI	2.0	5.0	144	2/2	18/18	VI/VI	1.4	5.0	154
55	20-7	5-3	89.2	2/2	27/18	VI/VI	2.0	5.0	152	2/2	18/18	VI/VI	1.4	5.0	163
56	20-11	6-1	105.5	2/2	27/18	VI/VI	2.1	5.0	160	2/2	18/18	VI/VI	1.4	5.0	173
57	21-3	6-10	122.1	2/2	27/18	VI/VI	2.2	5.0	167	2/2	18/18	VI/VI	1.4	5.0	181
58	21-6	7-8	139.0	2/2	27/18	VI/VI	2.3	5.0	171	2/2	18/18	VI/VI	1.4	5.0	185
59	21-10	8-5	156.0	2/2	27/18	VI/VI	2.4	5.0	175	2/2	18/18	VI/VI	1.4	5.0	189
60	22-1	9-3	173.3	2/2	27/18	VI/VI	2.5	4.8	179	2/3	18/18	VI/VI	1.4	5.0	198
61	21-7	4-11	83.8	2/2	27/18	VI/VI	2.3	5.0	154	2/2	18/18	VI/VI	1.4	5.0	163
62	21-10	5-8	101.0	2/2	27/18	VI/VI	2.4	5.0	161	2/2	18/18	VI/VI	1.4	5.0	173
63	22-1	6-6	118.4	2/2	27/18	VI/VI	2.5	4.8	168	2/3	18/18	VI/VI	1.4	5.0	186
64	22-3	7-3	135.9	2/2	27/18	VI/VI	2.5	4.7	176	2/3	18/18	VI/VI	1.4	5.0	196
65	22-6	8-1	153.7	2/2	27/18	VI/VI	2.6	4.4	180	2/3	18/18	VI/VI	1.4	5.0	199
66	22-9	8-10	171.6	2/2	27/18	VI/VI	2.7	4.2	183	2/4	18/18	VI/VI	1.4	5.0	209
67	23-0	9-8	189.8	2/2	27/18	VI/VI	2.8	4.0	187	2/4	18/18	VI/VI	1.4	5.0	213
68	22-9	5-4	95.5	2/2	27/18	VI/VI	2.7	4.2	164	2/4	18/18	VI/VI	1.4	5.0	183
69	23-0	6-1	113.7	2/2	27/18	VI/VI	2.8	4.0	170	2/4	18/18	VI/VI	1.4	5.0	191
70	23-2	6-11	132.1	3/3	27/18	VI/VI	2.6	4.4	191	2/5	18/18	VI/VI	1.4	5.0	206
71	23-4	7-8	150.6	3/3	27/18	VI/VI	2.6	4.3	199	2/5	18/18	VI/VI	1.4	5.0	216
72	23-6	8-6	169.3	3/3	27/18	VI/VI	2.7	4.2	204	2/5	18/18	VI/VI	1.4	5.0	219
73	23-8	9-3	188.1	3/3	27/18	VI/VI	2.7	4.0	208	2/5	18/18	VI/VI	1.4	5.0	224
74	23-10	10-1	207.0	3/3	27/18	VI/VI	2.8	3.9	212	2/5	18/18	VI/VI	1.4	5.0	227
75	24-0	5-9	108.2	2/2	18/18	VI/VI	1.7	5.0	181	2/5	18/18	VI/VI	1.4	5.0	199
76	24-1	6-6	127.5	2/2	18/18	VI/VI	1.7	5.0	191	2/6	18/18	VI/VI	1.4	5.0	214
77	24-3	7-4	146.8	2/2	18/18	VI/VI	1.8	5.0	201	2/6	18/18	VI/VI	1.4	5.0	224
78	24-4	8-2	166.2	2/2	18/18	VI/VI	1.8	5.0	209	2/6	18/18	VI/VI	1.4	5.0	232
79	24-5	8-11	185.7	2/2	18/18	VI/VI	1.8	5.0	213	2/6	18/18	VI/VI	1.4	5.0	236
80	24-7	9-9	205.3	2/2	18/18	VI/VI	1.8	5.0	216	2/6	18/18	VI/VI	1.4	5.0	239
81	24-8	10-6	225.0	2/2	18/18	VI/VI	1.8	5.0	221	2/6	18/18	VI/VI	1.4	5.0	244
82	25-2	6-2	122.0	2/2	18/18	VI/VI	1.9	4.9	191	2/6	18/18	VI/VI	1.4	5.0	214
83	25-2	7-0	142.2	2/2	18/18	VI/VI	1.9	4.9	201	2/7	18/18	VI/VI	1.4	5.0	230
84	25-3	7-9	162.4	2/2	18/18	VI/VI	1.9	4.9	209	2/7	18/18	VI/VI	1.4	5.0	238
85	25-4	8-7	182.6	2/2	18/18	VI/VI	1.9	4.8	219	2/7	18/18	VI/VI	1.4	5.0	248
86	25-4	9-5	202.9	2/2	18/18	VI/VI	1.9	4.8	222	2/7	18/18	VI/VI	1.4	5.0	251
87	25-5	10-2	223.3	2/2	18/18	VI/VI</									

TABLE 49C. ALBC STRUCTURE AREA, PLATE AND RIB MAKE-UP

Box #	Inside Dimensions		Total (N)	Crown			Haunch		Straight Leg Length D (N)	Side Angle E (deg.)	Box #	Inside Dimensions		Total (N)	Crown			Haunch		Straight Leg Length D (N)	Side Angle E (deg.)
	Span (Ft.-In.)	Rise (Ft.-In.)		Arc Length (N)	Plate (N)	Rib Lengths Long/Short (N)	Plate (N)	Rib Length (N)				Span (Ft.-In.)	Rise (Ft.-In.)		Arc Length (N)	Plate (N)	Rib Lengths Long/Short (N)	Plate (N)	Rib Length (N)		
1	8-9	2-6	14		NA		14	5.5	.5		68	22-9	5-4	34			10	6.5	.5		
2	9-2	3-3	16				8	6.5	1.5		69	23-0	6-1	36			11	7.5	1.5		
3	9-7	4-1	18				9	7.5	2.5		70	23-2	6-11	38			12	8.5	2.5		
4	10-0	4-10	20				10	7.5	3.5		71	23-4	7-8	40			13	9.5	3.5		
5	10-6	5-7	22				11	7.5	4.5		72	23-6	8-6	42			14	9.5	4.5		
6	10-11	6-4	24				12	7.5	5.5		73	23-8	9-3	44			15	9.5	5.5		
7	11-4	7-2	26				13	7.5	6.5		74	23-10	10-1	46			16	9.5	6.5		
8	10-2	2-8	16				8	6.5	.5		75	24-0	5-9	36			10	6.5	.5		
9	10-7	3-5	18				9	7.5	1.5		76	24-1	6-6	38			11	7.5	1.5		
10	10-11	4-3	20				10	8.5	2.5		77	24-3	7-4	40			12	8.5	2.5		
11	11-4	5-0	22				11	8.5	3.5		78	24-4	8-2	42			13	9.5	3.5		
12	11-8	5-9	24				12	8.5	4.5		79	24-5	8-11	44			14	9.5	4.5		
13	12-1	6-7	26				13	8.5	5.5		80	24-7	9-9	46			15	9.5	5.5		
14	12-5	7-4	28				14	8.5	6.5		81	24-8	10-6	48			16	9.5	6.5		
15	11-7	2-10	18				9	6.5	.5		82	25-2	6-2	38			11	6.5	.5		
16	11-11	3-7	20				10	7.5	1.5		83	25-2	7-0	40			12	7.5	1.5		
17	12-3	4-5	22				11	8.5	2.5		84	25-3	7-9	42			13	8.5	2.5		
18	12-7	5-2	24				12	8.5	3.5		85	25-4	8-7	44			14	9.5	3.5		
19	12-11	6-0	26				13	8.5	4.5		86	25-4	9-5	46			15	9.5	4.5		
20	13-3	6-9	28				14	8.5	5.5		87	25-5	10-2	48			16	9.5	5.5		
21	13-0	3-0	20				10	6.5	.5		88	26-7	5-5	38			11	6.5	.5		
22	13-4	3-10	22				11	7.5	1.5		89	27-0	6-3	40			12	7.5	1.5		
23	13-7	4-7	24				12	8.5	2.5		90	27-5	7-0	42			13	8.5	2.5		
24	13-10	5-5	26				13	8.5	3.5		91	27-10	7-9	44			14	9.5	3.5		
25	14-1	6-2	28				14	8.5	4.5		92	28-3	8-7	46			15	9.5	4.5		
26	14-5	3-3	22				11	6.5	.5		93	28-8	9-4	48			16	9.5	5.5		
27	14-8	4-1	24				8	7.5	1.5		94	29-2	10-1	50			17	9.5	6.5		
28	14-10	4-10	26				9	8.5	2.5		95	27-10	5-10	40			12	7.5	.5		
29	15-1	5-8	28				10	8.5	3.5		96	28-3	6-8	42			13	8.5	1.5		
30	15-4	6-5	30				11	8.5	4.5		97	28-7	7-5	44			14	9.5	2.5		
31	15-6	7-3	32				12	8.5	5.5		98	29-0	8-3	46			15	10.5	3.5		
32	15-9	8-0	34				13	8.5	6.5		99	29-4	9-0	48			16	10.5	4.5		
33	15-10	3-6	24				8	6.5	.5		100	29-8	9-9	50			17	10.5	5.5		
34	16-0	4-3	26				9	7.5	1.5		101	30-1	10-7	52			18	10.5	6.5		
35	16-2	5-1	28				10	8.5	2.5		102	29-1	6-4	42			12	8.5	.5		
36	16-4	5-11	30				11	8.5	3.5		103	29-5	7-1	44			13	9.5	1.5		
37	16-6	6-8	32				12	8.5	4.5		104	29-8	7-11	46			14	10.5	2.5		
38	16-8	7-6	34				13	8.5	5.5		105	30-0	8-8	48			15	11.5	3.5		
39	16-10	8-3	36				14	8.5	6.5		106	30-4	9-5	50			16	11.5	4.5		
40	17-9	3-10	26				8	6.5	.5		107	30-8	10-3	52			17	11.5	5.5		
41	18-2	4-7	28				9	7.5	1.5		108	31-0	11-0	54			18	11.5	6.5		
42	18-7	5-4	30				10	8.5	2.5		109	30-3	6-9	44			13	8.5	.5		
43	19-0	6-1	32				11	9.5	3.5		110	30-6	7-7	46			14	9.5	1.5		
44	19-5	6-11	34				12	9.5	4.5		111	30-10	8-4	48			15	10.5	2.5		
45	19-10	7-8	36				13	9.5	5.5		112	31-1	9-2	50			16	11.5	3.5		
46	20-3	8-5	38				14	9.5	6.5		113	31-4	9-11	52			17	11.5	4.5		
47	19-1	4-2	28				8	6.5	.5		114	31-8	10-9	54			18	11.5	5.5		
48	19-5	4-11	30				9	7.5	1.5		115	31-11	11-6	56			19	11.5	6.5		
49	19-9	5-8	32				10	8.5	2.5		116	31-5	7-3	46			14	8.5	.5		
50	20-1	6-6	34				11	9.5	3.5		117	31-8	8-0	48			15	9.5	1.5		
51	20-6	7-3	36				12	9.5	4.5		118	31-10	8-10	50			16	10.5	2.5		
52	20-10	8-1	38				13	9.5	5.5		119	32-1	9-8	52			17	11.5	3.5		
53	21-2	8-10	40				14	9.5	6.5		120	32-3	10-5	54			18	11.5	4.5		
54	20-4	4-6	30				8	6.5	.5		121	32-7	11-3	56			19	11.5	5.5		
55	20-7	5-3	32				9	7.5	1.5		122	32-8	12-0	58			20	11.5	6.5		
56	20-11	6-1	34				10	8.5	2.5		123	32-7	7-9	48			14	8.5	.5		
57	21-3	6-10	36				11	9.5	3.5		124	32-9	8-6	50			15	9.5	1.5		
58	21-6	7-8	38				12	9.5	4.5		125	32-11	9-4	52			16	10.5	2.5		
59	21-10	8-5	40				13	9.5	5.5		126	33-1	10-2	54			17	11.5	3.5		
60	22-1	9-3	42				14	9.5	6.5		127	33-3	10-11	56			18	11.5	4.5		
61	21-7	4-11	32				9	6.5	.5		128	33-5	11-9	58			19	11.5	5.5		
62	21-10	5-8	34				10	7.5	1.5		129	33-8	12-6	60			20	11.5	6.5		
63	22-1	6-6	36				11	8.5	2.5		130	33-8	8-3	50			15	8.5	.5		
64	22-3	7-3	38				12	9.5	3.5		131	33-9	9-1	52			16	9.5	1.5		
65	22-6	8-1	40				13	9.5	4.5		132	33-11	9-10	54			17	10.5	2.5		
66	22-9	8-10	42				14	9.5	5.5		133	34-0	10-8	56			18	11.5	3.5		
67	23-0	9-8	44				15	9.5	6.5		134	34-2	11-5	58			19	11.5	4.5		
											135	34-3	12-3	60			20	11.5	5.5		
											136	34-5	13-1	62			21	11.5	6.5		
											137	34-9	8-9	52			16	8.5	.5		
											138	34-10	9-7	54			17	9.5	1.5		
											139	34-11	10-4	56			18	10.5	2.5		
											140	35-0	11-2	58			19	11.5	3.5		
											141	35-1	12-0	60			20	11.5	4.5		
											142	35-2	12-9	62			21	11.5	5.5		
											143	35-3	13-7	64			22	11.5	6.5		

Notes: Box #1 is a one plate shell.
See page 63 for "D" and "E" designations.

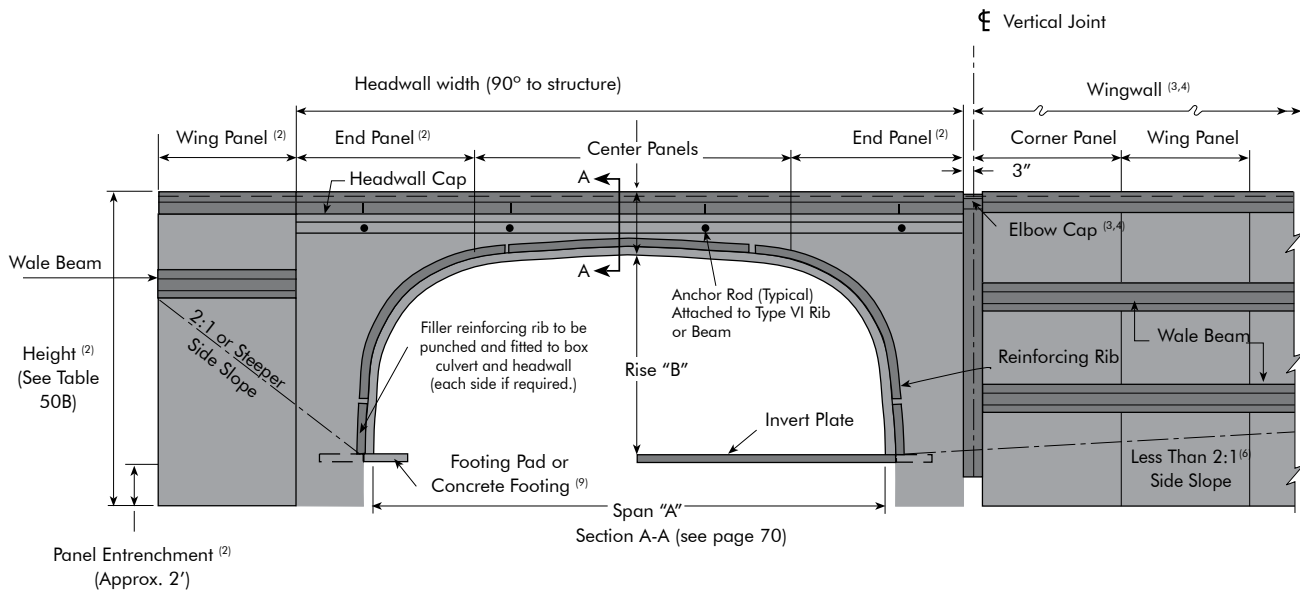

ALBC Headwall and Wingwall Details

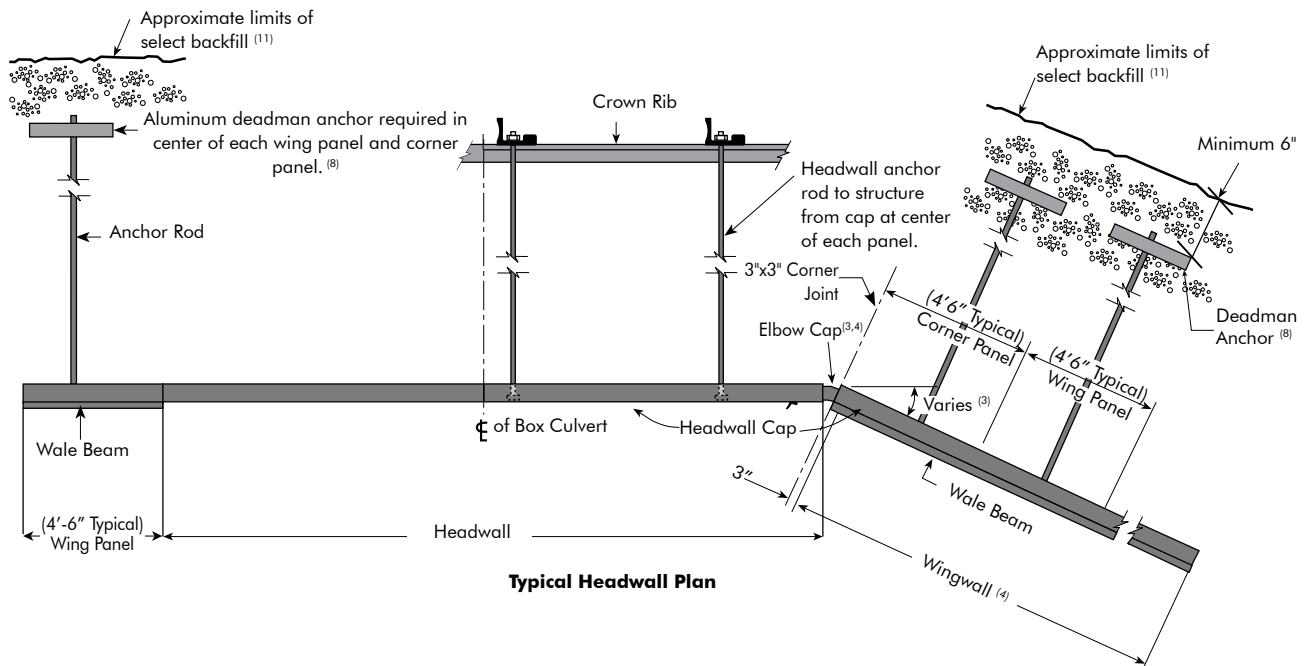

Typical Headwall Plan

Notes:

1. All panels are fabricated from aluminum structural plate as specified in ASTM B746.
2. Height of headwall listed in Table 50B permits approximately 24" entrenchment depth below the invert. All wingwall and headwall end panels must be trenched into existing ground.
3. Horizontal rotation on the wingwall should not exceed 90°.
4. The top of a headwall and its wingwall are always horizontal, unless beveled wingwalls are required.
5. Standard headwalls shown are for vertical orientation only.
6. If side slope is flatter than 2:1, a double tieback assembly is required for each deadman.
7. Standard headwalls are shown. HL-93, HS-20 and HS-25 wheel loads must be kept a minimum distance of 36" from the wall face. Special headwall packages can be fabricated to meet other loading requirements.
8. For details on single and dual deadman anchors, refer to next page.
9. Structures on concrete footings with headwalls require field modification of the headwall plates to fit around the footings.
10. Aluminum headwalls may be used only on square-ended structures. Structure length must be an increment of 9 inches, if these headwalls are utilized at both ends.
11. If an aluminum headwall and/or wingwall system is specified, the select granular structural backfill shall extend past the deadman anchor system a minimum of 6". Contact your Contech representative if stiff material or rock is encountered where the wingalls and deadman are to be installed.

TABLE 50A. HEADWALL AND WINGWALL DETAILS

Wall Height (Ft.-In.)	Headwall			Wingwalls						0.150" thick Deadman Size	3/4" Dia. Rod Length Min. (Ft.-In.)
	Center Panel Thickness	End Panel Thickness	Wale Beam - Distance from top of HW (Ft.-In.)	Single Anchor		Dual Anchor		Triple Anchors			
				Panel Thickness	"D" Wale Beam - Distance from top of HW Cap (Ft.-In.)	Panel Thickness	"D" Wale Beam - Distance see detail (Ft.-In.)	Panel Thickness	"D" Wale Beam - Distance from top of HW Cap (Ft.-In.)		
6-2 to 8-7	0.125"	0.150"	N/A	0.125"	3-0	N/A	N/A	N/A	N/A	18" x 2' 4 3/4"	12-6
9-4 to 11-9	0.125"	0.150"	N/A	0.150"	3-6	0.125"	3-0	N/A	N/A	18" x 2' 4 3/4"	12-6
12-7 to 14-2	0.125"	0.150"	N/A	N/A	N/A	0.150"	3-8	N/A	N/A	18" x 2' 4 3/4"	12-6
14-11	0.175"	0.175"	7-3 & 12-3	N/A	N/A	N/A	N/A	0.175"	3-6, 8-0, 12-9	32" x 2' 5 1/2"	20-0
15-9	0.175"	0.175"	7-6 & 12-8	N/A	N/A	N/A	N/A	0.175"	3-6, 8-0, 12-9	32" x 2' 5 1/2"	20-0
16-7	0.200"	0.200"	7-6, 12-8, 14-0	N/A	N/A	N/A	N/A	0.200"	3-9, 8-9, 13-8	32" x 2' 5 1/2"	20-0
17-4	0.200"	0.200"	7-6, 12-8, 15-0	N/A	N/A	N/A	N/A	0.200"	3-9, 8-9, 13-8	32" x 2' 5 1/2"	20-0
18-2	0.200"	0.200"	7-6, 12-8, 15-0	N/A	N/A	N/A	N/A	0.225"	3-9, 8-9, 13-8	32" x 2' 5 1/2"	20-0

Notes:

1. Any wall heights greater than 18'-2": Inquire
2. HW = Headwall, WW = Wingwall

HEADWALL ATTACHMENT TO CROWN

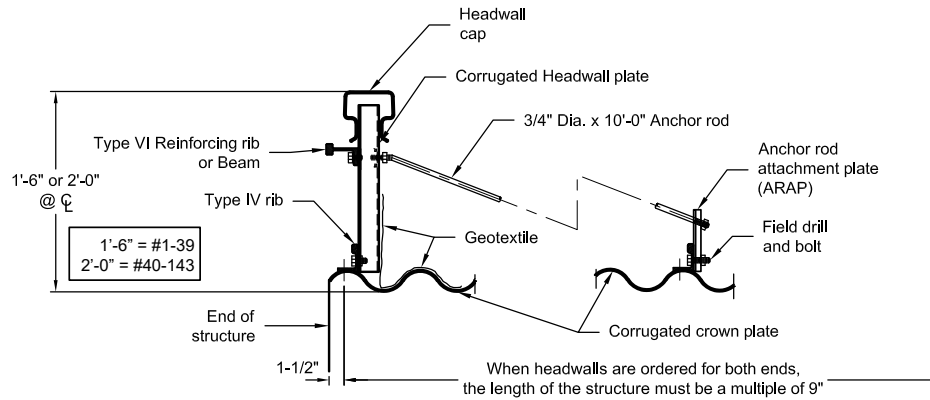

WINGWALL SINGLE ANCHOR DESIGN

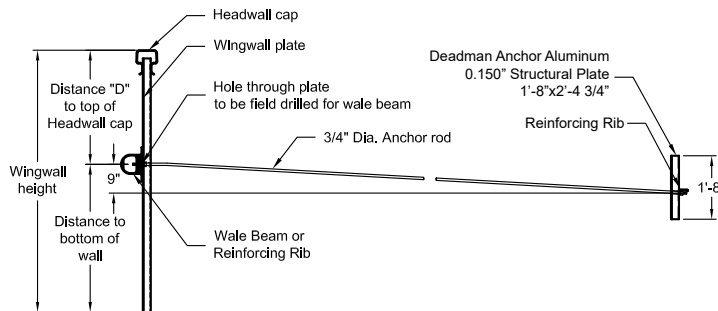

WINGWALL DUAL ANCHOR DESIGN

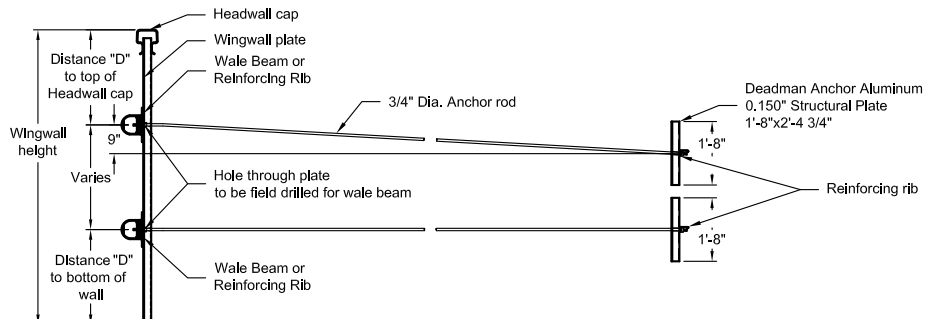

Note: Triple anchor design required wall heights greater than 14'-2". See table above for additional options.

Headwall Dimensions for HL-93, H-20, HS-20, H-25, HS-25 Loading

TABLE 50B. HEADWALL

No.	Width (Ft.-In.)	Height (Ft.-In.)	No. of Anchor Rods	No.	Width (Ft.-In.)	Height (Ft.-In.)	No. of Anchor Rods
1	13-6	6-2	3	88	33-0	9-4	7
2	13-6	6-11	3	89	33-0	10-11	7
3	13-6	7-9	3	90	33-0	10-11	7
4	13-6	8-6	3	91	33-0	11-9	7
5	13-6	9-4	3	92	33-0	12-7	7
6	13-6	10-2	3	93	33-0	13-4	7
7	13-6	10-11	3	94	33-0	14-2	7
8	15-0	6-2	3	95	34-6	10-2	8
9	15-0	6-11	3	96	34-6	10-11	8
10	15-0	7-9	3	97	34-6	11-9	8
11	15-0	8-6	3	98	34-6	12-7	8
12	15-0	9-4	3	99	34-6	13-4	8
13	15-0	10-2	3	100	34-6	14-2	8
14	15-0	10-11	3	101	34-6	14-11	8
15	16-6	6-11	4	102	36-0	10-11	8
16	16-6	7-9	4	103	36-0	11-9	8
17	16-6	8-6	4	104	36-0	12-7	8
18	16-6	9-4	4	105	36-0	13-4	8
19	16-6	10-2	4	106	36-0	13-4	8
20	16-6	10-11	4	107	36-0	14-2	8
21	18-0	6-11	4	108	36-0	14-11	8
22	18-0	7-9	4	109	37-6	10-11	8
23	18-0	8-6	4	110	37-6	11-9	8
24	18-0	9-4	4	111	37-6	12-7	8
25	18-0	10-2	4	112	37-6	13-4	8
26	19-6	6-11	4	113	37-6	14-2	8
27	19-6	7-9	4	114	37-6	14-11	8
28	19-6	8-6	4	115	37-6	15-9	8
29	19-6	9-4	4	116	37-6	11-9	8
30	19-6	10-2	4	117	37-6	12-7	8
31	19-6	10-11	4	118	37-6	13-4	8
32	19-6	11-9	4	119	37-6	14-2	8
33	21-0	6-11	5	120	37-6	14-11	8
34	21-0	7-9	5	121	37-6	15-9	8
35	21-0	8-6	5	122	37-6	16-7	8
36	21-0	9-4	5	123	37-6	11-9	8
37	21-0	10-2	5	124	37-6	12-7	8
38	21-0	10-11	5	125	37-6	13-4	8
39	21-0	11-9	5	126	37-6	14-2	8
40	22-6	7-9	5	127	37-6	14-11	8
41	22-6	8-6	5	128	37-6	15-9	8
42	22-6	9-4	5	129	37-6	16-7	8
43	22-6	10-2	5	130	40-6	12-7	9
44	22-6	10-11	5	131	40-6	13-4	9
45	22-6	11-9	5	132	40-6	14-2	9
46	22-6	12-7	5	133	40-6	14-11	9
47	24-0	8-6	5	134	40-6	15-9	9
48	24-0	9-4	5	135	40-6	16-7	9
49	24-0	10-2	5	136	40-6	17-4	9
50	24-0	10-11	5	137	42-0	13-4	9
51	24-0	11-9	5	138	42-0	14-2	9
52	24-0	12-7	5	139	42-0	14-11	9
53	24-0	13-4	5	140	42-0	15-9	9
54	25-6	8-6	6	141	42-0	16-7	9
55	25-6	9-4	6	142	42-0	17-4	9
56	25-6	10-2	6	143	42-0	18-2	9
57	25-6	10-11	6				
58	25-6	11-9	6				
59	25-6	12-7	6				
60	25-6	13-4	6				
61	27-0	9-4	6				
62	27-0	10-2	6				
63	27-0	10-11	6				
64	27-0	11-9	6				
65	27-0	12-7	6				
66	27-0	13-4	6				
67	27-0	14-2	6				
68	28-6	9-4	6				
69	28-6	10-2	6				
70	28-6	10-11	6				
71	28-6	11-9	6				
72	28-6	12-7	6				
73	28-6	13-4	6				
74	28-6	14-2	6				
75	30-0	10-2	7				
76	30-0	10-11	7				
77	30-0	11-9	7				
78	30-0	12-7	7				
79	30-0	13-4	7				
80	30-0	14-2	7				
81	30-0	14-11	7				
82	31-6	10-2	7				
83	31-6	10-11	7				
84	31-6	11-9	7				
85	31-6	12-7	7				
86	31-6	13-4	7				
87	31-6	14-2	7				



Aluminum Box Culvert with Full Aluminum Headwall Package

Aluminum Box Culvert

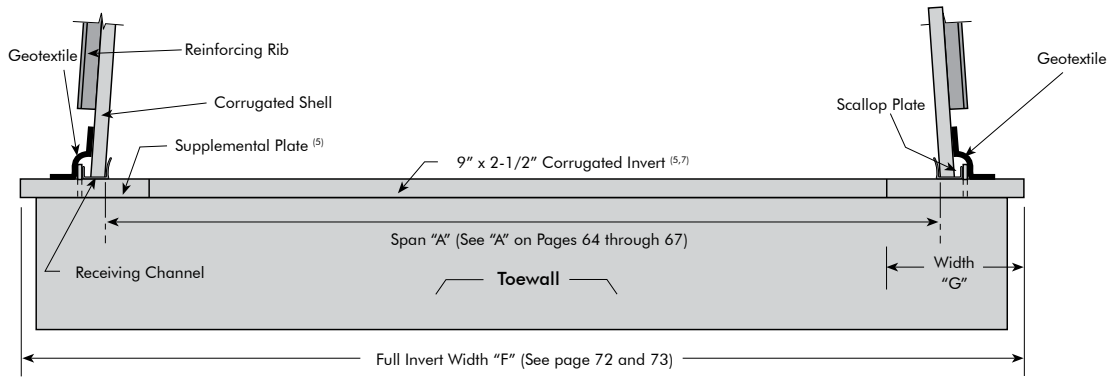

Aluminum Full Invert Option

Notes:

1. $N=9.625$ " or $9 \frac{5}{8}$ ". Use N as a conversion factor. For example, for Structure No. 1, Width "F" is $13 \times N$, or 125.13".
2. Minimum allowable (unfactored) soil-bearing pressure is 4,000 psf for structures and details shown in this catalog. This applies specifically for width "G" below the receiving channel. Other conditions can be accommodated. Contact a Contech Representative for more information.
3. The maximum cover for Aluminum Box Culverts with full inverts and footing pads should not exceed 4 feet. Special full invert and footing pad designs or slotted concrete footings can accommodate maximum covers to the limits shown in Tables 48A-48B and 49A-49B.
4. Weight per foot of full invert includes receiving channels, scallop plates, nuts, bolts, and all plates.
5. Full invert plates thickness are as shown. When reactions to the invert require additional thickness, supplemental plates of the thickness and width listed in Table 51 are furnished to bolt between the full invert and the receiving channel.
6. Invert widths 21N and greater are two-pieces.
7. Invert plates must not be overlapped on adjacent structures unless appropriate design modifications are incorporated.
8. Bent sheet toewalls are supplied for structures having a full corrugated aluminum invert.

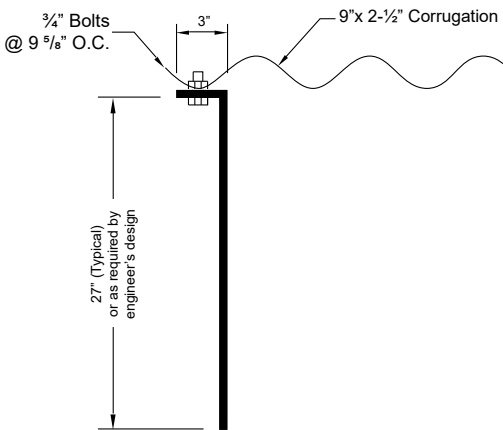

Aluminum Bent Sheet Toewall Detail

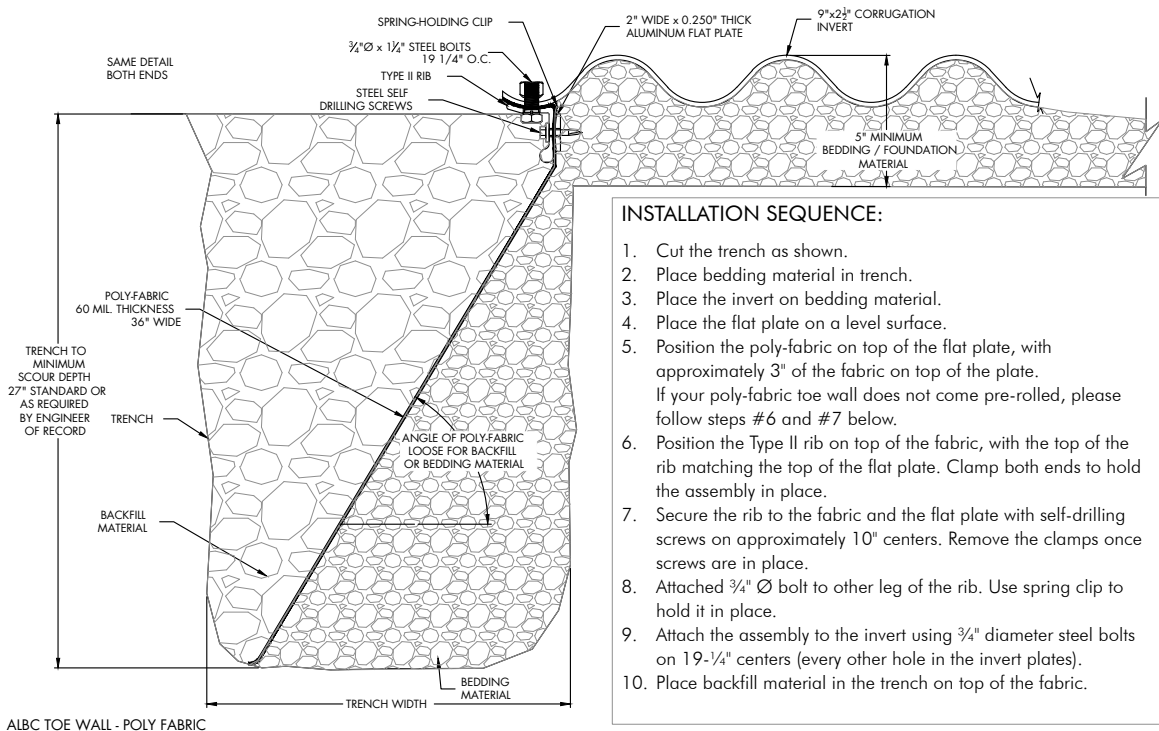

- INSTALLATION SEQUENCE:**
1. Cut the trench as shown.
 2. Place bedding material in trench.
 3. Place the invert on bedding material.
 4. Place the flat plate on a level surface.
 5. Position the poly-fabric on top of the flat plate, with approximately 3" of the fabric on top of the plate. If your poly-fabric toe wall does not come pre-rolled, please follow steps #6 and #7 below.
 6. Position the Type II rib on top of the fabric, with the top of the rib matching the top of the flat plate. Clamp both ends to hold the assembly in place.
 7. Secure the rib to the fabric and the flat plate with self-drilling screws on approximately 10" centers. Remove the clamps once screws are in place.
 8. Attached $\frac{3}{4}$ " \varnothing bolt to other leg of the rib. Use spring clip to hold it in place.
 9. Attach the assembly to the invert using $\frac{3}{4}$ " diameter steel bolts on 19- $\frac{1}{4}$ " centers (every other hole in the invert plates).
 10. Place backfill material in the trench on top of the fabric.

Poly-Fabric Toewall Detail

Full Invert Details

TABLE 51A FULL INVERT DETAILS (H-20, HS-20)					
Structure No.	Width "F" (N)	Supplemental Plate Thickness (Inches)	Width "G" (N)	Weight/Ft. (Lbs.)	Bolts/Ft. (Each)
1	13		2	25.9	5.8
2	14		2	27.3	6.0
3	14		2	27.3	6.0
4	15		2	28.8	6.2
5	16		2	30.2	6.4
6	16		2	30.2	6.4
7	17		2	31.7	6.7
8	15		2	28.8	6.2
9	16		2	30.2	6.4
10	16		2	30.2	6.4
11	17		2	31.7	6.7
12	17		2	31.7	6.7
13	18		2	33.1	6.9
14	18		2	33.1	6.9
15	17		2	31.7	6.7
16	17		2	31.7	6.7
17	18		2	33.1	6.9
18	18		2	33.1	6.9
19	19		2	34.6	7.1
20	19		2	34.6	7.1
21	19		2	34.6	7.1
22	19		2	34.6	7.1
23	19		2	34.6	7.1
24	20		2	36.0	7.3
25	20		2	36.0	7.3
26	20	.100	2	41.3	7.3
27	21	.100	2	46.4	12.9
28	21	.100	2	46.4	12.9
29	21	.100	2	46.4	12.9
30	22	.100	2	47.8	13.1
31	22	.100	2	47.8	13.1
32	22	.100	2	47.8	13.1
33	22	.100	2	47.8	13.1
34	22	.100	2	47.8	13.1
35	23	.100	2	49.3	13.3
36	23	.100	2	49.3	13.3
37	23	.100	2	49.3	13.3
38	23	.100	2	49.3	13.3
39	24	.100	2	50.7	13.6
40	26	.100	3	56.3	14.0
41	26	.100	3	56.3	14.0
42	27	.100	3	57.7	14.2
43	27	.100	3	57.7	14.2
44	28	.100	3	59.2	14.4
45	28	.100	3	59.2	14.4
46	29	.100	3	60.6	14.7
47	27	.100	3	57.7	14.2
48	28	.100	3	59.2	14.4
49	28	.100	3	59.2	14.4
50	29	.100	3	60.6	14.7
51	29	.100	3	60.6	14.7
52	29	.125	3	62.6	14.7
53	30	.125	3	64.0	14.9
54	29	.125	3	62.6	14.7
55	29	.125	3	62.6	14.7
56	30	.125	3	64.0	14.9
57	30	.125	3	64.0	14.9
58	30	.125	3	64.0	14.9
59	31	.125	3	65.5	15.1
60	31	.125	3	65.5	15.1
61	30	.125	3	64.0	14.9
62	31	.125	3	65.5	15.1
63	31	.150	3	67.5	15.1
64	31	.150	3	67.5	15.1
65	32	.150	3	68.9	15.3
66	32	.150	3	68.9	15.3
67	32	.150	3	68.9	15.3
68	32	.150	3	68.9	15.3
69	32	.150	3	68.9	15.3
70	32	.150	3	68.9	15.3
71	33	.150	3	70.4	15.6
72	33	.150	3	70.4	15.6
73	33	.150	3	70.4	15.6
74	33	.150	3	70.4	15.6
75	33	.150	3	70.4	15.6
76	34	.175	3	73.8	15.8
77	34	.175	3	73.8	15.8
78	34	.175	3	73.8	15.8
79	34	.175	3	73.8	15.8
80	34	.175	3	73.8	15.8
81	34	.175	3	73.8	15.8
82	35	.200	3.5	79.9	16.0
83	35	.200	3.5	79.9	16.0
84	35	.200	3.5	79.9	16.0
85	36	.200	3.5	81.4	16.2
86	36	.200	3.5	81.4	16.2
87	36	.200	3.5	81.4	16.2

TABLE 51B FULL INVERT DETAILS (HL-93, H-25, HS-25)					
Structure No.	Width "F" (N)	Supplemental Plate Thickness (Inches)	Width "G" (N)	Weight/Ft. (Lbs.)	Bolts/Ft. (Each)
1	13		2	25.9	5.8
2	14		2	27.3	6.0
3	14		2	27.3	6.0
4	15		2	28.8	6.2
5	16		2	30.2	6.4
6	16		2	30.2	6.4
7	17		2	31.7	6.7
8	15		2	28.8	6.2
9	16		2	30.2	6.4
10	16		2	30.2	6.4
11	17		2	31.7	6.7
12	17		2	31.7	6.7
13	18	.100	2	38.4	6.9
14	18	.100	2	38.4	6.9
15	17	.100	2	37.0	6.7
16	17	.100	2	37.0	6.7
17	18	.100	2	38.4	6.9
18	18	.100	2	38.4	6.9
19	19	.100	2	39.9	7.1
20	19	.100	2	39.9	7.1
21	19	.100	2	39.9	7.1
22	19	.100	2	39.9	7.1
23	19	.100	2	39.9	7.1
24	20	.100	2	41.3	7.3
25	20	.100	2	41.3	7.3
26	20	.100	2	41.3	7.3
27	21	.100	2	46.4	12.9
28	21	.100	2	46.4	12.9
29	21	.100	2	46.4	12.9
30	22	.100	2	47.8	13.1
31	22	.100	2	47.8	13.1
32	22	.100	2	47.8	13.1
33	22	.100	2	47.8	13.1
34	22	.100	2	47.8	13.1
35	23	.100	2	49.3	13.3
36	23	.100	2	49.3	13.3
37	23	.100	2	49.3	13.3
38	23	.100	2	49.3	13.3
39	24	.100	3	53.4	13.6
40	26	.150	3	60.2	14.0
41	26	.150	3	60.2	14.0
42	27	.150	3	61.7	14.2
43	27	.150	3	61.7	14.2
44	28	.150	3	63.1	14.4
45	28	.150	3	63.1	14.4
46	29	.150	3	64.6	14.7
47	27	.150	3	61.7	14.2
48	28	.150	3	63.1	14.4
49	28	.150	3	63.1	14.4
50	29	.150	3	64.6	14.7
51	29	.150	3	64.6	14.7
52	29	.150	3	64.6	14.7
53	30	.175	3	68.0	14.9
54	29	.175	3	66.6	14.7
55	29	.175	3	66.6	14.7
56	30	.175	3	68.0	14.9
57	30	.175	3	68.0	14.9
58	30	.175	3	68.0	14.9
59	31	.175	3	69.5	15.1
60	31	.175	3	69.5	15.1
61	30	.175	3	68.0	14.9
62	31	.175	3	69.5	15.1
63	31	.175	3	69.5	15.1
64	31	.175	3	69.5	15.1
65	32	.175	3	70.9	15.3
66	32	.175	3	70.9	15.3
67	32	.175	3	70.9	15.3
68	32	.175	3	70.9	15.3
69	32	.175	3	70.9	15.3
70	32	.175	3	70.9	15.3
71	33	.175	3	72.4	15.6
72	33	.175	3	72.4	15.6
73	33	.175	3	72.4	15.6
74	33	.175	3	72.4	15.6
75	33	.200	3	74.4	15.6
76	34	.200	3	75.8	15.8
77	34	.200	3	75.8	15.8
78	34	.200	3	75.8	15.8
79	34	.200	3	75.8	15.8
80	34	.200	3	75.8	15.8
81	34	.200	3	75.8	15.8
82	35	.250	3.5	84.6	16.0
83	35	.250	3.5	84.6	16.0
84	35	.250	3.5	84.6	16.0
85	36	.250	3.5	86.0	16.2
86	36	.250	3.5	86.0	16.2
87	36	.250	3.5	86.0	16.2

Note:
1. For structures 1-87, invert plates are 0.100" thick.

Aluminum Box Culvert

TABLE 51C. FULL INVERT DETAILS (HL-93, H-25, HS-25)

Structure No.	Invert Plate Thickness (Inches)	Invert Width (N)	Supplemental Plate Thickness (Inches)	Supplemental Plate Quantity	Supplemental Plate Width (N)	Weight (Lbs.-Ft.)	Bolts/Ft.
88	0.125	37	0.175	2	4	114.0	16.4
89	0.125	38	0.175	2	4	115.8	16.7
90	0.125	38	0.175	2	4	115.8	16.7
91	0.125	39	0.175	2	4	117.6	16.9
92	0.125	40	0.175	2	4	119.3	17.1
93	0.125	40	0.175	2	4	119.3	17.1
94	0.125	40	0.175	2	4	119.3	17.1
95	0.125	39	0.175	2	4	117.6	16.9
96	0.125	39	0.175	2	4	117.6	16.9
97	0.125	40	0.175	2	4	119.3	17.1
98	0.125	40	0.175	2	4	119.3	17.1
99	0.125	41	0.175	2	4	121.1	17.3
100	0.125	41	0.175	2	4	121.1	17.3
101	0.125	42	0.250	2	6	165.4	17.6
102	0.125	40	0.250	2	6	161.8	17.1
103	0.125	41	0.250	2	6	163.6	17.3
104	0.125	41	0.250	2	6	163.6	17.3
105	0.125	42	0.250	2	6	165.4	17.6
106	0.125	44	0.250	2	6	168.9	18.0
107	0.125	45	0.250	2	6	170.7	18.2
108	0.125	45	0.250	2	6	170.7	18.2
109	0.125	44	0.250	2	6	168.9	18.0
110	0.125	44	0.250	2	6	168.9	18.0
111	0.125	45	0.250	2	6	170.7	18.2
112	0.125	45	0.250	2	6	170.7	18.2
113	0.125	45	0.250	2	6	170.7	18.2
114	0.125	46	0.250	2	6	172.5	18.4
115	0.125	46	0.250	2	6	172.5	18.4
116	0.125	45	0.250	2	6	170.7	18.2
117	0.125	46	0.250	2	6	172.5	18.4
118	0.125	46	0.250	2	6	172.5	18.4
119	0.125	46	0.250	2	6	172.5	18.4
120	0.125	47	0.250	2	6	174.3	18.7
121	0.125	47	0.250	2	6	174.3	18.7
122	0.125	47	0.250	3	6	214.1	18.7
123	0.125	47	0.250	3	6	214.1	18.7
124	0.125	47	0.250	3	6	214.1	18.7
125	0.125	47	0.250	3	6	214.1	18.7
126	0.125	48	0.250	3	6	215.9	18.9
127	0.125	48	0.250	3	6	215.9	18.9
128	0.125	48	0.250	3	6	215.9	18.9
129	0.125	48	0.250	3	6	215.9	18.9
130	0.125	48	0.250	3	6	215.9	18.9
131	0.125	48	0.250	3	6	215.9	18.9
132	0.125	49	0.250	3	6	217.6	19.1
133	0.125	49	0.250	3	6	217.6	19.1
134	0.125	49	0.250	3	6	217.6	19.1
135	0.125	49	0.250	3	6	217.6	19.1
136	0.125	49	0.250	3	6	217.6	19.1
137	0.125	49	0.250	3	6	217.6	19.1
138	0.125	50	0.250	3	6	219.4	19.3
139	0.125	50	0.250	3	6	219.4	19.3
140	0.125	50	0.250	3	6	219.4	19.3
141	0.125	50	0.250	3	6	219.4	19.3
142	0.125	50	0.250	3	6	219.4	19.3
143	0.125	50	0.250	3	6	219.4	19.3

Aluminum Box Culvert



Assembly of ALBC Shell onto Full Invert

TABLE 52A. FOOTING PAD DETAILS

Structure No.	H-20, HS-20 Loading				HL-93, H-25, HS-25 Loading			
	Plate Thickness (Inches)	Width "G" (N)	Weight (Lbs.- Ft.)	Bolts-Ft.	Plate Thickness (Inches)	Width "G" (N)	Weight (Lbs.- Ft.)	Bolts-Ft.
1	0.100	2	12.4	3.3	0.100	2	12.4	3.3
2	0.100	2	12.4	3.3	0.100	2	12.4	3.3
3	0.100	2	12.4	3.3	0.100	2	12.4	3.3
4	0.100	2	18.5	4.2	0.100	2	18.5	4.2
5	0.100	2	18.5	4.2	0.100	2	18.5	4.2
6	0.100	2	18.5	4.2	0.100	2	18.5	4.2
7	0.100	2	18.5	4.2	0.100	2	18.5	4.2
8	0.100	2	12.4	3.3	0.100	2	12.4	3.3
9	0.100	2	12.4	3.3	0.100	2	12.4	3.3
10	0.100	2	12.4	3.3	0.100	2	12.4	3.3
11	0.100	2	18.5	4.2	0.100	2	18.5	4.2
12	0.100	2	18.5	4.2	0.100	2	18.5	4.2
13	0.100	2	18.5	4.2	0.125	2	20.1	4.2
14	0.100	2	18.5	4.2	0.125	2	20.1	4.2
15	0.100	2	12.4	3.3	0.125	2	14.0	3.3
16	0.100	2	12.4	3.3	0.125	2	14.0	3.3
17	0.100	2	12.4	3.3	0.125	2	14.0	3.3
18	0.100	2	18.5	4.2	0.125	2	20.1	4.2
19	0.100	2	18.5	4.2	0.125	2	20.1	4.2
20	0.100	2	18.5	4.2	0.125	2	20.1	4.2
21	0.100	2	12.4	3.3	0.125	2	14.0	3.3
22	0.100	2	12.4	3.3	0.125	2	14.0	3.3
23	0.100	2	12.4	3.3	0.125	2	14.0	3.3
24	0.100	2	18.5	4.2	0.125	2	20.1	4.2
25	0.100	2	18.5	4.2	0.125	2	20.1	4.2
26	0.125	2	14.0	3.3	0.150	2	15.7	3.3
27	0.125	2	14.0	3.3	0.150	2	15.7	3.3
28	0.125	2	14.0	3.3	0.150	2	15.7	3.3
29	0.125	2	20.1	4.2	0.150	2	21.8	4.2
30	0.125	2	20.1	4.2	0.150	2	21.8	4.2
31	0.125	2	20.1	4.2	0.150	2	21.8	4.2
32	0.125	2	20.1	4.2	0.150	2	21.8	4.2
33	0.125	2	14.0	3.3	0.150	2	15.7	3.3
34	0.125	2	14.0	3.3	0.150	2	15.7	3.3
35	0.125	2	14.0	3.3	0.150	2	15.7	3.3
36	0.125	2	20.1	4.2	0.150	2	21.8	4.2
37	0.125	2	20.1	4.2	0.150	2	21.8	4.2
38	0.125	2	20.1	4.2	0.150	2	21.8	4.2
39	0.125	2	20.1	4.2	0.200	3	30.5	4.4
40	0.200	3	24.4	3.6	0.250	3	29.1	3.6
41	0.200	3	24.4	3.6	0.250	3	29.1	3.6
42	0.200	3	24.4	3.6	0.250	3	29.1	3.6
43	0.200	3	30.5	4.4	0.250	3	35.2	4.4
44	0.200	3	30.5	4.4	0.250	3	35.2	4.4
45	0.200	3	30.5	4.4	0.250	3	35.2	4.4
46	0.200	3	30.5	4.4	0.250	3	35.2	4.4
47	0.200	3	24.4	3.6	0.250	3	29.1	3.6
48	0.200	3	24.4	3.6	0.250	3	29.1	3.6
49	0.200	3	24.4	3.6	0.250	3	29.1	3.6
50	0.200	3	30.5	4.4	0.250	3	35.2	4.4
51	0.200	3	30.5	4.4	0.250	3	35.2	4.4
52	0.225	3	32.8	4.4	0.250	3	35.2	4.4
53	0.225	3	32.8	4.4	0.275	3	37.5	4.4
54	0.225	3	26.7	3.6	0.275	3	31.4	3.6
55	0.225	3	26.7	3.6	0.275	3	31.4	3.6
56	0.225	3	26.7	3.6	0.275	3	31.4	3.6
57	0.225	3	32.8	4.4	0.275	3	37.5	4.4
58	0.225	3	32.8	4.4	0.275	3	37.5	4.4
59	0.225	3	32.8	4.4	0.275	3	37.5	4.4
60	0.225	3	32.8	4.4	0.275	3	37.5	4.4
61	0.225	3	26.7	3.6	0.275	3	31.4	3.6
62	0.225	3	26.7	3.6	0.275	3	31.4	3.6
63	0.250	3	29.1	3.6	0.275	3	31.4	3.6
64	0.250	3	35.2	4.4	0.275	3	37.5	4.4
65	0.250	3	35.2	4.4	0.275	3	37.5	4.4
66	0.250	3	35.2	4.4	0.275	3	37.5	4.4
67	0.250	3	35.2	4.4	0.275	3	37.5	4.4
68	0.250	3	29.1	3.6	0.275	3	31.4	3.6
69	0.250	3	29.1	3.6	0.275	3	31.4	3.6
70	0.250	3	29.1	3.6	0.275	3	31.4	3.6
71	0.250	3	35.2	4.4	0.275	3	37.5	4.4
72	0.250	3	35.2	4.4	0.275	3	37.5	4.4
73	0.250	3	35.2	4.4	0.275	3	37.5	4.4
74	0.250	3	35.2	4.4	0.275	3	37.5	4.4
75	0.275	3	31.4	3.6	0.300	3.5	37.7	3.7
76	0.275	3	31.4	3.6	0.300	3.5	37.7	3.7
77	0.275	3	31.4	3.6	0.300	3.5	37.7	3.7
78	0.275	3	37.5	4.4	0.300	3.5	43.8	4.6
79	0.275	3	37.5	4.4	0.300	3.5	43.8	4.6
80	0.275	3	37.5	4.4	0.300	3.5	43.8	4.6
81	0.275	3	37.5	4.4	0.300	3.5	43.8	4.6
82	0.300	3.5	37.7	3.7	0.350	3.5	43.0	3.7
83	0.300	3.5	37.7	3.7	0.350	3.5	43.0	3.7
84	0.300	3.5	37.7	3.7	0.350	3.5	43.0	3.7
85	0.300	3.5	43.8	4.6	0.350	3.5	49.1	4.6
86	0.300	3.5	43.8	4.6	0.350	3.5	49.1	4.6
87	0.300	3.5	43.8	4.6	0.350	3.5	49.1	4.6

TABLE 52B. FOOTING PAD DETAILS (HL-93)

Structure No.	HL-93 Loading					
	Total Thickness (Inches)	Quantity	Plate Thickness (Inches)	Width "G" (N)	Weight (Lbs.- Ft.)	Bolts-Ft.
88	0.500	2	0.250	4	65.6	3.8
89	0.500	2	0.250	4	65.6	3.8
90	0.500	2	0.250	4	65.6	3.8
91	0.500	2	0.250	4	71.7	4.7
92	0.500	2	0.250	4	71.7	4.7
93	0.500	2	0.250	4	71.7	4.7
94	0.500	2	0.250	4	71.7	4.7
95	0.500	2	0.250	4	65.6	3.8
96	0.500	2	0.250	4	65.6	3.8
97	0.500	2	0.250	4	65.6	3.8
98	0.500	2	0.250	4	71.7	4.7
99	0.500	2	0.250	4	71.7	4.7
100	0.500	2	0.250	4	71.7	4.7
101	0.600	3	0.200	6	115.8	5.1
102	0.600	3	0.200	6	109.6	4.2
103	0.600	3	0.200	6	109.6	4.2
104	0.600	3	0.200	6	109.6	4.2
105	0.600	3	0.200	6	115.8	5.1
106	0.600	3	0.200	6	115.8	5.1
107	0.600	3	0.200	6	115.8	5.1
108	0.600	3	0.200	6	115.8	5.1
109	0.600	3	0.200	6	109.6	4.2
110	0.600	3	0.200	6	109.6	4.2
111	0.600	3	0.200	6	109.6	4.2
112	0.600	3	0.200	6	115.8	5.1
113	0.600	3	0.200	6	115.8	5.1
114	0.600	3	0.200	6	115.8	5.1
115	0.600	3	0.200	6	115.8	5.1
116	0.600	3	0.200	6	109.6	4.2
117	0.600	3	0.200	6	109.6	4.2
118	0.600	3	0.200	6	109.6	4.2
119	0.600	3	0.200	6	115.8	5.1
120	0.600	3	0.200	6	115.8	5.1
121	0.600	3	0.200	6	115.8	5.1
122	0.900	4	0.225	6	167.5	5.1
123	0.900	4	0.225	6	161.3	4.2
124	0.900	4	0.225	6	161.3	4.2
125	0.900	4	0.225	6	161.3	4.2
126	0.900	4	0.225	6	167.5	5.1
127	0.900	4	0.225	6	167.5	5.1
128	0.900	4	0.225	6	167.5	5.1
129	0.900	4	0.225	6	167.5	5.1
130	0.900	4	0.225	6	161.3	4.2
131	0.900	4	0.225	6	161.3	4.2
132	0.900	4	0.225	6	161.3	4.2
133	0.900	4	0.225	6	167.5	5.1
134	0.900	4	0.225	6	167.5	5.1
135	0.900	4	0.225	6	167.5	5.1
136	0.900	4	0.225	6	167.5	5.1
137	0.900	4	0.225	6	161.3	4.2
138	0.900	4	0.225	6	161.3	4.2
139	0.900	4	0.225	6	161.3	4.2
140	0.900	4	0.225	6	167.5	5.1
141	0.900	4	0.225	6	167.5	5.1
142	0.900	4	0.225	6	167.5	5.1
143	0.900	4	0.225	6	167.5	5.1

Notes:

1. N=9.625". Use N as a conversion factor. For example, for Structure No. 1, Width "G" is 2 x N, or 19.25".
2. Minimum allowable (unfactored) soil-bearing pressure is 4,000 psf for structures and details shown in this catalog. This applies specifically for width "G" below the footing pad. Other conditions can be accommodated. Contact a Contech representative for more information.
3. The maximum cover for Aluminum Box Culverts with full inverts and footing pads should not exceed 4 feet. Special full invert and footing pad designs or slotted concrete footings can accommodate maximum covers to the limits shown in Tables 48A-48B and 49A-49B.
4. Weight per foot of footing pads includes receiving channels, nuts, bolts, and plates.
5. When the thickness listed is greater than .250", the footing pads will be two or more pieces equaling the composite thickness required.
6. Footing pads must not be overlapped on adjacent structures unless appropriate design modifications are incorporated.

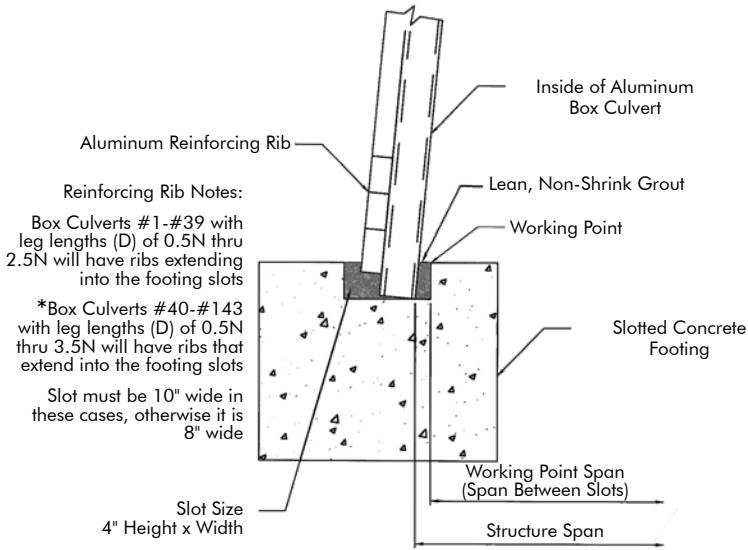

Aluminum Box Culvert Slotted Concrete Footing Option

*See note above. For D dimension see page 68.

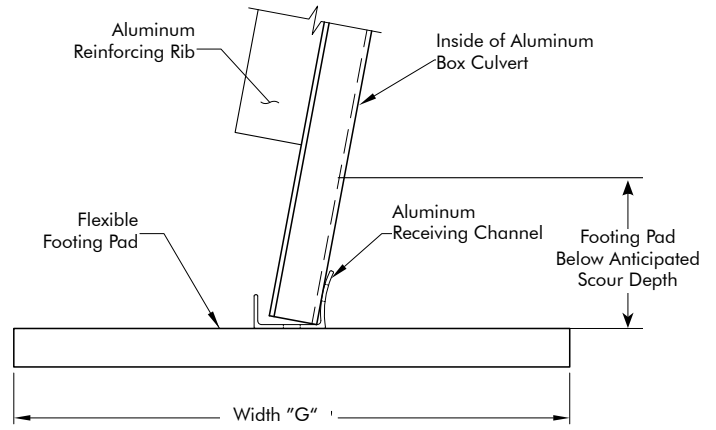

Aluminum Footing Pad Option

(see page 75)

Scour Considerations

In most cases, using a full aluminum invert with toe plate extensions at the inlet and outlet ends will eliminate the potential for scour through the structure. If it is desirable to span the stream crossing, scour should be investigated. The most efficient counter measure, as listed below, should be chosen based on site specific conditions. The selected alternative should be designed by the registered professional engineer for the project.

These counter measures include:

- Rip rap protection
- Concrete paving
- Lower footings below anticipated scour depth
- Bearing foundation on competent rock
- Undercut erodible soils and replace with non-erodible material
- Construction of guide banks including sheet piling
- Implementation of hard armor interlocking blocks where vegetation cannot be established, such as ArmorFlex® or A-Jacks®

Please contact your Contech representative for more details and design information.

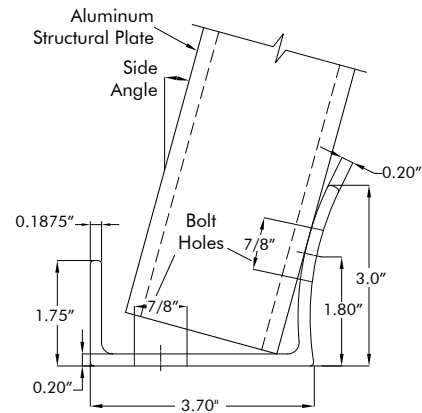

Aluminum Receiving Channel

Weight is equal to 2 lbs per foot per side.

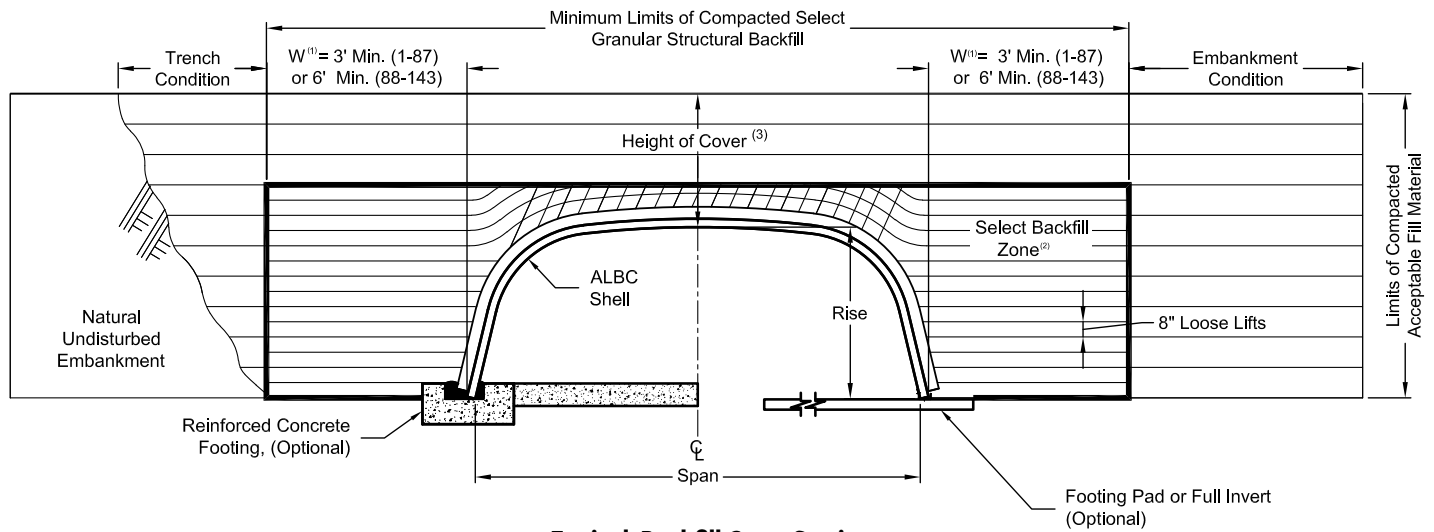

Typical Backfill Cross Section

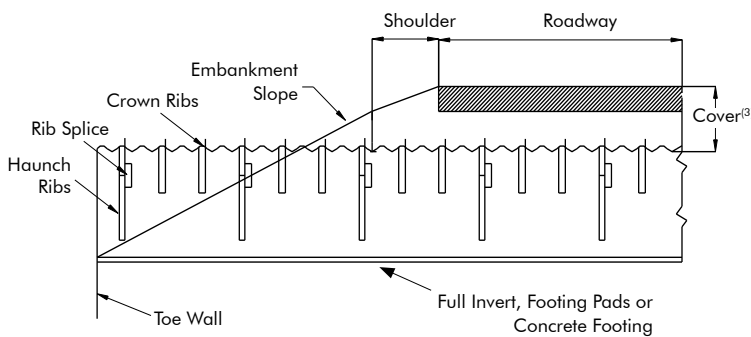

End Treatment With Projecting End Structure

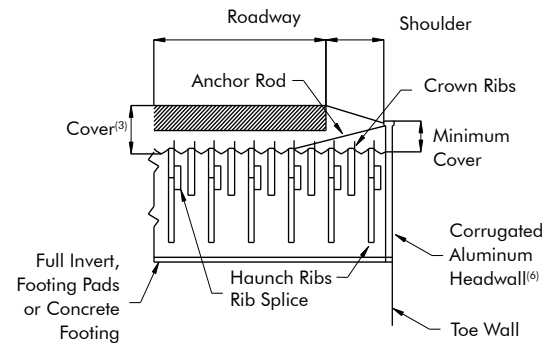

End Treatment With Headwall

Typical End Treatments

Notes:

1. If the select backfill width (W) is less than the required width, a concrete grout material may be required as backfill.
2. Select backfill zone to be well graded granular, A-1, A-2-4, A-2-5, or A-3 Modified for box culverts #1 through #87. For box culverts #88 through #143, A-1, A-2-4, A-2-5 backfill material should be used, per AASHTO M 145, placed in 6" to 8" lifts symmetrically, with no side-to-side differential exceeding 24-inches, on each side compacted to a minimum 90% density per AASHTO T-180. D4 dozer or smaller to operate near and above structure during backfilling to finish grade. Refer to AASHTO Sec. 26 installation specification.
3. Fill in these zones, must be placed in 8" maximum loose lifts and compacted to a minimum 90% density per AASHTO T-180.
4. The addition of temporary soil cover for heavy construction loads is not feasible or permissible for Aluminum Box Culvert structures. By design, these structures are limited in the range of permissible fill heights and live loads.
5. When using a full invert or footing pads, the foundation shall have a minimum of 4,000 psf bearing capacity and include a 6" well graded granular bed. Lower bearing capacities can be accommodated through special design or the use of concrete footings.
6. Standard aluminum headwalls shown are for vertical orientation only.
7. The type and extent of end treatment on the box culvert should be chosen and designed to prevent the loss of backfill due to high flow conditions.
8. Bolt torque requirements - plate lap must be well aligned in a tangent fashion using proper techniques and adequate bolt torque to seat the corrugation. The recommended installation bolt torque for Aluminum Box Culverts is 100-150 ft-lbs.
9. For assembly information, see the manufacturer's detailed assembly drawings and instructions.

Aluminum Box Culvert Project Specification

Scope

This specification covers the manufacture and installation of the aluminum box culvert structure detailed in the plans.

Material

The aluminum box culvert shall consist of plates, ribs, and appurtenant items as shown on the plans and shall conform to the requirements of ASTM B864 and AASHTO M 219. Plate thicknesses, rib spacings, end treatment, and type of invert and foundation shall be as indicated on the plans.

Bolts with suitable nuts shall conform to the requirements of ASTM A307 or ASTM A449 and shall be galvanized in accordance with ASTM A153.

Assembly

The box culvert shall be assembled in accordance with the shop drawings provided by the manufacturer and per the manufacturer's recommendations. Bolts shall be tightened using an applied torque between 100-150 ft-lbs.

Installation

The box culvert shall be installed in accordance with the plans and specifications, the manufacturer's recommendations and the AASHTO Standard Specification for Highway Bridges, Section 26 (Division II).

Bedding

The bedding should be constructed to a uniform line and grade using material outlined in the backfill section. The foundation must be capable of providing a bearing capacity of at least two tons per square foot.

Please reference the project specifications, drawing submittals and Contech's Assembly and Installation Guide for more information.

Backfill

The structure shall be backfilled using clean, well graded granular material that meets the requirements of AASHTO M 145 for soil classifications. A-1, A-2-4, A-2-5, or A-3 Modified for box culverts #1 through #87. For box culverts #88 through #143, A-1, A-2-4, A-2-5 backfill material should be used. Backfill must be placed symmetrically on each side of the structure in 8-inch uncompacted lifts with no side-to-side differential exceeding 24-inches. Each lift shall be compacted to a minimum 90% density per AASHTO T-180.



SUPER-SPAN™ and SUPER-PLATE®

Over 4,000 SUPER-SPANS in Place

Since 1967, more than 4,000 structures have been built on five continents. That makes SUPER-SPAN the most widely accepted, long-span corrugated steel design in the world.

SUPER-SPAN structures with individual spans up to 45 feet are serving as bridges, railroad overpasses, stream enclosures, vehicular tunnels, culverts, and conveyor conduits. Installations have been completed under a wide variety of conditions, including severe weather and unusual construction time constraints.

National Specifications

SUPER-SPAN's popularity has resulted in a national specification written for long-span corrugated metal structures by the American Association of State Highway and Transportation Officials. AASHTO LRFD Bridge Design Specifications (Sec. 12) for Highway Bridges and AASHTO Standard Specifications (Section 12.7) provide for the selection of acceptable combinations of plate thickness, minimum cover requirements, plate radius and other design factors. Material is covered by AASHTO M 167 and ASTM A761. Installation is covered by AASHTO LRFD Bridge Design Specifications (Sec. 12), AASHTO Standard Specification for Highway Bridges (Sec. 12 and 26), LRFD Construction Specifications (Sec. 26) and ASTM A807/A789.

Acceptance

Many state and federal agencies recognize the excellent performance and economy of SUPER-SPAN corrugated structures. In a 1979 memorandum, the chief of FHWA's Bridge Division noted that in the previous 15 years, several hundred Contech SUPER-SPAN Culverts had been erected in the United States and Canada and their performance had been excellent.

In a 1983 report to the Secretary of Transportation, the General Accounting Office stated, "Some innovations, such as using certain long-span culverts rather than building conventional bridges, have substantially lowered bridge costs."

Aluminum Long-Span Structures (SUPER-PLATE)

SUPER-PLATE structures add both longitudinal stiffeners (thrust beams) and circumferential stiffeners (reinforcing ribs) to conventional Aluminum Structural Plate to achieve larger sizes. Clear spans in excess of 35 feet and clear areas over 475 square feet are achievable with SUPER-PLATE. Available shapes include low-profile and high-profile arch and horizontal ellipse (as seen below).

Contact your local Contech representative for additional information about SUPER-SPAN and SUPER-PLATE structures.



High-profile arch SUPER-SPAN in Puerto Rico spanning a wetland and providing a wildlife crossing



Low-Profile Arch

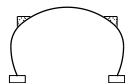

High-Profile Arch

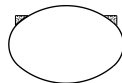

Horizontal Ellipse

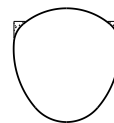

Pear

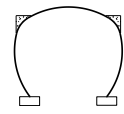

Pear-Arch

Standard Shapes

General design and installation characteristics

As conventional round structures increase in diameter beyond 16 -18 feet, they become more flexible which requires more attention during the installation. It becomes increasingly difficult to both control the shape and to achieve good backfill support. Contech's SUPER-SPAN and SUPER-PLATE help overcome these problems through the use of both special shapes and concrete thrust beams.

SUPER-SPAN/SUPER-PLATE Solves the Problem

The horizontal ellipse, low-profile and high-profile arch shapes are wide-span, reduced-rise structures. They provide large open areas with less rise than comparable circular shapes. Sidewalls have a tighter radius to provide a more rigid pipe wall to compact the backfill against(see Figure 9).

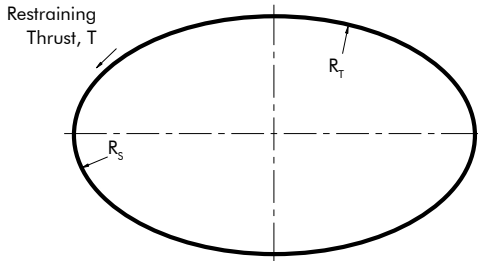

Figure 9

By contrast, Pear and Pear-Arch shapes provide relatively high-rise structures. These shapes orient their sides at the derivable angle to the soil pressures (see Figure 10). Their smaller radius crowns are typically heavy gage to provide the necessary restraint at the top.

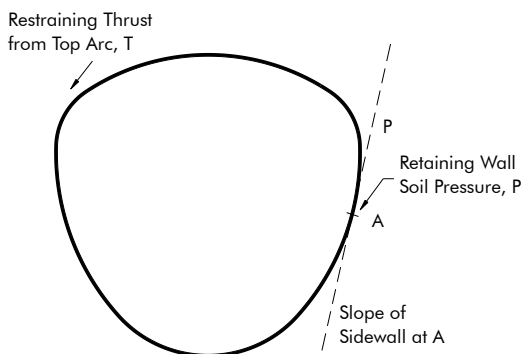
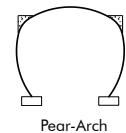
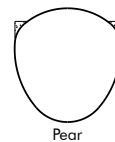
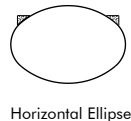
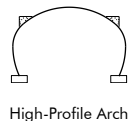

Figure 10



Standard Shapes

The thrust beam is the key element to SUPER-SPAN and SUPER-PLATE success. Besides providing perfect backfill in the important area above the spring line, it acts as a floating footing for the critical large radius top arch of the structure. It fixes the end of the arch, stiffening it and reducing deflection as backfill goes over the top.

The thrust beam also provides a solid vertical surface that is easy to backfill against to obtain excellent compaction*. After installation, the beam effectively controls possible horizontal spreading of the top arch.

Thrust Beam Function

With the shape on the left, it is difficult to obtain adequate compaction of the backfill at the critical 3/4 rise point.

Compare it to the SUPER-SPAN on the right. Excellent compaction* and a high restraining force (R) is readily obtained against the vertical surface of the thrust beam. Force (R) acts on the vertical surface to prevent significant horizontal movement on the pipe wall at the 3/4 rise point under dead and live loads.

*See Backfilling and Backfill material on page 82.

SUPER-SPAN and SUPER-PLATE structures, by means of their shape and thrust beams (which reduce the central angle of the effective top arch to 80 degrees) have added stability against deflection and snap-through buckling. They can be economically designed and installed within recognized AASHTO critical stresses and seam strength limits.



Horizontal reinforcement bars are tied to Contech bent and threaded rods to provide reinforcement for the concrete thrust beam.

Structural Design

TABLE 53
MINIMUM THICKNESS — MINIMUM COVER TABLE (HL-93, H-20, HS-20, H-25, HS-25 LIVE LOAD)

Top Radius R _T Ft.	Gage Thickness (Inches)					
	12 (0.111)	10 (0.140)	8 or 7 (0.170 or 0.188)	5 (0.218)	3 (0.249)	1 (0.280)
15'	2.5'	2.5'	2.5'	2.0'	2.0'	2.0'
15'-17'		3.0'	3.0'	2.5'	2.0'	2.0'
17'-20'			3.0'	2.5'	2.5'	2.5'
20'-23'				3.0'	3.0'	3.0'
23'-25'					4.0'	4.0'

Notes:

1. Designs listed are for steel 6" x 2" corrugation only. For aluminum 9" x 2 1/2" corrugation design, please contact your local Contech representative.
2. Heights of cover for highway live loads given are to top of concrete pavement or bottom of flexible pavement.
3. Minimum covers for E 80 live loads are approximately twice those for HS-20. However, E 80 minimums must be established for individual applications.
4. Minimum covers for construction loads and similar heavy wheel loads must be established for individual applications.
5. The table assumes a granular backfill over the crown of the structure to the full minimum cover depth (height) compacted to not less than a minimum 90% density per AASHTO T-180.
6. Pear and Pear-Arch shape gages are determined on an "as-needed" basis.

Installation Recommendations

A SUPER-SPAN or SUPER-PLATE structure is a composite system combining steel and soil. Maximum fill heights are calculated on the basis of AASHTO LRFD design methods. The thrust in the wall for a long span structure is determined by using twice the value of the top arc radius along with appropriate load factors.

In accordance with AASHTO, buckling and flexibility factors are not calculated. These factors are covered by the minimum thickness/minimum cover table on this page and special geometry limitations spelled out by AASHTO.

Shallow Fill

Minimum designs are shown in Table 53. Shallow cover structures will be at the minimum thickness indicated for installation and to prevent against buckling.

When adding the total live load over the structure, it is necessary to distribute it over an appropriate area of the structure which varies with the fill height.

Special Designs

Structure sizes shown in Tables 54 through 60 are standard shapes. Intermediate or larger sizes are available. These special sizes also are designed in accordance with the AASHTO design method.

Minimum covers shown in Table 53 are based on standard construction. Somewhat lower covers are possible with special measures such as using concrete relieving slabs. Special designs are also available for fill heights exceeding the normal limitations of standard structures. Contact your local Contech representative for additional information on special requirements.

Foundation

The foundation under the structure and sidefill zones must be evaluated by the design engineer to ensure adequate bearing capacity. Differential settlement between the structure and side fill must be minimal.

Hydraulic Design

The most commonly used SUPER-SPAN and SUPER-PLATE hydraulic shapes are the horizontal ellipse, the low-profile arch, and the high-profile arch. Hydraulic data for these shapes are presented in tabular and graphical form in the current edition of the NCSPA CSP Design Manual. Standard procedures are presented in the Hydraulics chapter of the design manual to determine the headwater depth required for a given flow through these structures under both inlet and outlet control conditions.

In addition, the hydraulic design series of publications from FHWA offers guidance regarding hydraulic capacity of these structures.

Installation Precautions

During the installation and prior to the construction of permanent erosion control and end-treatment protection, special precautions may be necessary. The structure must be protected from unbalanced loads and from any structural loads or hydraulic forces that might bend or distort the unsupported ends of the structure. Base channels for arches must be square to the centerline on arch structures. Erosion wash out of previously placed soil support must be prevented to ensure that the structure maintains its load-carrying capacity.

Contech SUPER-SPAN structures have proven both practical and economical to construct in a wide range of applications and conditions. Nevertheless, there are basic rules of installation that must be obeyed to ensure acceptable performance.

Comprehensive installation and inspection standards are furnished with every SUPER-SPAN installation. These documents should be studied thoroughly by the contractor and engineer prior to beginning construction. The following material highlights the key elements involved in the proper construction of a Contech SUPER-SPAN.

Foundation and Bedding

There must be adequate distance between the SUPER-SPAN and questionable in-situ soils. Proper bedding preparation is critical to both structure performance and service life. The bedding should be constructed to a uniform line and grade to avoid distortions that may create undesirable stresses in the structure and/or rapid deterioration of the roadway. It should be free of rock formations, protruding stones, and frozen matter that may cause unequal settlement.

It is recommended that the bedding be a relatively loose granular material that is roughly shaped to fit the bottom of the structure, be a minimum of twice the corrugation depth in thickness and have a maximum particle size of one half the corrugation depth.

It should be noted that the bedding depth can vary based on the amount of cover and the shape of the structure's invert. The bedding should be shaped to match structures with flatter inverts.

Please reference the project specifications, drawing submittals and Contech's Assembly and Installation Guide for more information.

Assembly

Plates can be placed either one at a time or in preassembled units of two or more plates in a ring.

All bolts in a newly hung plate or assembly should be tightened before adding the next unit above it. This should be done only with the plates in proper relation to each other for correct curvature and alignment in the structure. It may be necessary to use cables, props, or jigs to keep the plates in position during tightening.

The structure cross-section must be checked regularly during assembly. Its shape must be symmetrical, with the plates forming smooth, continuous curves. Longitudinal seams should be tight and plate ends should be parallel to each other.

Backfilling

SUPER-SPANS are flexible structures, therefore care is required during the placement and compaction of backfill. An effective system to monitor the structure during the backfilling process must be established.

Select an approved structure backfill material for the zone around the SUPER-SPAN. Establish soil density curves to a minimum 90% density per AASHTO T-180 and determine

proper frequencies and procedures for testing. The equipment used to place and compact fill around and over the structure should be selected based on the quality of the backfill and the shape of the SUPER-SPAN. Such plans should be verified in the initial backfilling stages. Compaction needs to be achieved under the haunches by carefully tamping a granular or select material.

Use only backfilling methods and equipment that obtain specified density without excessive movement or deformation of the structure.

Backfill Material

Contech's specification for backfill material contains the following as listed in the AASHTO Bridge Specification:

1. Granular type soils shall be used as structure backfill (the envelope next to the metal structure). Well graded sand and gravel that is sharp, rough, and angular is preferred.
2. Approved stabilized soil shall be used only under direct supervision of a competent, experienced soils engineer. Plastic or cohesive soils should not be used.
3. The structure backfill material shall conform to one of the following soil classifications from AASHTO Specification M 145, Table 62. Structure backfill shall be placed and compacted to a minimum 90% density per AASHTO T-180.
4. The extent of the select structural backfill outside the maximum span is dependent on the quality of the adjacent embankment, loading and shape of the structure. It may be necessary to excavate native soil at the sides to provide an adequate width needed for compaction. For ordinary installations with a good quality, well-compacted embankment or in situ soil adjacent to the structure backfill, a minimum width of structural backfill six feet beyond the structure is usually required. The engineer must evaluate the in situ conditions to ensure adequate bearing capacity. The structure backfill shall extend to the minimum cover elevation (Table 53—page 81) above the structure.

Monitoring Backfill

Regular monitoring is required during backfilling to ensure a structure with a proper shape and that compaction levels are achieved. A Shape Control Technician will confirm the structure's shape before backfilling, then monitor the shape and verify compaction readings until the backfill reaches the minimum cover level.

Special Requirements

Very large or high structures sometimes call for additional special provisions for shape control during backfilling.

The minimum stiffness requirements for some structures shown in Table 53 on Page 81 may need to be augmented by increased design stiffness or mandatory top loading. Top loading requires the placement of a modest blanket of soil on the crown when backfill is approximately at the springline height.

For specific shape reference, contact Contech Engineering.

SUPER-SPAN™

Galvanized Steel Long Span Structures — 6" x 2" Corrugation Project Specification

General Description

The long span steel structural plate structure, conforming to the dimensions shown on the plans and specifications, shall be installed at the location designated. The design and installation shall conform to AASHTO LRFD Specifications for Highway Bridges, Division I, "Soil-Corrugated Metal Structure Interaction Systems", Section 12, "Long Span Structural Plate Structures", and Division II, Section 26, "Metal Culverts."

Materials

The galvanized steel structural plate shall have 6" x 2" corrugations and shall be of the gage as shown on the plans. The plates shall be manufactured in conformance with AASHTO Specification M 167. Bolts with suitable nuts shall meet the provisions of ASTM A449, Type 1 and ASTM A563, Grade C. The steel anchor bolts shall conform to ASTM A307, Grade A.

Longitudinal Structural Stiffeners (Thrust Beams)

Longitudinal stiffeners shall be located at the radius transition at the ends of the top arc. The thrust beams shall consist of reinforced concrete having a compression strength of 2400 psi, and the reinforcing steel shall conform to ASTM A615, Grade 40, having a minimum yield strength of 40,000 psi. Thrust beams shall be formed and poured conforming to the plan dimensions when the backfill reaches the bottom elevation of the thrust beams.

Design

The long span structure shall be designed in accordance with the latest AASHTO design criteria and shall be required to incorporate the use of continuous longitudinal structural stiffeners (concrete thrust beams).

Structure Assembly

The structure shall be assembled in strict accordance with the manufacturer's instructions and to the design shape shown on the plans. Plates shall be assembled according to plate assembly drawings supplied by the manufacturer.

Structural Backfill Material

A granular type of material shall be used around and over the structure. This select structural backfill material shall conform to one of the following classifications of soil from AASHTO Specification M 145, as modified in the following table for A-1, A-2-4 or A-2-5.

GROUP CLASSIFICATION	A-1		A-2(Modified)	
	A-1-a	A-1-b	A-2-4	A-2-5
Sieve Analysis, Percent Passing:				
No. 10 (2.00 mm)	50 Max.	—	—	—
No. 40 (0.425 mm)	30 Max.	50 Max.	—	—
No. 100 (0.150 mm)	—	—	50 Max.	50 Max.
No. 200 (0.075 mm)	15 Max.	25 Max.	20 Max.	20 Max.
Characteristics of Fraction Passing No. 40 (0.425 mm)				
Liquid Limit	—	—	40 Max.	41 Min.
Plasticity Index	6 Max.	—	10 Max.	10 Max.
Usual Types of Significant Constituent Materials	Stone Fragments Gravel and Sand		Silty or Clayey Gravel and Sand	
* Modified to be more select than M 145.				

Additional Requirements

- Materials must be dense graded (open graded or gap graded materials are not allowed).
- Fine beach sands, windblown sands, and stream deposited sands all of which exhibit fine, rounded particles and typically are classified by AASHTO M 145 as A-3 materials are not allowed.
- On site mixing or blending to achieve specified gradation is not allowed.

Maximum particle size shall not exceed 3 inches. For the A-2 materials, moisture content must be between -3% and +2% optimum as defined by AASHTO T 180. All soil classifications are limited to the following height of cover limits and structure shape applications:

- A-1-a material is suitable for all long span shapes, sizes and fill heights.
- A-1-b material is suitable only for use with high profile arch and pear shape structures to a 12' maximum fill height and for use with elliptical and low profile arch structures to a 20' maximum fill height.
- A-2-4 and A-2-5 materials are restricted to maximum heights of cover of 12'. These materials are not allowed for use with pear, pear arch or high profile arches with more than 30 Pi in the side arc.

Other backfill materials which provide equivalent structural properties, longterm, in the environmental conditions expected (saturation, freeze-thaw, etc.) may be used. Such materials shall be approved only after thorough investigation and testing by a soils engineer familiar with the requirements for structural backfill of long span structures.

Backfill Envelope Limits

The backfill envelope limits are as detailed on the plans.

Backfill Placement

Before backfilling, the erected structure shall meet the tolerance and symmetry requirements of AASHTO and the manufacturer.

Approved backfill material shall be placed in horizontal, uniform layers not exceeding 8" in thickness, before compaction, and shall be brought up uniformly on both sides of the structure. Each layer of backfill shall be compacted to a relative density of not less than 90%, modified proctor per AASHTO T 180. Field density tests of compacted backfill will be made at regular intervals during backfill.

Long span structures, due to their size and shape, are sensitive to the types and weights of equipment used to place and compact the select backfill material. This is especially critical in the areas immediately adjacent to and above the structure. Therefore, equipment types will be restricted in those critical zones. Compaction equipment or methods that produce horizontal or vertical earth pressures which cause excessive distortion or damage to structures shall not be used.

Contractors should plan to have a D4 (approximately 20,000 lbs.) or similar weight tracked dozer to place and grade backfill immediately alongside and radially above the structure until minimum cover level is reached. Lightweight vibratory plate or roller type compaction equipment must be used to compact the backfill in these zones. Use of heavier equipment and/or rubber tired equipment such as scrapers, graders, and front end loaders will likely be prohibited inside the select fill envelope zone until appropriate minimum cover height has been obtained.

Shape Control Monitoring

Contech shall provide a Shape Control Technician who is a qualified representative of a professional soils engineering firm, or other qualified organization, to ensure a properly shaped structure. The Shape Control Technician shall take initial measurements of the erected structure before backfilling, observe all backfill materials and their placement, and record compaction densities. The Technician shall record all density readings and ensure they meet the requirements of the plans and specifications. However, in no case shall the relative densities be less than 90% per AASHTO T 180. The Shape Control Technician shall monitor the structure shape during the placement of structural backfill to the minimum cover height over the structure. **No structural backfill shall be placed without the Shape Control Technician on site.**

The Shape Control Technician Shall:

- Monitor the structure's shape throughout the backfilling operation and report shape change rates to the contractor.
- Contact the Contech representative immediately if there are problems in meeting the established tolerances.
- Have full authority to stop backfill work if necessary.

Preconstruction Meeting

Prior to construction, a meeting will be held to review the construction procedures. A qualified representative of the manufacturer of the structure will be present to discuss methods and responsibility for shape monitoring and control, backfill material selection, testing and placement, and compaction methods and testing. A representative of the Engineer, Prime Contractor, and any involved sub-contractors must be present.

Alternate Structures

The Contractor may furnish an alternate structure to the long span shown on the plans and these specifications but the following conditions must be met:

1. The structure must be designed using the AASHTO Long Span criteria and these plans and specifications. Steel structural plate shall conform to the requirements of AASHTO M 167.
2. The corrugated metal plate thickness specified is considered the minimum acceptable for the structure(s) on this project based on structural and durability requirements. Any other structure, regardless of "special features", must be of the same thickness or greater.
3. "Special Features", such as hot rolled structural steel ribs, shall be hot-dip galvanized after fabrication per ASTM A123. Ribs shall be placed across the top 180°, i.e., to the springline of all structures. Maximum rib spacing shall be two (2) feet. Ribs shall be placed over the same length of structure that the thrust beams would apply. No allowance for composite action between the rib and plate will be allowed. The combined moment of inertia of both plate and rib must satisfy the normal flexibility factor as shown in AASHTO Section 12.8.3.5. The span in the formula for the flexibility factor shall be replaced by twice the top arc radius.
4. Alternate structures meeting the above criteria will only be considered for use if pre-approved in writing by the Engineer prior to the bid date. To qualify for pre-approval, an alternate submittal package must be submitted to the Engineer a minimum of 15 days prior to the bid date.
5. The material supplier shall be a qualified manufacturer of steel structural plate and long span structures with a minimum of 50 successful installations. The foundation, structural backfill and end treatment shall be as required herein and detailed on the plans.

Contact your local Contech representative for additional information about SUPER-SPAN structures.

SUPER-PLATE®

Aluminum Long Span Structures 9" x 2-1/2" Corrugation Project Specification

General Description

The long span aluminum structural plate structure, conforming to the dimensions shown on the plans and specifications, shall be installed at the location designated. The design and installation shall conform to AASHTO LRFD Specifications for Highway Bridges, Division I, "Soil-Corrugated Metal Structure Interaction Systems", Section 12, "Long Span Structural Plate Structures", and Division II, Section 26, "Metal Culverts."

Materials

The aluminum structural plate shall have 9" x 2-1/2" corrugations and shall be of the gage as shown on the plans. The plates shall be manufactured in conformance with AASHTO Specification M 219 and ASTM B209. Bolts with suitable nuts shall meet the provisions of ASTM A307/A449 and ASTM A563, and shall be galvanized in accordance with the requirements of ASTM A153 or B695. Steel anchor bolts shall conform to ASTM A307.

Required stiffening ribs for the crown portion shall be extruded bulb angles produced from 6061-T6 alloy providing a minimum 35 ksi yield strength.

Long Span Special Features

Aluminum Long Span Structures will require transverse stiffening ribs as well as longitudinal stiffeners.

Transverse Stiffeners

Transverse stiffeners will be bolted to the crown portion of the structure on 1 N (9.625") maximum circumferential centers. Their size and longitudinal spacing must adequately stiffen the top portion of the crown over a minimum 55 degree arc.

Longitudinal Structural Stiffeners (Thrust Beams)

Longitudinal stiffeners shall be located at the radius transition at the ends of the top arc. The thrust beams shall consist of reinforced concrete having a compression strength of 2400 psi, and the reinforcing steel shall conform to ASTM A615, Grade 40, having a minimum yield strength of 40,000 psi. Black reinforcing steel shall in no instance come in contact with the Aluminum Structural Plate. Thrust beams shall be formed and poured conforming to the plan dimensions when the backfill reaches the bottom elevation of the thrust beams.

Design

The long span structure shall be designed in accordance with the latest AASHTO design criteria and shall be required to incorporate the use of continuous longitudinal structural stiffeners (concrete thrust beams). The material supplier shall be a qualified manufacturer of aluminum structural plate and long span structures with a minimum of 50 successful installations. The foundation, structural backfill, and end treatment shall be as required herein and detailed on the plans.

Structure Assembly

The structure shall be assembled in strict accordance with the manufacturer's instructions and to the design shape shown on the plans. Plates shall be assembled according to plate assembly drawings supplied by the manufacturer.

Structural Backfill

Material

A granular type of material shall be used around and over the structure. This select structural backfill material shall conform to one of the following classifications of soil from AASHTO Specification M 145, as modified in the following table for A-1, A-2-4 or A-2-5.



SUPER-SPAN horizontal ellipse with reinforced concrete headwall for a mining application.

TABLE 66. - AASHTO M 145

GROUP CLASSIFICATION	A-1		A-2 (Modified)	
	A-1-a	A-1-b	A-2-4	A-2-5
Sieve Analysis, Percent Passing:				
No. 10 (2.00 mm)	50 Max.	—	—	—
No. 40 (0.425 mm)	30 Max.	50 Max.	—	—
No. 100 (0.150 mm)	—	—	50 Max.	50 Max.
No. 200 (0.075 mm)	15 Max.	25 Max.	20 Max.	20 Max.
Characteristics of Fraction Passing No. 40 (0.425 mm)				
Liquid Limit	—		40 Max.	41 Min.
Plasticity Index	6 Max.		10 Max.	10 Max.
Usual Types of Significant Constituent Materials	Stone Fragments Gravel and Sand		Silty or Clayey Gravel and Sand	

* Modified to be more select than M 145.

Additional Requirements

1. Materials must be dense graded (open graded or gap graded materials are not allowed).
2. Fine beach sands, windblown sands, and stream deposited sands, all of which exhibit fine, rounded particles and typically are classified by AASHTO M 145 as A-3 materials, are not allowed.
3. On site mixing or blending to achieve specified gradation is not allowed.

Maximum particle size shall not exceed 3 inches. For the A-2 materials, moisture content must be between -3% and +2% optimum as defined by AASHTO specification T 180. All soil classifications are limited to the following height of cover limits and structure shape applications:

- A-1-a material is suitable for all long span shapes, sizes and fill heights.
- A-1-b material is suitable only for use with high profile arch structures to a 12' maximum fill height and for use with elliptical and low profile arch structures to a 20' maximum fill height.
- A-2-4 and A-2-5 materials are restricted to maximum heights of cover of 12'.

Other backfill materials, which provide equivalent structural properties, long-term, in the environmental conditions expected (saturation, freeze-thaw, etc.), may be used. Such materials shall be approved only after thorough investigation and testing by a soils engineer familiar with the requirements for structural backfill of long span structures.

Backfill Envelope Limits

The backfill envelope limits are as detailed on the plans.

Backfill Placement

Before backfilling, the erected structure shall meet the tolerance and symmetry requirements of AASHTO and the manufacturer.

Approved backfill material shall be placed in horizontal, uniform layers not exceeding 8" in thickness, before compaction, and shall be brought up uniformly on both sides of the structure. Each layer of backfill shall be compacted to a minimum 90% density per AASHTO T-180. Field density tests of compacted backfill will be made at regular intervals during backfill.

Long span structures, due to their size and shape, are sensitive to the types and weights of equipment used to place and compact the select backfill material. This is especially critical in the areas immediately adjacent to and above the structure. Therefore, equipment types will be restricted in those critical zones. Compaction equipment or methods that produce horizontal or vertical earth pressures which cause excessive distortion or damage to structures shall not be used.

Contractors should plan to have a D4 (approximately 20,000 lbs.) or similar weight tracked dozer to place and grade backfill immediately alongside and radially above the structure until minimum cover level is reached. Lightweight vibratory plate or roller type compaction equipment must be used to compact the backfill in these zones. Use of heavier equipment and/or rubber tired equipment such as scrapers, graders, and front end loaders will likely be prohibited inside the select fill envelope zone until appropriate minimum cover height has been obtained.

Shape Control Monitoring

The material supplier or the manufacturer shall provide a Shape Control Technician who is a qualified representative of a professional soils engineering firm, or other qualified organization, to ensure properly shaped structure. The Shape Control Technician shall take initial measurements of the erected structure before backfilling, observe all backfill materials and their placement, and record compaction densities. The Technician shall record all density readings and ensure they meet the requirements of the plans and specifications. However, in no case shall the relative density be less than a minimum 90% density per AASHTO T-180. The Shape Control Technician shall monitor the structure shape during the placement of structural backfill to the minimum cover height over the structure. **No structural backfill shall be placed without the Shape Control Technician on site.**

The Shape Control Technician shall:

- Monitor the structure's shape throughout the backfilling operation and report shape change rates to the contractor.
- Contact the material supplier or the manufacturer immediately if there are problems in meeting the established tolerances.
- Have full authority to stop backfill work if necessary.

Preconstruction Meeting

Prior to construction, a meeting will be held to review the construction procedures. A qualified representative of the manufacturer of the structure will be present to discuss methods and responsibility for shape monitoring and control, backfill material selection, testing and placement, and compaction methods and testing. A representative of the Engineer, Prime Contractor and any involved sub-contractors must be present.

Alternate Structures

The Contractor may furnish an alternate structure to the long span shown on the plans and these specifications but the following conditions must be met:

1. The structure must be designed using the AASHTO Long Span criteria and these plans and specifications. Aluminum alloy structural plate shall conform to the requirements of AASHTO M 219.
2. The corrugated metal plate thickness specified is considered the minimum acceptable for the structure(s) on this project, based on structural and durability requirements. Any other structure, regardless of "special features", must be of the same thickness or greater.
3. When longitudinal reinforcements are not used, the "Special Features", such as aluminum structural ribs, shall be aluminum alloy 6061-T6. Ribs shall be placed over the same length of structure that the thrust beams would apply.
4. Alternate structures meeting the above criteria will only be considered for use if pre-approved in writing by the Engineer prior to the bid date. To qualify for pre-approval, an alternate submittal package must be submitted to the Engineer a minimum of 15 days prior to the bid date.

Contact your local Contech representative for additional information about SUPER-PLATE structures.



SUPER-SPAN Single Radius Arch with Keystone Headwalls for a Residential Development.

BridgeCor® Deep Corrugation Expands Structural Plate

Corrugated steel structural plate has a long history dating back to 1931. It is a proven buried bridge standard due to its strength, durability, and economy. BridgeCor, a deep corrugation pattern, provides designers of bridge systems the option to use structural plate bridges with wider spans and taller rises. BridgeCor is manufactured in a 15" X 5.5" corrugation pattern and Contech has improved on the manufacturing process to provide a three corrugation plate.

BridgeCor structures are made from sturdy, heavy gage, corrugated steel plates that are pre-formed to various shapes and sizes, then galvanized for long-term protection and performance. The plates are delivered to the job site and bolted together to form a BridgeCor structure specifically chosen for the project.

BridgeCor is available in Round, Single and 2-Radius Arches and Box Culverts - all in a wide range of sizes. Custom shapes, such as Ellipses and 3-Radius Arches, are also an option. BridgeCor and its associated shapes are accepted by AASHTO and have been installed around the world.

Superior Durability

BridgeCor is similar to MULTI-PLATE and is manufactured from heavy gage steel using an industry standard of 3 oz. per square foot galvanized coating. The long history of structural plate installations have shown these designs can provide a service life of 75 years or longer.

When selecting the proper material for an application, designers need to evaluate the soil side of the structure along with the corrosive and abrasive action due to the flow at the invert of the structure. The use of structural plate gives designers more structure shape options to help minimize the impact of abrasion on the invert of the structure.

High Load-Carrying Capacity

As a steel-soil interaction system, BridgeCor is designed to carry high combined live and dead loads. High traffic loads and deep cover applications are a structural plate specialty.

More Efficient Installation Process

Prefabricated plates are assembled in the field, translating into finished construction in days instead of weeks as with most cast-in-place concrete structures.

Versatility

BridgeCor structures offer a wide variety of shape and size options, which may provide the most cost effective solution to the site requirements.

Description of Plates

BridgeCor plates are field assembled into round, arch, and box culvert structures. Corrugations of 15-inch pitch and 5.5-inch depth are perpendicular to the length of each plate.

Thickness. Standard specified thickness of the galvanized plates vary from 0.170 (8 gage) to 0.380 inches (3/8").

Lengths. BridgeCor plates are furnished in either 2.50 foot net lengths or 3.75 foot net lengths. Please refer to the assembly drawings for the specific plate sizes. Actual length of a square-ended structure is three inches longer than its net length because a 1 1/2-inch lip protrudes beyond each end of every plate for lapping purposes.

Widths. Standard plates come in multiples of 16 inches ($S=16$ inches or $5 * \text{Pi}$) and are fabricated in eleven net covering widths. The "S" nomenclature translates circumference directly into nominal diameter in inches (for additional detail see Table 67).

Bolt holes. BridgeCor plates are punched with 1 inch holes for 8 gage through 1 gage plates to accommodate a 3/4 inch bolt. Circumferential holes are punched on 16 inch (1 S) centers. All BridgeCor requires a staggered longitudinal seam. These seams have a three-hole bolt pattern in the crest and valley of the corrugations along the length of structure to help provide additional seam strength. For heavier plate structures (0.318" and 0.380"), the holes are punched to 1.125 inch diameter along the seams to accommodate a 7/8 inch bolt. Bolt lengths will vary depending on the location of the bolt and the number of plates in a given location.

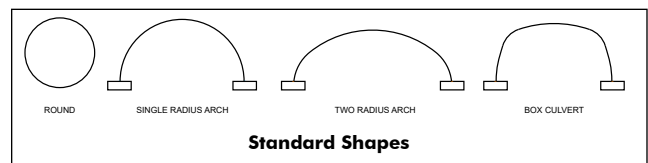

Standard Plate Detail

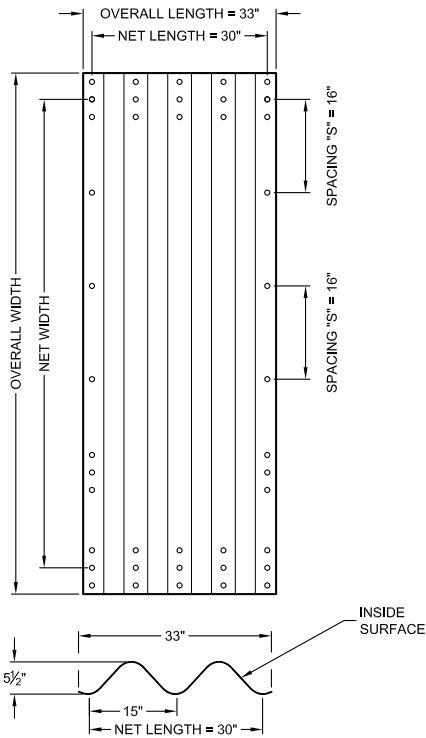

15" x 5.5" Corrugation, 30" Long Detail

Notes:

1. The plate length is subject to manufacturing capabilities.
2. All bolts are per ASTM A449 (with suitable nuts) and are 3/4" diameter for all thicknesses except 5/16" and 3/8", which are 7/8" diameter.

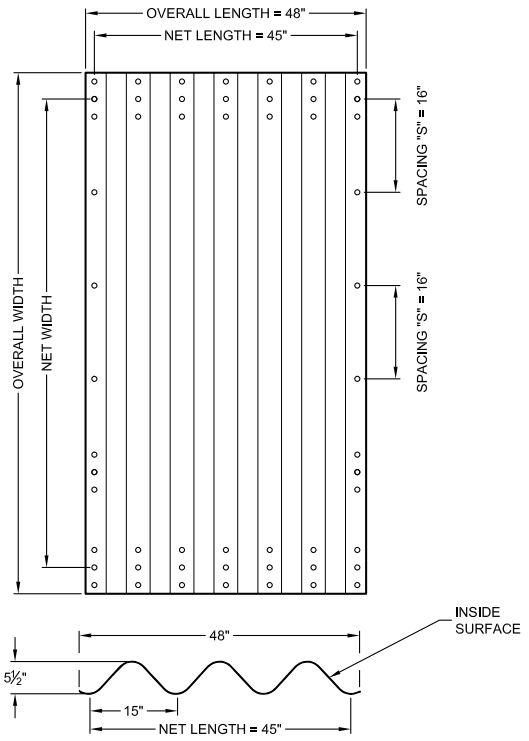

15" x 5.5" Corrugation, 45" Long Detail

TABLE 68 A. APPROXIMATE WEIGHT OF BRIDGECOR SECTIONS (45" PLATES)

Plate Width S	Overall Width (Feet)	8 (0.170)	7 (0.188)	5 (0.218)	3 (0.249)	1 (0.280)
4 S	6.1	219	242	280	321	361
5 S	7.4	267	295	342	391	440
6 S	8.8	315	348	404	461	519
7 S	10.1	363	401	465	531	598
8 S	11.4	411	454	527	602	677
9 S	12.8	459	507	588	672	756

TABLE 67. DETAILS OF UNCURVED BRIDGECOR SECTIONS

Nominal	Net Width (Inches)	Overall Width (Inches)	Spaces (16 inches)	Number of Circumferential Bolt Holes
4 S	64	73	4	5
5 S	80	89	5	6
6 S	96	105	6	7
7 S	112	121	7	8
8 S	128	137	8	9
9 S	144	153	9	10
10 S	160	169	10	11
11 S	176	185	11	12
12 S	192	201	12	13
13 S	208	217	13	14
14 S	224	233	14	15

For BridgeCor, S = 16 inches.

TABLE 68 B. APPROXIMATE WEIGHT OF BRIDGECOR SECTIONS (30" PLATES)

Plate Width S	Overall Width (Feet)	8 (0.170)	7 (0.188)	5 (0.218)	3 (0.249)	1 (0.280)	5/16* (0.318)	3/8* (0.380)
4 S	6.1	152	165	192	218	250	285	339
5 S	7.4	185	201	234	267	305	347	414
6 S	8.8	218	248	276	315	360	409	489
7 S	10.1	251	286	318	362	414	471	563
8 S	11.4	284	323	360	410	469	534	638
9 S	12.8	317	361	402	458	524	596	712
10 S	14.1	350	381	444	506	578	637	n/a
11 S	15.4	384	436	486	554	633	704	n/a
12 S	16.8	417	474	528	601	688	765	n/a
13 S	18.1	450	512	570	649	742	826	n/a
14 S	19.4	483	549	612	697	797	878	n/a

1. Weights are based on a zinc coating of 3 oz./sq. ft. of double-exposed surface.
 2. All weights are subject to manufacturing tolerances.
 3. Specified thickness is a nominal galvanized thickness. Reference AASHTO M 167.
 4. S = 16 inches
- * For 5/16" or 3/8" the net length is 2.5' (30")

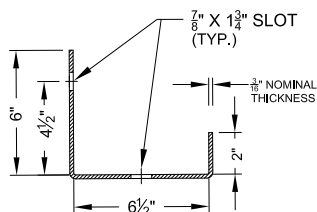

Unbalanced Channel Cross Section
Note: Weight is 10 lbs per foot per side.

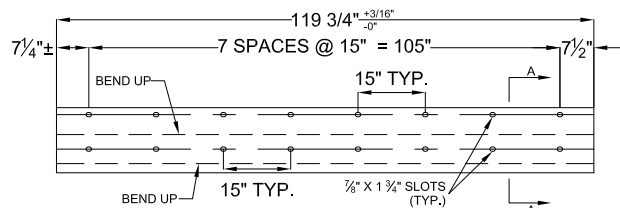

Unbalanced Channel for BridgeCor® Arch "Unfolded View"

BridgeCor® Galvanized Steel Project Specification

Scope: This specification covers the manufacture and installation of the galvanized steel BridgeCor structure as detailed in the plans.

I - GENERAL

1.0 STANDARDS AND DEFINITIONS

- 1.1 STANDARDS - All standards refer to latest edition unless otherwise noted.
 - 1.1.1 ASTM A761 "Corrugated Steel Structural Plate, Zinc Coated for Field-Bolted Pipe, Pipe-Arches and Arches" (AASHTO Designation M 167).
 - 1.1.2 AASHTO LRFD Bridge Design Specification for Highway Bridges - Section 12.8.9.
 - 1.1.3 AASHTO LRFD Bridge Construction Specification for Highway Bridges - Section 26.
- 1.2 DEFINITIONS
 - 1.2.1 Owner - In these specifications the word "Owner" shall mean the site owner or the purchaser.
 - 1.2.2 Engineer - In these specifications the word "Engineer" shall mean the Engineer of Record or Owner's designated engineering representative.
 - 1.2.3 Manufacturer - In these specifications the word "Manufacturer" shall mean Contech Engineered Solutions LLC 800-338-1122.
 - 1.2.4 Contractor - In these specifications the word "Contractor" shall mean the firm or corporation undertaking the execution of any installation work under the terms of these specifications.
 - 1.2.5 Approved - In these specifications the word "approved" shall refer to the approval of the Engineer or their designated representative.
 - 1.2.6 As Directed - In these specifications the words "as directed" shall refer to the directions to the Contractor from the Owner or his designated representative.

2.0 GENERAL CONDITIONS

- 2.1 The Contractor shall furnish all labor, material and equipment and perform all work and services except those set out and furnished by the Owner, necessary to complete in a satisfactory manner the site preparation, excavation, filling, compaction, grading as shown on the plans and as described therein. This work shall consist of all mobilization clearing and grading, grubbing, stripping, removal of existing material unless otherwise stated, preparation of the land to be filled, filling of the land, spreading and compaction of the fill, and all subsidiary work necessary to complete the grading of the cut and fill areas to conform with the lines, grades, slopes, and specifications. This work is to be accomplished under the observation of the Owner or his designated representative.
- 2.2 Prior to bidding the work, the Contractor shall examine, investigate and inspect the construction site as to the nature and location of the work, and the general and local conditions at the construction site, including without limitation, the character of surface or subsurface conditions and obstacles to be encountered on and around the construction site and shall make such additional investigation as he may deem necessary for the planning and proper execution of the work.

If conditions other than those indicated are discovered by the Contractor, the Owner shall be notified immediately. The material which the Contractor believes to be a changed condition shall not be disturbed so that the owner can investigate the condition.
- 2.3 The construction shall be performed under the direction of the Engineer.
- 2.4 All aspects of the structure design and site layout including foundations, backfill, end treatments and necessary scour consideration shall be performed by the Engineer.

Any installation guidance provided herein shall be endorsed by the Engineer or superseded by the Engineer's plans and specifications.

II - Contech BridgeCor

Round, Single Radius Arch, 2-Radius Arch, 3-Radius Arch, Ellipse or Box

1.0 GENERAL

- 1.1 Manufacturer shall fabricate the selected shape as shown on the plans. Fabrication shall conform to the requirements of ASTM A761 and shall consist of plates, fasteners, and appurtenant items.

Plate thickness, end treatment and type of invert and foundation shall be as indicated on the plans. All manufacturing processes including corrugating, punching, curving and required galvanizing shall be performed within the United States of America.

- 1.2 The contractor shall verify all field dimensions and conditions prior to ordering materials.

2.0 DIMENSIONS

- 2.1 The proposed structure shall be a Contech BridgeCor with the following dimensions, as an example:

Span: 49'-11"; Rise: 22'-10"; Gage: 1(0.280); "S": 57

- 2.2 All plan dimensions on the contract drawings are measured in a true horizontal plan unless otherwise noted.

3.0 ASSEMBLY AND INSTALLATION

- 3.1 Bolts with suitable nuts shall conform to the requirements of ASTM A449. The Contech BridgeCor [insert shape] shall be assembled in accordance with the plate layout drawings provided by the manufacturer and per the manufacturer's recommendations.

Bolts shall be tightened using an applied torque of between 150 and 300 ft.-lbs.

- 3.2 The [insert structure shape] shall be installed in accordance with the plans and specifications, the manufacturer's recommendations, and AASHTO LRFD Bridge Construction Specification for Highway Bridges - Section 26.
- 3.3 Trench excavation shall be made in embankment material that is structurally adequate. The trench width shall be shown on the plans. Poor quality in situ embankment material must be removed and replaced with suitable backfill as directed by the Engineer.
- 3.4 The bedding should be constructed to a uniform line and grade to avoid distortions that may create undesirable stresses in the structure and/or rapid deterioration of the roadway. It should be free of rock formations, protruding stones, and frozen matter that may cause unequal settlement.

It is recommended that the bedding be a relatively loose granular material that is roughly shaped to fit the bottom of the structure, be a minimum of twice the corrugation depth in thickness and have a maximum particle size of one half the corrugation depth. It should be noted that the bedding depth can vary based on the amount of cover and the shape of the structure's invert. The bedding should be shaped to match structures with flatter inverts.

- 3.5 Adequate soil bearing capacity or strength shall be provided to the Engineer. Foundation details shall be provided by the Engineer.
- 3.6 The structure shall be assembled in accordance with the Manufacturer's instructions. All plates shall be unloaded and handled with reasonable care. Plates shall not be rolled or dragged over gravel rock and shall be prevented from striking rock or other hard objects during placement in trench or on bedding.

When assembled on a cast in place spread footing, the structure shall be assembled in the footing starting at the upstream end. When assembled on a full invert, the invert shall be placed starting at the downstream end. The structure shell shall be assembled on the invert starting at the inlet end. Circumferential seams shall be installed with the plate laps shingled downstream as viewed from the inside of the structure.

The structure shall be backfilled using clean well graded granular material that meets the requirements of a finite element analysis, which may concur with AASHTO M 145 for soil classifications A-1, A-2-4, A-2-5 or A-3 according to Table 69.

Backfill must be placed symmetrically on each side of the structure in 8 inch loose lifts, with no side-to-side differential exceeding 24-inches. Each lift shall be compacted to a minimum 90% density per AASHTO T-180.

- 3.7 Construction loads that exceed highway load limits are not allowed to cross the structure without approval from the Engineer.

Normal highway traffic is not allowed to cross the structure until the structure has been backfilled and paved. If the road is unpaved, cover allowance to accommodate rutting shall be as directed by the Engineer.

Installation Recommendations

A successful installation is dependent on these six critical components being followed:

1. Proper foundation.
2. Proper structure assembly.
3. Use of select structural backfill.
4. 8" maximum thick lifts of backfill evenly placed on both sides of the structure.
5. Verification of backfill compaction.
6. Minimum cover over the structure.

Required Elements

Satisfactory site preparation, trench excavation and bedding and backfill operations are essential to develop the strength of any flexible conduit. In order to obtain proper strength while preventing settlement, it is necessary that the soil envelope around the structure be of good quality, well graded granular material, properly placed, and carefully compacted.

A qualified Engineer should be engaged to design a proper foundation, adequate bedding, and backfill material.

Trench Excavation

If the adjacent embankment material is structurally adequate per the Engineer of Record, the trench requires a bottom clear width of the structure's span plus sufficient room for proper compaction equipment.

Bedding

The bedding should be constructed to a uniform line and grade to avoid distortions that may create undesirable stresses in the structure and/or rapid deterioration of the roadway. It should be free of rock formations, protruding stones, and frozen matter that may cause unequal

settlement.

It is recommended that the bedding be a relatively loose granular material that is roughly shaped to fit the bottom of the structure, be a minimum of twice the corrugation depth in thickness and have a maximum particle size of one half the corrugation depth.

It should be noted that the bedding depth can vary based on the amount of cover and the shape of the structure's invert. The bedding should be shaped to match structures with flatter inverts.

Please reference the project specifications, drawing submittals and Contech's Assembly and Installation Guide for more information.

Bolting

If the plates are well aligned, the torque applied with a power wrench need not be excessive. Bolts should be torqued initially to a minimum 150 foot pounds and a maximum 300 foot pounds. A good plate fit is far better than high torque.

Complete detailed assembly instructions and drawings are provided with each structure.

Erosion Control

During installation and prior to the construction of permanent erosion control and end treatment protection, special precautions may be necessary. The structure must be protected from unbalanced loads and from any structural loads or hydraulic forces that may bend or distort the unsupported ends of the structure. Erosion or wash out of previously placed soil support must be prevented to ensure that the structure maintains its load capacity.



BridgeCor with a welded wire wall system for a county road stream crossing.

Backfill Material

Satisfactory backfill material, proper placement and compaction are key factors in obtaining maximum strength and stability.

The backfill material should be free of rocks, frozen lumps, and foreign material that can cause hard spots or decompose to create voids. Backfill material should be well graded granular material that meets the requirements of a finite element analysis, which may concur with AASHTO M 145 for soil classifications A-1, A-2-4, A-2-5, or A-3 in Table 69. Backfill must be placed symmetrically on each side of the structure in eight-inch loose lifts, with no side-to-side differential exceeding 24-inch. Each lift shall be compacted to a minimum 90% density per AASHTO T-180.

A high percentage of silt or fine sand in the native soils suggests the need for a well graded granular backfill material to prevent soil migration.

Contractors should plan to have a maximum 20,000 lbs. tracked dozer to place and grade backfill immediately alongside and radially above the structure until minimum cover level is reached. Lightweight vibratory plate or roller type compaction equipment must be used to compact the backfill in these zones. Use of heavier equipment and/or rubber tired equipment such as scrapers, graders, and front end loaders will likely be prohibited inside the select fill envelope zone until appropriate minimum cover height has been obtained.

The Engineer and Contractor are cautioned that the minimum cover may need to be increased to handle temporary construction vehicle loads (heavier than the design highway load).

For more information, refer to ASTM A807 and AASHTO LRFD Bridge Construction Specifications for Highway Bridges Div. II – Construction Section 26.



Each lift shall be compacted to a minimum 90% density per AASHTO T-180.

TABLE 69. STRUCTURAL PLATE BACKFILL GROUP CLASSIFICATION, REFERENCE AASHTO M 145

Group Classification	A-1-a	A-1-b	A-2-4	A-2-5	A-3
Sieve Analysis Percent Passing					
No. 10 (2.000 mm)	50 max	----	----	----	----
No. 40 (0.425 mm)	30 max	50 max	----	----	51 max*
No. 200 (0.075 mm)	15 max	25 max	35 max	35 max	10 max
Atterberg Limits for Fraction Passing No. 40 (0.425 mm)					
Liquid Limits	----	----	40 max	41 min	----
Plasticity Index	6 max	6 max	10 max	10 max	Non-Plastic
Usual Materials	Stone Fragment, Gravel and Sand		Silty or Clayey Gravel and Sand		Coarse Sand
Most Probable Comparable Soil Groups In The Unified Soil Classification System Reference ASTM D2487	GW, GP	SW, SP, GM, SM	GM, SM	GM, SM	SP

* Modified from M 145. Material shall be a 3" maximum particle size. Fine Beach Sands, Windblown Sands, Stream Deposited Sands, etc., Exhibiting Fine, Rounded Particles And Typically Classified By AASHTO M 145 as A-3 Materials Should Not Be Used.



BridgeCor Tunnel Installation



BridgeCor Box Culvert Assembly



BridgeCor Assembly

BridgeCor Reline of Old Stone Arch Bridge



BridgeCor® - External Rib System Deep Corrugation Expands Structural Plate

Contech innovations continue to take structural plate buried bridge systems to the next level with the new BridgeCor External Rib System. The BridgeCor External Rib System optimizes structure designs, reduces the amount of material required, increases spans up to 80', and maximizes the overall structure stability.

Features and Benefits

- Spans between 40' - 80'
- Complete bridge system – Rapid installation
- Material optimization for steel and backfill savings
- Cost-savings vs. conventional bridge structures
- Suitable for new construction, retrofit, deep cover and rehabilitation applications
- Ideal for DOTs, Counties/Municipalities, Residential, Railroad and Mining market projects
- AASHTO Section 12 includes external ribs as part of the overall design specification
- Patent Pending Design

Typical External Rib Detail

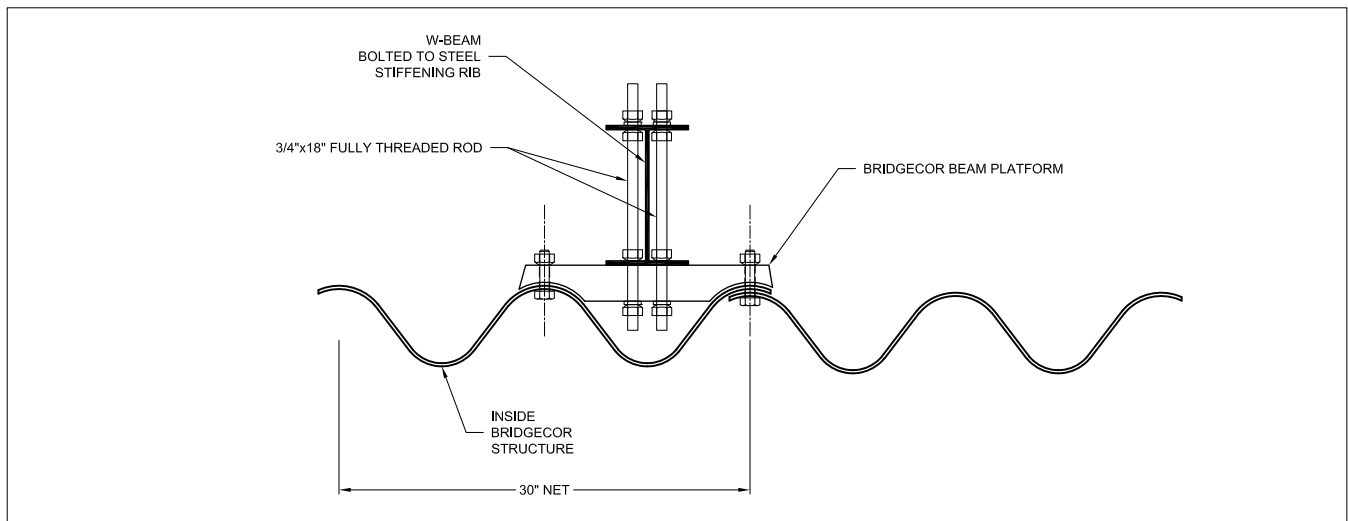

Typical External Rib System Assembly



BridgeCor External Rib System with Welded Wire Wall (64'-2" x 19'-7") during construction



BridgeCor External Rib System after construction



BridgeCor External Rib System

TABLE 70. BRIDGECOR ROUND PIPE 15" X 5½"
LRFD HEIGHT OF COVER GUIDE (HL-93 LOADING)

Dimensions to Inside Corrugation				Gage Thickness (Inches) Maximum Cover Height Shown in Feet							Precon (Min. Level)
Diameter (Ft.-In.)	Approx. Area (Sq. Ft.)	Min. Cover (Feet)	Total S	8 (0.170)	7 (0.188)	5 (0.218)	3 (0.249)	1 (0.280)	5/16 (0.318)	3/8 (0.380)	
19-11	311	2.5	48	21	25	30	35	40	45	50	1
20-9	339	2.5	50	20	23	28	33	38	43	48	1
21-7	367	2.5	52	18	21	26	31	36	41	46	1
22-6	396	2.5	54	17	19	25	29	33	38	43	1
23-4	427	2.5	56	16	19	24	28	32	37	42	1
24-2	459	2.5	58	15	18	23	27	30	35	40	1
25-0	491	2.5	60	14	17	22	26	29	34	39	1
25-10	525	2.5	62	14	17	22	25	28	32	37	1
26-8	560	2.5	64	13	16	21	24	27	31	35	1
27-7	596	2.5	66	13	15	21	24	26	30	34	1
28-5	634	2.5	68	12	15	20	23	25	29	33	1
29-3	672	2.5	70	12	15	20	22	24	28	32	1
30-1	712	2.5	72	12	14	19	21	23	26	30	1
30-11	752	2.5	74	11	14	18	20	22	25	29	2
31-10	794	3.0	76	11	14	18	20	22	25	28	2
32-8	837	3.0	78	11	13	17	19	21	24	27	2
33-6	881	3.0	80	10	13	17	19	20	23	26	2
34-4	926	3.0	82	10	13	17	18	20	23	26	2
35-2	973	3.0	84	9	13	16	18	19	22	25	2
36-0	1020	3.0	86		13	16	17	18	21	24	2
36-11	1069	3.0	88		12	15	17	18	21	24	3
37-9	1119	3.0	90			15	16	17	20	23	3
38-7	1170	3.0	92			15	16	17	20	22	3
39-5	1222	3.0	94			14	15	16	19	21	3
40-3	1275	3.0	96				15	16	19	21	3
41-2	1329	3.0	98				15	16	18	20	3
42-0	1384	3.0	100				14	15	17	19	4
42-10	1441	3.0	102				14	15	17	19	4
43-8	1499	3.0	104					14	16	18	4
44-6	1557	3.0	106					14	16	19	4
45-5	1617	3.0	108					13	15	16	4
46-3	1679	3.0	110					13	14	15	4
47-1	1741	3.0	112						15	16	4
47-11	1804	3.0	114						15	16	4
48-9	1868	3.0	116						14	15	4
49-7	1934	3.5	118						14	15	4
50-6	2001	3.5	120							15	4

Notes:

1. **Not for a specific structural design. Use for budget estimating only. Finite Element Analysis (CANDE) is required for final design and quotation.**
2. The above table is based upon the general requirements of the AASHTO LRFD Design Specification, Section 12, and:
 - a. These tables are based upon a trench condition installation. A finite element analysis is required to determine this width in an embankment installation.
 - b. Backfill material per AASHTO M 145. For estimating, assume any A-1 material.
With specific site information, alternate backfill materials may be allowed. Refer to Table 69 (pg. 93).
 - c. **Select backfill 120 pcf in density and compacted to a minimum 90% density per AASHTO T-180.**
 - d. The minimum cover is the vertical distance from the mid-depth (neutral axis) of the corrugations to the top of rigid or bottom of flexible pavement per AASHTO 12.8.9.4
 - e. A minimum select backfill width of 8 feet was used when analyzing the table above. Other widths may be acceptable based on an alternate finite element analysis. This width was measured from outside the maximum span on each side of the structure. This width only applies when the material adjacent to the select zone is determined to be competent, well consolidated material.
3. Select backfill width may increase for situations where lower strength fill exists in either the select fill zone or the adjacent embankment zone.
4. This estimate is for single barrel structures. For multiple barrels, more investigation is required.

TABLE 71. BRIDGECOR ROUND PIPE 15" X 5½"

WEIGHT TABLES								
Inside Diameter		Gage Thickness (Inches) Weight Shown as Pounds per Foot of Structure						
Diameter (Ft.-In.)	Total S	8 (0.170)	7 (0.188)	5 (0.218)	3 (0.249)	1 (0.280)	5/16 (0.318)	3/8 (0.380)
19-11	48	680	750	867	987	1107	1325	1574
20-9	50	706	779	900	1025	1149	1375	1635
21-7	52	731	808	933	1063	1191	1426	1696
22-6	54	757	837	966	1101	1234	1476	1757
23-4	56	793	875	1012	1152	1292	1546	1837
24-2	58	819	904	1045	1190	1334	1596	1898
25-0	60	845	933	1078	1227	1376	1646	1958
25-10	62	870	962	1111	1265	1418	1697	2019
26-8	64	907	1001	1156	1316	1476	1766	2099
27-7	66	932	1029	1189	1354	1518	1817	2160
28-5	68	958	1058	1222	1392	1561	1867	2221
29-3	70	983	1087	1255	1430	1603	1918	2282
30-1	72	1009	1116	1289	1468	1645	1968	2342
30-11	74	1046	1154	1334	1519	1703	2038	2422
31-10	76	1071	1183	1367	1557	1745	2088	2483
32-8	78	1097	1212	1400	1594	1787	2138	2544
33-6	80	1122	1241	1433	1632	1829	2189	2605
34-4	82	1159	1279	1478	1683	1887	2258	2685
35-2	84	1185	1308	1511	1721	1930	2309	2746
36-0	86		1337	1545	1759	1972	2359	2806
36-11	88		1366	1578	1797	2014	2410	2867
37-9	90			1611	1835	2056	2460	2928
38-7	92			1656	1886	2114	2530	3008
39-5	94			1689	1923	2156	2580	3069
40-3	96				1961	2198	2630	3130
41-2	98				1999	2241	2681	3190
42-0	100				2050	2299	2750	3270
42-10	102				2088	2341	2801	3331
43-8	104					2383	2851	3392
44-6	106					2425	2902	3453
45-5	108					2467	2952	3514
46-3	110					2525	3022	3594
47-1	112						3072	3654
47-11	114						3122	3715
48-9	116						3173	3776
49-7	118						3242	3856
50-6	120							3917

Notes:

1. Custom shapes and alternate sizes are available. Please contact your Contech representative.
2. Weights include fasteners for assembly.
3. Weights include a galvanized coating which is 3 ounces per square foot, total both sides.
4. For structure plate make-up information, please contact your Contech representative.

TABLE 72. BRIDGECOR SINGLE RADIUS ARCH 15" X 5 1/2"

LRFD HEIGHT OF COVER GUIDE (HL-93 LOADING)

Dimensions to Inside Corrugation					Gage Thickness (Inches) Maximum Height of Cover Shown in Feet							Precon (min Level)
Bottom Span (Ft.-In.)	Rise (Ft.-In.)	Approx. Area (Sq. Ft.)	Min Cover (Feet)	Total S	8 (0.170)	7 (0.188)	5 (0.218)	3 (0.249)	1 (0.280)	5/16 (0.318)	3/8 (0.380)	
19-7	9-9	150	2.0	23	20	24	29	34	39	44	49	1
19-10	5-0	66	2.0	17	19	23	28	32	36	41	46	1
20-5	10-2	164	2.0	24	19	22	27	32	37	42	47	1
21-3	10-7	177	2.0	25	18	21	26	31	36	40	45	1
22-1	11-0	192	2.0	26	17	20	25	30	34	39	44	1
22-10	11-6	207	2.0	27	17	20	25	29	33	37	42	1
23-10	11-11	222	2.0	28	16	19	24	28	32	36	40	1
24-8	12-4	238	2.0	29	15	18	23	27	30	34	38	1
24-8	6-0	103	2.0	21	15	17	21	25	28	31	34	1
25-6	12-9	255	2.0	30	14	17	21	25	29	33	37	1
26-4	13-2	272	2.0	31	14	17	21	25	28	31	35	1
27-2	13-7	290	2.0	32	13	16	20	24	27	30	34	2
28-0	14-0	309	2.0	33	12	15	19	23	26	29	33	2
28-10	7-5	149	2.0	25	11	13	16	20	24	27	30	2
28-10	14-5	328	2.0	34	12	14	18	21	25	28	32	2
29-8	14-10	347	2.0	35	11	14	17	21	24	28	31	2
30-6	15-3	367	2.0	36	11	13	16	19	23	26	29	2
31-6	15-9	388	2.0	37	11	13	16	19	22	25	28	2
32-4	16-1	409	2.0	38	10	12	15	18	21	24	27	2
33-2	16-7	431	2.0	39	10	11	14	17	20	23	26	2
34-0	17-0	453	2.0	40	10	11	14	17	19	23	25	2
34-1	9-2	219	2.0	30	10	11	14	17	19	21	23	2
35-8	17-10	500	2.0	42	9	11	13	16	18	20	22	2
37-0	18-9	548	2.0	44		11	13	15	17	19	21	2
38-11	10-2	278	2.0	34		10	12	14	16	18	20	2
39-0	19-6	599	2.0	46		10	12	14	16	18	19	2
40-8	20-4	653	2.0	48			12	13	15	16	17	3
42-6	21-3	708	2.0	50			12	13	14	15	16	3
44-2	22-1	766	2.0	52			11	12	13	14	15	3
45-10	22-11	826	2.0	54			10	11	12	13	14	3
46-0	11-9	380	2.0	40				12	12	13	14	3
49-2	24-7	953	2.5	58					11	13	14	3
51-0	25-6	1019	2.5	60					10	13	14	3
52-8	26-4	1088	3.0	62						12	13	3
54-4	27-2	1160	3.5	64						11	12	3

Notes:

1. **Not for a specific structural design. Use for budget estimating only. Finite Element Analysis (CANDE) is required for final design and quotation.**
2. The above table is based upon the general requirements of the AASHTO LRFD Design Specification, Section 12, and:
 - a. These tables are based upon a trench condition installation. A finite element analysis is required to determine this width in an embankment installation.
 - b. Backfill material per AASHTO M 145. For estimating, assume any A-1 material.
With specific site information, alternate backfill materials may be allowed. Refer to Table 69 (pg. 93).
 - c. **Select backfill 120 pcf in density and compacted to a minimum 90% density per AASHTO T-180.**
 - d. The minimum cover is the vertical distance from the mid-depth (neutral axis) of the corrugations to the top of rigid or bottom of flexible pavement per AASHTO 12.8.9.4
 - e. A minimum select backfill width of 8 feet was used when analyzing the table above. Other widths may be acceptable based on an alternate finite element analysis. This width was measured from outside the maximum span on each side of the structure. This width only applies when the material adjacent to the select zone is determined to be competent, well consolidated material.
3. Select backfill width may increase for situations where lower strength fill exists in either the select fill zone or the adjacent embankment zone.
4. This estimate is for single barrel structures. For multiple barrels, more investigation is required.

TABLE 73. BRIDGECOR SINGLE RADIUS ARCH 15" X 5½"

WEIGHT TABLES									
Dimensions to Inside Corrugation			Gage Thickness (Inches) Weight Shown as Pounds per Foot of Structure						
Bottom Span (Ft.-In.)	Rise (Ft.-In.)	Total S	8 (0.170)	7 (0.188)	5 (0.218)	3 (0.249)	1 (0.280)	5/16 (0.318)	3/8 (0.380)
19-7	9-9	23	325	358	414	472	530	631	751
19-10	5-0	17	237	262	303	345	387	461	549
20-5	10-2	24	337	373	431	491	551	656	781
21-3	10-7	25	350	387	447	510	572	681	811
22-1	11-0	26	363	401	464	529	593	707	842
22-10	11-6	27	386	427	493	561	629	751	893
23-10	11-11	28	399	440	509	580	650	776	923
24-8	12-4	29	412	455	526	599	671	801	953
24-8	6-0	21	299	330	381	434	487	581	691
25-6	12-9	30	425	469	542	618	693	827	983
26-4	13-2	31	438	483	559	636	714	852	1013
27-2	13-7	32	451	498	575	655	735	877	1044
28-0	14-0	33	463	512	592	674	756	902	1074
28-10	7-5	25	350	387	447	510	572	681	811
28-10	14-5	34	476	526	608	693	778	927	1104
29-8	14-10	35	489	541	625	712	799	953	1135
30-6	15-3	36	513	566	654	744	835	997	1186
31-6	15-9	37	525	580	670	763	856	1022	1216
32-4	16-1	38	538	594	687	782	877	1047	1246
33-2	16-7	39	551	608	703	801	899	1073	1276
34-0	17-0	40	564	623	720	820	920	1098	1306
34-1	9-2	30	425	469	542	618	693	827	983
35-8	17-10	42	590	651	753	858	962	1148	1367
37-0	18-9	44		680	786	896	1004	1199	1427
38-11	10-2	34		526	608	693	778	927	1104
39-0	19-6	46		719	831	947	1062	1268	1508
40-8	20-4	48			864	984	1104	1319	1569
42-6	21-3	50			898	1022	1147	1369	1629
44-2	22-1	52			931	1060	1189	1419	1690
45-10	22-11	54			976	1111	1246	1489	1771
46-0	11-9	40				820	920	1098	1306
49-2	24-7	58					1331	1590	1891
51-0	25-6	60					1373	1640	1952
52-8	26-4	62							2013
54-4	27-2	64							2093

Notes:

1. Custom shapes and alternate sizes are available. Please contact your Contech representative.
2. Weights include fasteners for assembly.
3. Weights include a galvanized coating which is 3 ounces per square foot, total both sides.
4. For structure plate make-up information, please contact your Contech representative.
5. If Unbalanced Channels are supplied, add 20 pounds per foot to the structure length.

TABLE 74. BRIDGECOR 2-RADIUS ARCH 15 X 5½

LRFD HEIGHT OF COVER GUIDE (HL-93 LOADING)

Dimensions to Inside Corrugation				Gage Thickness (Inches) - Height of Cover Shown in Feet Maximum Height of Cover (Minimum Height of Cover)							Precon (min Level)
Maximum Span (Ft.-In.)	Rise (Ft.-In.)	Approx. Area (Sq. Ft.)	Total S	8 (0.170)	7 (0.188)	5 (0.218)	3 (0.249)	1 (0.280)	5/16 (0.318)	3/8 (0.380)	
18-5	8-4	124	21	20 (2.0)	24 (2.0)	28 (1.5)	33 (1.5)	38 (1.5)	43 (1.5)	48 (1.5)	2
22-0	10-0	173	25	17 (2.0)	21 (2.0)	25 (1.5)	29 (1.5)	34 (1.5)	39 (1.5)	44 (1.5)	2
23-5	9-3	172	25	15 (2.0)	18 (2.0)	21 (1.5)	24 (1.5)	27 (1.5)	30 (1.5)	33 (1.5)	2
25-5	11-7	228	29	14 (2.0)	17 (2.0)	20 (2.0)	23 (2.0)	26 (2.0)	29 (2.0)	33 (2.0)	2
26-11	10-10	233	29	13 (2.5)	16 (2.0)	19 (2.0)	22 (2.0)	25 (2.0)	29 (2.0)	33 (2.0)	2
27-2	9-10	212	28	12 (2.5)	14 (2.5)	16 (2.0)	18 (2.0)	20 (2.0)	23 (2.0)	26 (2.0)	2
28-11	13-2	306	33	12 (2.0)	15 (2.0)	18 (2.0)	21 (2.0)	24 (2.0)	27 (2.0)	30 (2.0)	2
31-8	12-8	320	34	10 (2.5)	12 (2.0)	15 (2.0)	18 (2.0)	21 (2.0)	24 (2.0)	27 (2.0)	2
31-11	11-8	295	33	10 (2.5)	12 (2.5)	14 (2.0)	16 (2.0)	18 (2.0)	20 (2.0)	23 (2.0)	2
32-2	10-8	271	32	9 (2.0)	10 (2.0)	11 (2.0)	12 (2.0)	14 (2.0)	16 (2.0)	18 (2.0)	2
32-5	14-9	385	37	9 (2.0)	11 (2.0)	14 (2.0)	17 (2.0)	20 (2.0)	23 (2.0)	26 (2.0)	2
35-10	11-4	318	35	7 (2.0)	8 (2.0)	9 (2.0)	10 (2.0)	11 (2.0)	12 (2.0)	14 (2.0)	2
35-11	16-5	473	41	9 (2.0)	11 (2.0)	13 (2.0)	15 (2.0)	17 (2.0)	20 (2.0)	23 (2.0)	2
36-5	14-5	420	39	9 (2.0)	11 (2.0)	13 (2.0)	15 (2.0)	17 (2.0)	20 (2.0)	23 (2.0)	2
37-10	13-8	412	39	8 (2.5)	11 (2.0)	13 (2.0)	14 (2.0)	16 (2.0)	18 (2.0)	20 (2.0)	2
38-1	12-9	382	38	8 (2.0)	9 (2.0)	10 (2.0)	11 (2.0)	12 (2.0)	14 (2.5)	16 (2.0)	3
39-5	18-0	569	45		10 (2.0)	12 (2.0)	14 (2.0)	16 (2.0)	18 (2.0)	20 (2.0)	3
39-11	16-1	512	43		10 (2.0)	12 (2.0)	14 (2.0)	16 (2.0)	18 (2.0)	21 (2.0)	3
40-10	12-2	387	39			6 (2.0)	7 (2.0)	8 (2.0)	9 (2.0)	10 (2.0)	3
42-7	15-6	525	44		9 (2.0)	11 (2.0)	13 (2.0)	15 (2.0)	17 (2.0)	19 (2.0)	3
42-11	19-7	675	49			12 (2.0)	14 (2.0)	15 (2.0)	17 (2.0)	18 (2.0)	3
43-1	13-7	458	42			8 (2.0)	9 (2.0)	10 (2.0)	11 (2.0)	12 (2.0)	3
44-1	14-9	513	44			9 (2.0)	10 (2.0)	11 (2.0)	12 (2.0)	13 (2.0)	3
44-7	17-10	637	48			11 (2.0)	13 (2.0)	14 (2.0)	16 (2.0)	18 (2.0)	3
46-5	21-2	790	53			10 (2.0)	12 (2.0)	13 (2.0)	14 (2.0)	16 (2.0)	3
47-4	17-4	652	49			10 (2.0)	11 (2.0)	12 (2.0)	14 (2.0)	16 (2.0)	4
48-0	14-5	539	46			5 (2.0)	6 (2.0)	7 (2.0)	8 (2.0)	9 (2.0)	4
48-1	19-6	749	52			10 (2.0)	12 (2.0)	13 (2.0)	14 (2.0)	16 (2.0)	4
48-7	17-7	676	50			9 (2.0)	11 (2.0)	12 (2.0)	14 (2.0)	16 (2.0)	4
49-11	22-10	914	57				10 (2.0)	11 (2.0)	13 (2.0)	15 (2.0)	4
50-0	16-10	662	50				8 (2.5)	10 (2.5)	12 (2.5)	14 (2.0)	4
50-3	15-10	623	49				7 (2.5)	8 (2.5)	9 (2.5)	10 (2.0)	4
50-7	19-11	804	54				11 (2.5)	12 (2.5)	13 (2.5)	15 (2.0)	4

Notes:

1. **Not for a specific structural design. Use for budget estimating only. Finite Element Analysis (CANDE) is required for final design and quotation.**
2. The above table is based upon the general requirements of the AASHTO LRFD Design Specification, Section 12, and:
 - a. These tables are based upon a trench condition installation. A finite element analysis is required to determine this width in an embankment installation.
 - b. Backfill material per AASHTO M 145. For estimating, assume any A-1 material.
With specific site information, alternate backfill materials may be allowed. Refer to Table 69 (pg. 93).
 - c. **Select backfill 120 pcf in density and compacted to a minimum 90% density per AASHTO T-180.**
 - d. The minimum cover is the vertical distance from the mid-depth (neutral axis) of the corrugations to the top of rigid or bottom of flexible pavement per AASHTO 12.8.9.4
 - e. A minimum select backfill width of 8 feet was used when analyzing the table above. Other widths may be acceptable based on an alternate finite element analysis. This width was measured from outside the maximum span on each side of the structure. This width only applies when the material adjacent to the select zone is determined to be competent, well consolidated material.
3. Select backfill width may increase for situations where lower strength fill exists in either the select fill zone or the adjacent embankment zone.
4. This estimate is for single barrel structures. For multiple barrels, more investigation is required.

TABLE 75. BRIDGECOR 2-RADIUS ARCH 15" X 5½"

WEIGHT TABLES									
Dimensions to Inside Corrugation			Gage Thickness (Inches) Weight Shown as Pounds per Foot of Structure						
Maximum Span (Ft.-In.)	Rise (Ft.-In.)	Total S	8 (0.170)	7 (0.188)	5 (0.218)	3 (0.249)	1 (0.280)	5/16 (0.318)	3/8 (0.380)
18-5	8-4	21	299	330	381	434	487	581	691
22-0	10-0	25	350	387	447	510	572	681	811
23-5	9-3	25	350	387	447	510	572	681	811
25-5	11-7	29	412	455	526	599	672	801	954
26-11	10-10	29	412	455	526	599	672	801	954
27-2	9-10	28	399	441	509	580	650	776	923
28-11	13-2	33	474	523	604	687	771	921	1096
31-8	12-8	34	476	526	608	693	778	927	1104
31-11	11-8	33	463	512	592	674	756	902	1074
32-2	10-8	32	451	498	575	655	735	877	1044
32-5	14-9	37	525	580	670	763	856	1022	1216
35-10	11-4	35	489	541	625	712	799	953	1135
35-11	16-5	41	577	637	736	839	941	1123	1337
36-5	14-5	39	571	620	716	814	913	1092	1298
37-10	13-8	39	561	608	703	801	898	1072	1276
38-1	12-9	38	538	594	687	782	877	1047	1246
39-5	18-0	45		705	815	928	1040	1243	1478
39-11	16-1	43		676	782	890	998	1192	1418
40-10	12-2	39			703	801	899	1073	1276
42-7	15-6	44		702	811	922	1034	1237	1470
42-11	19-7	49			871	1003	1126	1344	1599
43-1	13-7	42			753	858	962	1148	1367
44-1	14-9	44			786	896	1004	1199	1427
44-7	17-10	48			864	984	1104	1319	1569
46-5	21-2	53			947	1079	1210	1445	1720
47-4	17-4	49			883	1016	1140	1363	1621
48-0	14-5	46			831	947	1062	1268	1508
48-1	19-6	52			931	1060	1189	1419	1690
48-7	17-7	50			910	1035	1162	1388	1651
49-11	22-10	57				1167	1310	1565	1861
50-0	16-10	50				1048	1176	1407	1673
50-3	15-10	49				1003	1126	1344	1599
50-7	19-11	54				1111	1246	1489	1771

Notes:

1. Custom shapes and alternate sizes are available. Please contact your Contech representative.
2. Weights include fasteners for assembly.
3. Weights include a galvanized coating which is 3 ounces per square foot, total both sides.
4. For structure plate make-up information, please contact your Contech representative.
5. If Unbalanced Channels are supplied, add 20 pounds per foot to the structure length.

TABLE 76. BRIDGECOR BOX CULVERT 15 X 5½

LRFD HEIGHT OF COVER GUIDE (HL-93 LOADING)

Dimensions to Inside Corrugation			Gage Thickness (Inches) - Minimum Height of Cover Shown in Feet 5' Maximum Height of Cover (See Note 6)								Precon (min Level)
Bottom Span (Ft.-In.)	Rise (Ft.-In.)	Approx. Area (Sq. Ft.)	Total S	8 (0.170)	7 (0.188)	5 (0.218)	3 (0.249)	1 (0.280)	5/16 (0.318)	3/8 (0.380)	
20-0	5-7	93	19	2.25	2.0	1.5	1.5	1.5	1.5	1.5	1
20-7	6-10	119	21	2.25	2.0	1.5	1.5	1.5	1.5	1.5	1
20-10	8-2	145	23	2.25	2.0	1.5	1.5	1.5	1.5	1.5	1
21-0	5-10	102	20	2.25	2.0	1.5	1.5	1.5	1.5	1.5	1
21-5	7-2	130	22	2.25	2.0	1.5	1.5	1.5	1.5	1.5	1
21-9	8-6	157	24	2.25	2.0	1.5	1.5	1.5	1.5	1.5	1
22-0	9-10	186	26	2.25	2.0	1.5	1.5	1.5	1.5	1.5	1
22-4	6-1	112	21	2.25	2.0	1.5	1.5	1.5	1.5	1.5	1
22-10	7-4	141	23	2.25	2.0	1.5	1.5	1.5	1.5	1.5	1
23-3	8-8	171	25	2.25	2.0	1.5	1.5	1.5	1.5	1.5	1
23-6	6-4	123	22	2.25	2.0	1.5	1.5	1.5	1.5	1.5	1
23-6	10-0	200	27	2.25	2.0	1.5	1.5	1.5	1.5	1.5	1
24-0	7-8	153	24	2.25	2.0	1.5	1.5	1.5	1.5	1.5	1
24-4	8-11	184	26	2.25	2.0	1.5	1.5	1.5	1.5	1.5	1
24-8	6-7	133	23	2.25	2.0	1.5	1.5	1.5	1.5	1.5	1
25-2	7-11	165	25	2.25	2.0	2.0	2.0	2.0	2.0	2.0	1
25-6	9-3	198	27	2.25	2.0	2.0	2.0	2.0	2.0	2.0	1
25-9	10-6	231	29	2.25	2.0	2.0	2.0	2.0	2.0	2.0	1
26-0	6-10	145	24	2.25	2.0	2.0	2.0	2.0	2.0	2.0	2
26-6	8-1	178	26	2.25	2.0	2.0	2.0	2.0	2.0	2.0	2
26-11	7-2	157	25	2.25	2.0	2.0	2.0	2.0	2.0	2.0	2
27-3	10-9	247	30	2.25	2.0	2.0	2.0	2.0	2.0	2.0	2
27-8	9-10	227	29	2.25	2.0	2.0	2.0	2.0	2.0	2.0	2
28-2	8-10	192	27	2.25	2.0	2.0	2.0	2.0	2.0	2.0	2

Notes:

1. Custom shapes and alternate sizes are available. Please contact your Contech representative.
2. **Not for a specific structural design. Use for budget estimating only. Finite Element Analysis (CANDE) is required for final design and quotation.**
3. The above table is based upon the general requirements of the AASHTO LRFD Design Specification, Section 12, and:
 - a. These tables are based upon a trench condition installation. A finite element analysis is required to determine this width in an embankment installation.
 - b. Backfill material per AASHTO M 145. For estimating, assume any A-1 material.
With specific site information, alternate backfill materials may be allowed. Refer to Table 69 (pg. 93).
 - c. **Select backfill 120 pcf in density and compacted to a minimum 90% density per AASHTO T-180.**
 - d. The minimum cover is the vertical distance from the mid-depth (neutral axis) of the corrugations to the top of rigid or bottom of flexible pavement per AASHTO 12.8.9.4
 - e. A minimum select backfill width of 8 feet was used when analyzing the table above. Other widths may be acceptable based on an alternate finite element analysis. This width was measured from outside the maximum span on each side of the structure. This width only applies when the material adjacent to the select zone is determined to be competent, well consolidated material.
4. Select backfill width may increase for situations where lower strength fill exists in either the select fill zone or the adjacent embankment zone.
5. This estimate is for single barrel structures. For multiple barrels, more investigation is required.
6. If the maximum cover on the box culvert structure exceeds 5', please consider changing the structure to a 2-radius arch for more efficient load handling capability.

TABLE 77. BRIDGECOR BOX CULVERT 15 X 5½

LRFD HEIGHT OF COVER GUIDE (HL-93 LOADING)

Dimensions to Inside Corrugation			Gage Thickness (Inches) - Minimum Height of Cover Shown in Feet 5' Maximum Height of Cover (See Note 6)								Precon (Min Level)
Bottom Span (Ft.-In.)	Rise (Ft.-In.)	Approx. Area (Sq. Ft.)	Total S	8 (0.170)	7 (0.188)	5 (0.218)	3 (0.249)	1 (0.280)	5/16 (0.318)	3/8 (0.380)	
27-11	11-1	263	31	2.25	2.0	2.0	2.0	2.0	2.0	2.0	2
28-3	7-5	169	27	2.25	2.0	2.0	2.0	2.0	2.0	2.0	2
28-9	8-11	206	28	2.25	2.0	2.0	2.0	2.0	2.0	2.0	2
29-2	10-0	243	30	2.25	2.0	2.0	2.0	2.0	2.0	2.0	2
29-5	11-4	280	32	2.25	2.0	2.0	2.0	2.0	2.0	2.0	2
29-7	7-7	182	27	2.25	2.0	2.0	2.0	2.0	2.0	2.0	2
30-1	8-11	220	29	2.25	2.0	2.0	2.0	2.0	2.0	2.0	2
30-7	10-3	259	31	2.25	2.0	2.0	2.0	2.0	2.0	2.0	2
30-10	11-6	298	33	2.25	2.0	2.0	2.0	2.0	2.0	2.0	2
31-3	9-3	236	30	2.25	2.0	2.0	2.0	2.0	2.0	2.0	2
31-7	8-4	210	29	2.25	2.0	2.0	2.0	2.0	2.0	2.0	2
31-8	10-6	275	32	2.25	2.0	2.0	2.0	2.0	2.0	2.0	2
32-1	9-7	251	31		2.0	2.0	2.0	2.0	2.0	2.0	2
32-8	12-3	334	35		2.0	2.0	2.0	2.0	2.0	2.0	2
32-11	8-6	224	30		2.0	2.0	2.0	2.0	2.0	2.0	2
33-5	9-10	267	32		2.0	2.0	2.0	2.0	2.0	2.0	2
33-10	11-2	310	34		2.0	2.0	2.0	2.0	2.0	2.0	2
34-0	8-10	240	31		2.0	2.0	2.0	2.0	2.0	2.0	2
34-6	10-2	284	33		2.0	2.0	2.0	2.0	2.0	2.0	2
34-11	11-6	328	35		2.0	2.0	2.0	2.0	2.0	2.0	2
35-1	9-2	255	32		2.0	2.0	2.0	2.0	2.0	2.0	2
35-2	12-9	373	37		2.0	2.0	2.0	2.0	2.0	2.0	2
35-7	10-6	301	34		2.0	2.0	2.0	2.0	2.0	2.0	2
36-2	9-6	272	33		2.5	2.5	2.5	2.5	2.5	2.5	2
36-2	13-1	393	38		2.5	2.5	2.5	2.5	2.5	2.5	2

Notes:

1. Custom shapes and alternate sizes are available. Please contact your Contech representative.
2. **Not for a specific structural design. Use for budget estimating only. Finite Element Analysis (CANDE) is required for final design and quotation.**
3. The above table is based upon the general requirements of the AASHTO LRFD Design Specification, Section 12, and:
 - a. These tables are based upon a trench condition installation. A finite element analysis is required to determine this width in an embankment installation.
 - b. Backfill material per AASHTO M 145. For estimating, assume any A-1 material.
With specific site information, alternate backfill materials may be allowed. Refer to Table 69 (pg. 93).
 - c. **Select backfill 120 pcf in density and compacted to a minimum 90% density per AASHTO T-180.**
 - d. The minimum cover is the vertical distance from the mid-depth (neutral axis) of the corrugations to the top of rigid or bottom of flexible pavement per AASHTO 12.8.9.4
 - e. A minimum select backfill width of 8 feet was used when analyzing the table above. Other widths may be acceptable based on an alternate finite element analysis. This width was measured from outside the maximum span on each side of the structure. This width only applies when the material adjacent to the select zone is determined to be competent, well consolidated material.
4. Select backfill width may increase for situations where lower strength fill exists in either the select fill zone or the adjacent embankment zone.
5. This estimate is for single barrel structures. For multiple barrels, more investigation is required.
6. If the maximum cover on the box culvert structure exceeds 5', please consider changing the structure to a 2-radius arch for more efficient load handling capability.

TABLE 78. BRIDGECOR BOX CULVERT 15 X 5½

LRFD HEIGHT OF COVER GUIDE (HL-93 LOADING)

Dimensions to Inside Corrugation			Gage Thickness (Inches) - Minimum Height of Cover Shown in Feet 5' Maximum Height of Cover (See Note 6)								Precon (Min Level)
Bottom Span (Ft.-In.)	Rise (Ft.-In.)	Approx. Area (Sq. Ft.)	Total S	8 (0.170)	7 (0.188)	5 (0.218)	3 (0.249)	1 (0.280)	5/16 (0.318)	3/8 (0.380)	
36-8	10-10	318	35		2.5	2.5	2.5	2.5	2.5	2.5	2
37-0	12-2	366	37		2.5	2.5	2.5	2.5	2.5	2.5	2
37-3	13-5	414	39		2.5	2.5	2.5	2.5	2.5	2.5	2
37-6	9-9	288	34		2.5	2.5	2.5	2.5	2.5	2.5	2
38-7	10-1	306	35		3.0	3.0	3.0	3.0	3.0	3.0	2
38-8	13-8	435	40		3.0	3.0	3.0	3.0	3.0	3.0	2
39-1	11-5	355	37		3.0	3.0	3.0	3.0	3.0	3.0	2
39-9	14-0	456	41		3.0	3.0	3.0	3.0	3.0	3.0	2
39-10	10-4	323	36		3.0	3.0	3.0	3.0	3.0	3.0	3
40-5	11-7	375	38		3.0	3.0	3.0	3.0	3.0	3.0	3
40-10	12-11	426	40		3.0	3.0	3.0	3.0	3.0	3.0	3
41-2	14-3	479	42		3.0	3.0	3.0	3.0	3.0	3.0	3
40-11	10-8	342	37		3.0	3.0	3.0	3.0	3.0	3.0	4
41-6	11-11	394	39		3.0	3.0	3.0	3.0	3.0	3.0	4
41-11	13-3	448	41		3.0	3.0	3.0	3.0	3.0	3.0	4
42-2	14-7	501	43		3.0	3.0	3.0	3.0	3.0	3.0	4
42-8	11-7	384	39		3.0	3.0	3.0	3.0	3.0	3.0	4
43-0	12-11	441	41		3.0	3.0	3.0	3.0	3.0	3.0	4
43-4	14-2	499	43		3.0	3.0	3.0	3.0	3.0	3.0	4
44-3	12-6	431	41		3.0	3.0	3.0	3.0	3.0	3.0	4
44-8	15-2	550	45		3.0	3.0	3.0	3.0	3.0	3.0	4
45-0	13-0	456	42		3.0	3.0	3.0	3.0	3.0	3.0	4
45-3	14-4	517	44		3.0	3.0	3.0	3.0	3.0	3.0	4
45-4	15-8	577	46		3.0	3.0	3.0	3.0	3.0	3.0	4
46-3	13-3	481	43		3.0	3.0	3.0	3.0	3.0	3.0	4

Notes:

1. Custom shapes and alternate sizes are available. Please contact your Contech representative.
2. **Not for a specific structural design. Use for budget estimating only. Finite Element Analysis (CANDE) is required for final design and quotation.**
3. The above table is based upon the general requirements of the AASHTO LRFD Design Specification, Section 12, and:
 - a. These tables are based upon a trench condition installation. A finite element analysis is required to determine this width in an embankment installation.
 - b. Backfill material per AASHTO M 145. For estimating, assume any A-1 material.
With specific site information, alternate backfill materials may be allowed. Refer to Table 69 (pg. 93).
 - c. **Select backfill 120 pcf in density and compacted to a minimum 90% density per AASHTO T-180.**
 - d. The minimum cover is the vertical distance from the mid-depth (neutral axis) of the corrugations to the top of rigid or bottom of flexible pavement per AASHTO 12.8.9.4
 - e. A minimum select backfill width of 8 feet was used when analyzing the table above. Other widths may be acceptable based on an alternate finite element analysis. This width was measured from outside the maximum span on each side of the structure. This width only applies when the material adjacent to the select zone is determined to be competent, well consolidated material.
4. Select backfill width may increase for situations where lower strength fill exists in either the select fill zone or the adjacent embankment zone.
5. This estimate is for single barrel structures. For multiple barrels, more investigation is required.
6. If the maximum cover on the box culvert structure exceeds 5', please consider changing the structure to a 2-radius arch for more efficient load handling capability.

TABLE 79. BRIDGECOR BOX CULVERT 15" X 5½"

WEIGHT TABLES									
Dimensions to Inside Corrugation			Gage Thickness (Inches) Weight Shown as Pounds per Foot of Structure						
Total S	Bottom Span (Ft.-In.)	Rise (Ft.-In.)	8 (0.170)	7 (0.188)	5 (0.218)	3 (0.249)	1 (0.280)	5/16 (0.318)	3/8 (0.380)
19	20-0	5-7	273	301	348	396	445	530	631
21	20-7	6-10	299	330	381	434	487	581	691
23	20-10	8-2	325	358	414	472	530	656	781
20	21-0	5-10	286	315	365	415	466	555	661
22	21-5	7-2	312	344	398	453	508	606	721
24	21-9	8-6	337	373	431	491	551	656	781
26	22-0	9-10	363	401	464	529	593	707	842
21	22-4	6-1	299	330	381	434	487	581	691
23	22-10	7-4	325	358	414	472	530	656	781
25	23-3	8-8	350	387	447	510	572	681	811
22	23-6	6-4	312	344	398	453	508	606	721
27	23-6	10-0	386	427	493	561	629	751	893
24	24-0	7-8	337	373	431	491	551	656	781
26	24-4	8-11	363	401	464	529	593	707	842
23	24-8	6-7	335	369	426	485	565	674	802
25	25-2	7-11	360	398	459	523	587	699	832
27	25-6	9-3	386	427	493	561	629	751	893
29	25-9	10-6	412	455	526	599	671	801	953
24	26-0	6-10	347	384	443	504	566	674	802
26	26-6	8-1	373	412	476	542	608	725	863
25	26-11	7-2	360	398	459	523	587	699	832
30	27-3	10-9	425	469	542	618	693	827	983
27	28-2	8-10	386	427	493	561	629	751	893
29	27-8	9-10	412	455	526	599	671	801	953
31	27-11	11-1	438	483	559	636	714	852	1013
26	28-3	7-5	373	412	476	542	608	725	863
28	28-9	8-11	399	440	509	580	650	753	923
30	29-2	10-0	425	469	542	618	693	827	983
32	29-5	11-4	451	498	575	655	735	877	1044
27	29-7	7-7	386	427	493	561	629	751	893
29	30-1	8-11	412	455	526	599	671	801	953
31	30-7	10-3	438	483	559	636	714	852	1013
33	30-10	11-6	466	512	592	674	756	902	1074
30	31-3	9-3	425	469	542	618	693	827	983
29	31-7	8-4	412	455	526	599	671	801	953
32	31-8	10-6	451	498	575	655	735	877	1044
31	32-1	9-7		483	559	636	714	852	1013
35	32-8	12-3		666	769	876	983	1174	1397
30	32-11	8-6		469	542	618	693	827	983

Notes:

1. Custom shapes and alternate sizes are available. Please contact your Contech representative.
2. Weights include fasteners for assembly.
3. Weights include a galvanized coating which is 3 ounces per square foot, total both sides.
4. For structure plate make-up information, please contact your Contech representative.
5. If Unbalanced Channels are supplied, add 20 pounds per foot to the structure length.
6. If the maximum cover on the box culvert structure exceeds 5', please consider changing the structure to a 2-radius arch for more efficient load handling capability.

TABLE 80. BRIDGECOR BOX CULVERT 15" X 5½"

WEIGHT TABLES									
Dimensions to Inside Corrugation			Gage Thickness (Inches) Weight Shown as Pounds per Foot of Structure						
Total S	Bottom Span (Ft.-In.)	Rise (Ft.-In.)	8 (0.170)	7 (0.188)	5 (0.218)	3 (0.249)	1 (0.280)	5/16 (0.318)	3/8 (0.380)
32	33-5	9-10		498	575	655	735	877	1044
34	33-10	11-2		526	608	693	778	927	1104
31	34-0	8-10		483	559	636	714	852	1013
33	34-6	10-2		512	592	674	756	902	1074
35	34-11	11-6		541	625	712	799	953	1135
32	35-1	9-2		509	587	668	750	895	1065
37	35-2	12-9		591	682	776	871	1022	1216
34	35-7	10-6		537	620	706	793	945	1125
33	36-2	9-6		523	604	687	671	920	1095
38	36-2	13-1		594	687	782	877	1048	1546
35	36-8	10-10		552	637	725	814	971	1156
37	37-0	12-2		591	682	776	871	1022	1216
39	37-3	13-5		608	703	801	898	1197	1276
34	37-6	9-9		537	620	706	793	945	1125
38	38-5	12-4		594	687	782	877	1048	1246
35	38-7	10-1		552	637	725	814	971	1156
40	38-8	13-8		623	720	820	919	1098	1306
37	39-1	11-5		591	682	776	871	1022	1216
41	39-9	14-0		637	736	839	941	1123	1336
36	39-10	10-4		569	654	744	834	997	1186
38	40-5	11-7		594	687	782	877	1065	1246
40	40-10	12-11		623	720	820	919	1098	1306
37	40-11	10-8		591	682	776	871	1040	1237
42	41-2	14-3		651	753	858	962	1148	1367
39	41-6	11-11		608	703	801	898	1073	1276
41	41-11	13-3		637	736	839	941	1123	1336
43	42-2	14-7		666	769	876	983	1174	1397
39	42-8	11-7		608	703	801	898	1073	1276
41	43-0	12-11		637	736	839	941	1123	1336
41	44-3	12-6		637	736	839	941	1123	1336
43	43-4	14-2		666	769	876	983	1174	1397
45	44-8	15-2		705	806	920	1035	1244	1475
42	45-0	13-0		651	753	858	962	1148	1367
44	45-3	14-4		681	785	894	1004	1200	1427
46	45-4	15-8		720	822	938	1056	1270	1505
43	46-3	13-3		666	769	876	983	1174	1397

Notes:

1. Custom shapes and alternate sizes are available. Please contact your Contech representative.
2. Weights include fasteners for assembly.
3. Weights include a galvanized coating which is 3 ounces per square foot, total both sides.
4. For structure plate make-up information, please contact your Contech representative.
5. If Unbalanced Channels are supplied, add 20 pounds per foot to the structure length.
6. If the maximum cover on the box culvert structure exceeds 5', please consider changing the structure to a 2-radius arch for more efficient load handling capability.

Steel EXPRESS® Foundations

Contech offers a prefabricated steel stay-in-place bridge foundation form that blends the economy and speed of Contech structural plate with the use of traditional cast-in-place concrete foundations. Steel EXPRESS Foundations (SEF) were introduced to the market in 2017 and have been widely accepted and provided on numerous installations throughout the United States. There are numerous features and benefits associated with the SEF product. For more information on these and the installation process, please refer to the SEF brochure - www.conteches.com/plate.

Advantages

Our SEF improves installation efficiency and accuracy by minimizing construction time in difficult field conditions. Apart from the splice bars between multiple units, there is no need to install any rebar on-site, as it comes pre-installed from our plant. This reduces the risks of any on-site errors for crews with minimal cast-in-place formwork experience, which simplifies field inspections and quality control requirements. SEF sizes and pick weights may be customized to be handled by available on-site equipment.

Applications

Steel EXPRESS Foundations can be used in a variety of applications. With open bottom buried bridges and culverts, they have been used in stream enclosure and wetland crossing project sites. These foundations have also been used in pedestrian, wildlife and vehicular underpass projects. Another application has been as bridge abutments for bridges at grade. These foundations can be adapted for pedestal wall applications and foundations on pile caps.



Steel EXPRESS Foundation Cross Member

Design

Steel EXPRESS Foundations are designed to follow the current AASHTO LRFD Methodology. This methodology is similar to a typical cast-in-place strip foundation design. The parameters needed to design the SEF include the live condition (i.e. HL-93, HS-25, HS-20, etc...), the allowable bearing capacity, the height of cover and the backfill unit weight.

Sizing and Details

SEF are provided in unit lengths of 24'-0" long, typically. However, the length can be modified to fit the required length of the structure. When multiple units are needed for structures lengths longer than 24'-0", the units are field bolted and rebar spliced, end-to-end, to provide a continuous form.

Ideally SEF widths are 8'-0" wide or less, to be able to fit as standard load on a flat-bed truck. However, custom widths over 8'-0" wide can be accommodated to meet the required design.

SEF heights range from 1'-9" to 4'-0". Custom heights may be provided. In addition, a pedestal combination with the foundation can be provided to achieve greater heights.

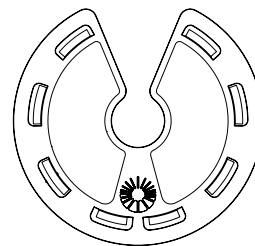

HDPE Rebar Isolator

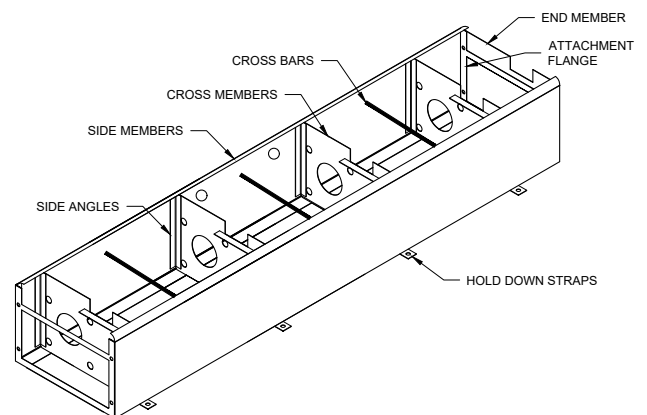



Steel EXPRESS Foundations are typically provided in unit length of 24'



Set footers in place



Pre-assembled plate structure can be set on footers

Steel EXPRESS® Foundations Project Specification

1. Description

- 1.1. Steel EXPRESS® Foundations are a prefabricated metal footing form system that includes all required steel reinforcement.
 - 1.1.1. Type- This specification applies to the manufacture and installation of the Steel EXPRESS® Foundations as detailed in the project plans.
 - 1.1.2. Designation- Steel EXPRESS® Foundation units manufactured in accordance with this specification shall be designated by length, height and width. Foundations shall conform to the lines, grades, design and dimensions shown on the plans or as established by the Engineer.

2. Design

- 2.1. Specifications – The foundation is designed in accordance with the "AASHTO LRFD Bridge Design Specifications" 8th Edition, adopted by the American Association of State Highway and Transportation Officials, 2017.

3. Materials

- 3.1. Steel Forms- The steel utilized in the prefabricated metal footing form system shall conform to AASHTO and ASTM requirements listed below.
 - 3.1.1. Steel shall meet the requirements of ASTM A 1011.
 - 3.1.1.1. All manufacturing processes, including punching, curving and galvanizing shall be performed within the United States using raw materials made in the United States.
 - 3.1.1.2. Galvanizing (if applicable) shall be within industry standard of 3 oz/per square foot total (both sides of galvanized coating) and shall be performed at the Manufacturer owned location. Galvanizing for the prefabricated metal footing form should follow A123.
 - 3.2. Steel Reinforcement
 - 3.2.1. The minimum steel yield strength shall be 60,000 psi, unless otherwise noted on the shop drawings.
 - 3.2.2. All reinforcing steel for the cast-in-place elements shall be fabricated and placed in accordance with the detailed shop drawings submitted by the manufacturer.
 - 3.2.3. Reinforcement shall consist of deformed billet steel bars conforming to ASTM Specification A 615, Grade 60.
 - 3.2.4. Reinforcement shall be isolated from all cross members with Contech Rebar Isolator.
 - 3.3. Steel Hardware
 - 3.3.1. Hardware shall be a maximum of 3/4" diameter hot-dipped galvanized steel (specifically heat-treated) fasteners meeting ASTM A307/A449 specifications are used to assemble joints and members for the steel foundation and galvanized per ASTM A153.

4. Manufacture of Prefabricated Metal Footing Forms

Subject to the provisions of Section 5, enclosed, the prefabricated metal footing forms dimensions and reinforcement details shall be as prescribed in the plan and shop drawings.

- 4.1. Prefabricated Metal Footing Forms-Permissible Variations
 - 4.1.1. Length, height and width of prefabricated metal footing forms shall not vary from that shown in the design by more than 1/2 inch.
 - 4.1.2. Size of Reinforcement - The permissible variation in diameter of any reinforcing shall conform to the tolerances prescribed in the ASTM Specification for that type of reinforcing. Steel area greater than that required shall not be cause for rejection.
- 4.2. Placement of Reinforcement
 - 4.2.1. Placement of reinforcement for prefabricated metal footing forms – The cover of concrete over the bottom reinforcement shall be 3 inches minimum. The cover of concrete for all other reinforcement shall be 2 inches minimum. The clear distance from the end of each steel element to the end of reinforcing steel shall not be less than 2 inches nor more than 3 inches. Reinforcement shall be assembled utilizing a single layer of deformed billet-steel bars.
- 4.3. Storage, Handling & Delivery
 - 4.3.1. **Storage** – The Prefabricated Metal Footing Forms shall be stored in such a manner to prevent damage. Units shall be stored on a flat, level surface to avoid twisting, bending or any deformation of the form.
 - 4.3.2. **Handling** – Handling devices shall be permitted for the weight of each steel foundation unit for the purpose of handling and setting. Units are to be picked from (4) side lifting ports / (2) on each side. Units shall not be pushed or dragged.
 - 4.3.3. **Delivery** – Prefabricated Metal Footing Forms may be unloaded and placed on a level surface at the site until installed.

5. Joints

- 5.1. The steel foundation units shall be produced with flat flanged ends. The ends shall be such that when the sections are laid together they will bolt together with 3/4" diameter hardware provided, all compatible with the permissible variations in section 4.1, above.

6. Repairs

- 6.1. Prefabricated metal footing forms may be repaired, if necessary, because of imperfections in manufacture or handling damage. If galvanized coating is to be repaired, repair must be performed to ASTM A761 (Section 8.4). Manufacturer to work in conjunction with the engineer to determine if the prefabricated metal foundation needs to be repaired.

7. Installation Preparation – To ensure proper installation of the Prefabricated Metal Footing Forms, care and caution must be exercised in shaping the foundation subgrade to allow for the installation of the steel components.

- 7.1. **Footings** – The contractor shall be responsible for the construction of the foundations per the plans and specifications.

Do not over excavate foundations to remove unsuitable soils, unless directed by site soil engineer.

The site soils engineer shall certify that the bearing capacity meets or exceeds the footing

design requirements prior to the contractor setting Prefabricated Metal Footing Forms. The size and elevation of the footings shall be as designed by the Engineer.

The contractor shall prepare a 4-inch thick minimum base layer of compacted granular material the full width of the footing prior to placing the prefabricated metal footing forms.

The finished steel footing surface shall be constructed in accordance with grades shown on the plans. When tested with a 4 foot (min) straight edge, the surface shall not vary more than ¼ inch per ten feet.

The prefabricated steel footing forms must be connected by splice bar reinforcement to form one monolithic body. Splice bars to be supplied by manufacturer and installed by contractor onsite.

8. Installation

8.1. **General** – The installation of the prefabricated steel footing forms shall be per the following;

8.1.1. **Lifting** – The contractor is responsible for using equipment with the correct lifting capacity to handle the Prefabricated Metal Footing Form. This can be accomplished by using the weights given for the prefabricated steel footing form in the Bill of Materials and by determining the lifting reach for the piece of lifting equipment that will be used to handle the units on site. Site conditions must be evaluated prior to shipping to ensure proper equipment location and to avoid any lifting restrictions. The lifting ports provided in each unit are the only means to be used to lift the elements, all (4) lifting ports should be utilized.

8.2. Placement of Prefabricated Metal Footing Forms

The prefabricated steel footing forms shall be placed as shown on the plans. Special care shall be taken in setting the elements to the proper line and grade. Once the prefabricated steel footing forms are set, insert plastic caps into lifting ports to ensure no backfill/concrete is lost. Prefabricated steel footing forms shall be staked into the ground using the provided stakes. For installations on rock, concrete anchor bolts shall be drilled into the rock and used instead of the stakes. Consult with Contech Engineering for type of anchor bolt and procedure.

8.3. Backfill

8.3.1. Do not perform backfilling during freezing weather.

8.3.2. No backfill shall be placed against any structural elements until the steel footing location, grade, alignment and squareness has been approved by the Engineer.

8.3.3. The project construction and material specifications, which include the specifications for excavation for structures and roadway excavation and embankment construction, shall apply except as modified in this section.

8.3.4. Backfill material should be free of rocks, frozen lumps, and foreign material that can cause hard spots or decompose to create voids. Backfill material should be well graded granular material that meets the requirements of AASHTO M 145 for soil classification A-1, A-2-4, A-2-5 or A-3, at a minimum.

8.3.4.1. Backfill around sides of Prefabricated Steel Footing Forms shall be performed prior to setting structure on foundation. The backfill material shall meet the specifications and compacting procedures equal to that for normal road embankments.

8.3.4.2. The site soils engineer shall review gradations of all interfacing materials and, if necessary, recommend geotextile filter fabric (provided by contractor).

8.3.5. Placing and Compacting Backfill – Dumping for backfilling is not allowed any nearer than 3 ft from the prefabricated metal footing forms.

The fill must be placed and compacted in layers not exceeding 12 inches uncompacted.

The backfill shall be compacted to a minimum 90% density per AASHTO T-180.

Hand equipment may be used to compact next to the foundations, within 3'-4'. Small tracked vehicles (D4 or smaller) should remain at least 3'-4' away from the foundation.

8.4. Grouting (if required)

8.4.1. Grouting shall not be performed when temperatures are expected to go below 35° for a period of 72 hours.

8.4.2. Grout shall be non-metallic, non-shrink material, with a minimum 4,000 psi compressive strength.

8.4.3. If pouring concrete prior to setting the structure, keyway must be blocked out to allow for grouting once structure is set on finished concrete.

8.5. Cast-in-place Concrete

8.5.1. Cast-in-place concrete portion of Steel EXPRESS® Foundations shall be in accordance with the design requirements provided by the Engineer of Record notes on the foundation plan.

8.5.2. The footings shall be given a smooth float finish and shall reach 75% compressive strength prior to any backfilling of the structure.

8.6. Monitoring – The contractor shall check settlements and horizontal displacements of the foundations to ensure that they are within the allowable limit provided by the engineer. These measurements should give an indication of the settlements and deformations along the length of the foundations.

The first measurement should take place after the placement of all prefabricated metal footing forms, a second after completion of backfilling of the prefabricated metal footing forms, and a third after the superstructure is assembled, prior to pouring cast in place concrete. Further measurements may be made according to local conditions.

For more information, call Contech Engineered Solutions:

800-338-1122

www.ContechES.com

9100 Centre Point Drive, Suite 400

West Chester, Ohio 45069

Fax: (513) 645-7993

NOTHING IN THIS CATALOG SHOULD BE CONSTRUED AS A WARRANTY. APPLICATIONS SUGGESTED HEREIN ARE DESCRIBED ONLY TO HELP READERS MAKE THEIR OWN EVALUATIONS AND DECISIONS, AND ARE NEITHER GUARANTEES NOR WARRANTIES OF SUITABILITY FOR ANY APPLICATION. CONTECH MAKES NO WARRANTY WHATSOEVER, EXPRESS OR IMPLIED, RELATED TO THE APPLICATIONS, MATERIALS, COATINGS, OR PRODUCTS DISCUSSED HEREIN. ALL IMPLIED WARRANTIES OF MERCHANTABILITY AND ALL IMPLIED WARRANTIES OF FITNESS FOR ANY PARTICULAR PURPOSE ARE DISCLAIMED BY CONTECH. SEE CONTECH'S CONDITIONS OF SALE (AVAILABLE AT WWW.CONTECHES.COM/COS) FOR MORE INFORMATION.

